

Short a Milk Cap Spelling Mats

Please visit [themeasuredmom.com](https://www.themeasuredmom.com) to learn how to use this printable:

<https://www.themeasuredmom.com/hands-on-phonics-for-kids-spell-with-milk-cap-letters/>

Thank you for respecting our Terms of Use



The unauthorized reproduction or distribution of a copyrighted work is illegal. Criminal copyright infringement, including infringement without monetary gain, is investigated by the FBI and is punishable by fines and federal imprisonment.

- **YOU MAY** use this file for your own personal, non-commercial use.
- **YOU MAY** print as many copies as you'd like to use in your classroom, home, public library, or tutoring setting.
- **YOU MAY** download this file by visiting <https://www.themeasuredmom.com>.
- **YOU MAY** save this file on your computer.
- **YOU MAY** share the link to the web page where the printable can be found.
- **YOU MAY NOT** link directly to the pdf file. Instead, link to the web page where it can be downloaded.
- **YOU MAY NOT** alter this file or claim this file as your own.
- **YOU MAY NOT** sell or in any way profit from this file. It is also illegal to print this file and sell the printed copy.
- **YOU MAY NOT** use this or any other printable from The Measured Mom on Outschoool.
- **YOU MAY NOT** e-mail this file OR store it on any location where others can download it (Amazon Inspire, Dropbox, Facebook groups and forums, etc.). If you would like to use this file for distance learning, please contact us directly for permission at <https://www.themeasuredmom.com/contact/>.

Check out these resources from the shop!

Short Vowel

WORD FAMILY MATS & GAMES



After you do the word family mat activity, a line from each picture to its name.

Roll & Read (ap)

Read & Race (ap)

cap

the measured mom

SHORT VOWEL

WORD SLIDER CARDS

CVC, CCVC, CVCC & CCVC WORDS



men

band

den

sand

hand

clock

knock

the measured mom

EDITABLE

SIGHT WORD GAMES

150 SEASONAL GAMES



FOLLOW THE PATH

TIC-TAC-TOE

SIGHT WORD BUMP

SNACKS & LADDERS

ROLL, READ & COVER

NO-PREP MATH & LITERACY GAMES

120 GAMES STUDENTS CAN PLAY ALONE OR IN PAIRS

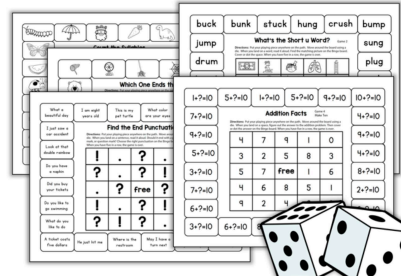

buck, bunk, stuck, hung, crush, bump, jump, drum, plug, sung

What's the Short a Word?

Which One Ends in ...?

Find the End Paragraph

Addition Facts

	4-7+0	5-7+0	1-7+0	5-7+0	6-7+0	10-7+0
4-7+0	4	7	9	1	0	4-7+0
5-7+0	3	2	5	8	3	4-7+0
3-7+0	5	7	free	1	6	8-7+0
7-7+0	4	6	8	5	1	2-7+0
6-7+0	9	2	4	6	7	4-7+0
3-7+0	6-7+0					

the measured mom

HANDWRITING

WORKSHEETS

GIANT BUNDLE OF 330 WORKSHEETS

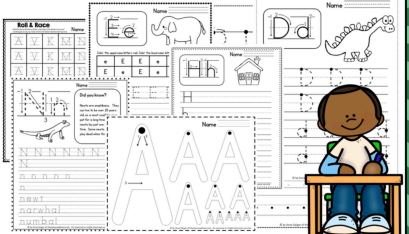

Roll & Race

the measured mom

Find me here

Blog: <https://www.themeasuredmom.com/>

Membership: <https://membership.themeasuredmom.com/>

Podcast: <https://www.themeasuredmom.com/triplerteachingpodcast/>

Teaching Every Reader course: <https://www.teachingeveryreader.com/>

Teaching Every Writer course: <https://www.teachingeverywriter.com/>

Facebook: <https://www.facebook.com/themeasuredmom/>

Pinterest: <https://www.pinterest.com/themeasuredmom/>

Instagram: <https://www.instagram.com/themeasuredmom/>

Contact: <https://www.themeasuredmom.com/contact/>

Printing trouble?

If the file is printing strangely (usually with extra black boxes), please download the free Adobe Reader to your computer. Open and print using that program. 99% of the time, this solves it!

You can get it here: <https://get.adobe.com/reader/>



You're invited to join The Measured Mom Plus!

- our membership site for Pre-K to 3rd grade educators -



- ✓ **Save hours of time** with our one-click printable library. You'll find hundreds of math and literacy resources for Pre-K through third grade.
- ✓ Get **free no-print resources** that are perfect for at-home use and distance learning.
- ✓ Recharge your teaching with on-demand **video workshops and mini-courses** that you can watch 24/7.
- ✓ **Save 33% on all products from The Measured Mom Shop.**

[LEARN MORE](#)



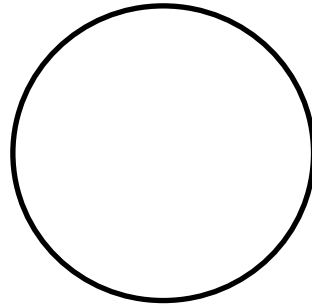
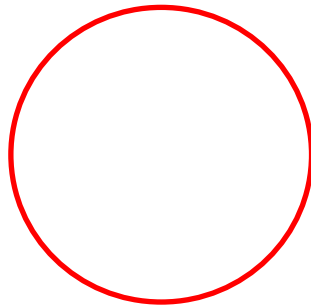
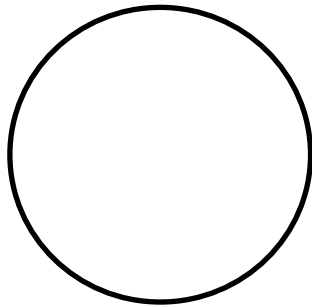
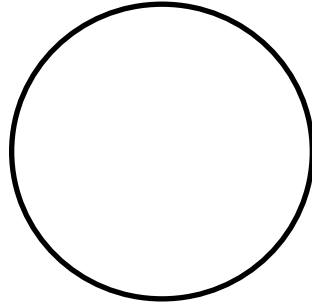
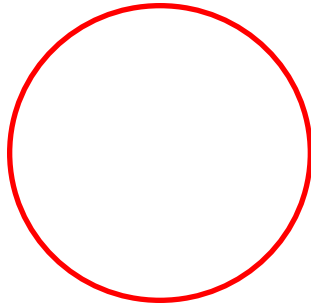
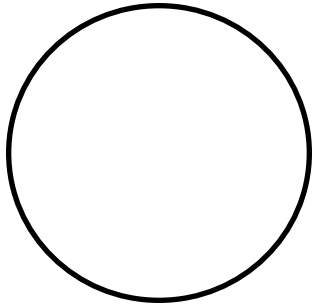



c

a

b



l

a

b

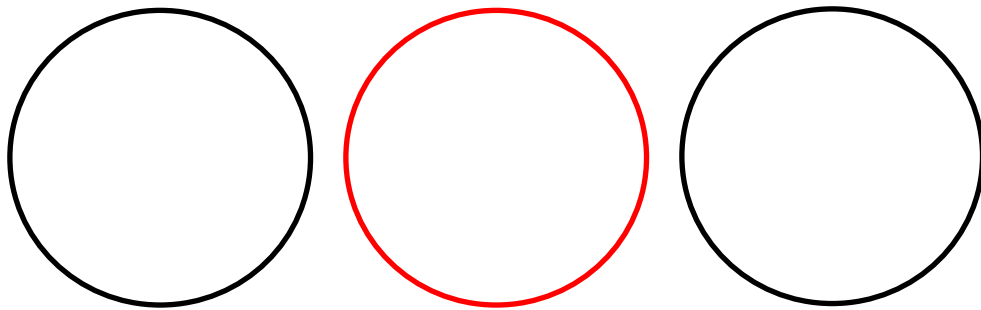
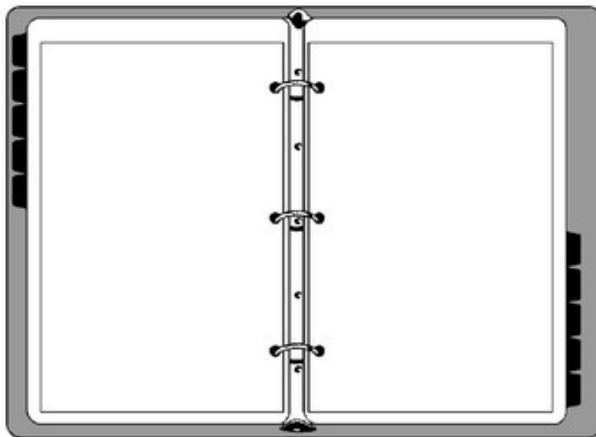
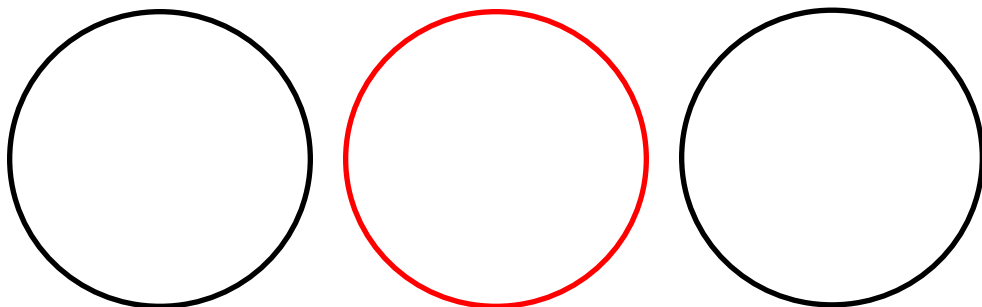



g

a

b

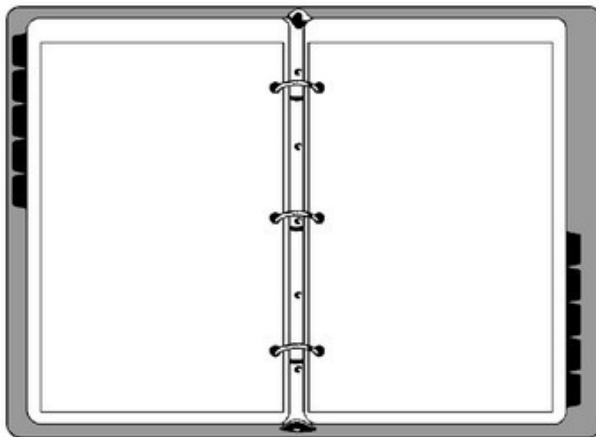

t

a

b

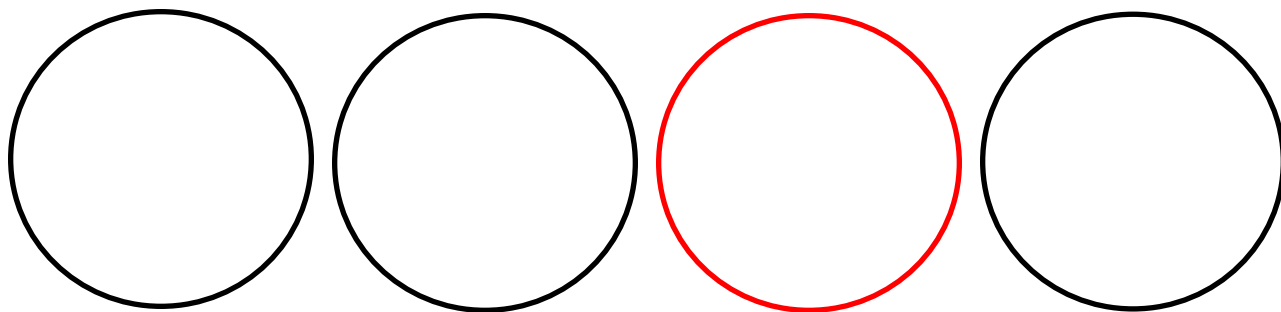

© 2014 themeasuredmom.com

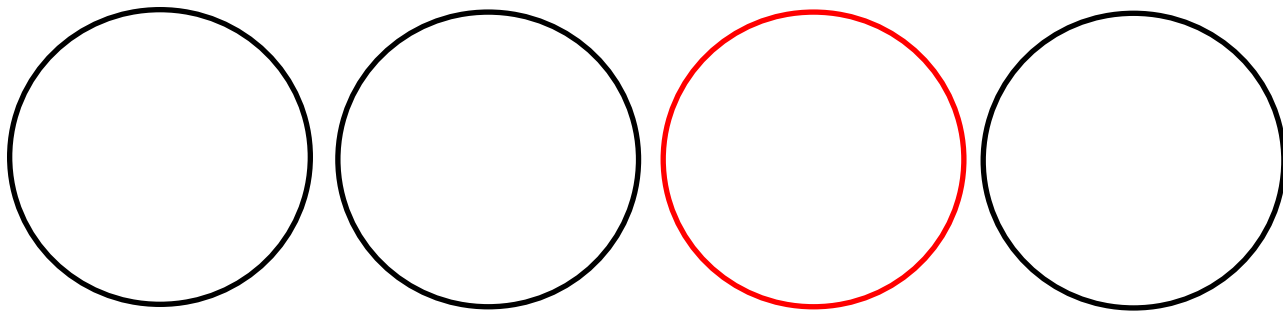
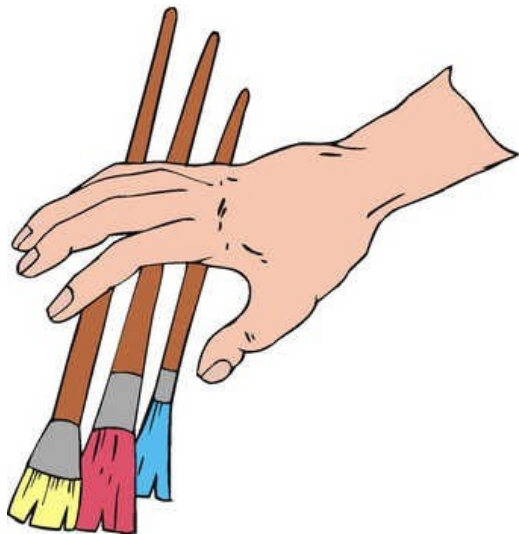

© 2014 themeasuredmom.com



c

r

a

b

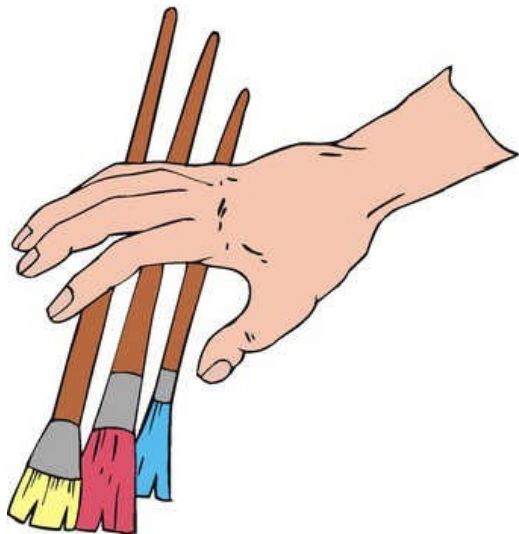

g

r

a

b

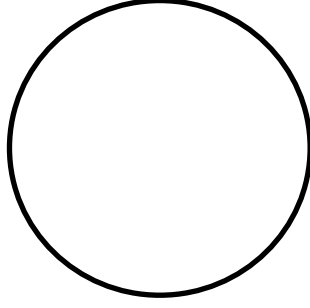
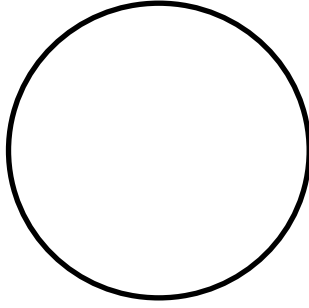
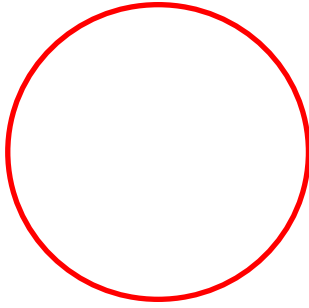
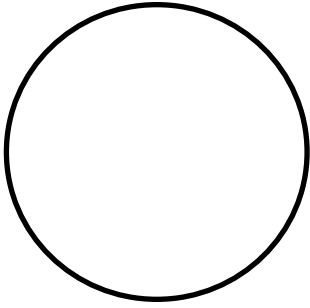
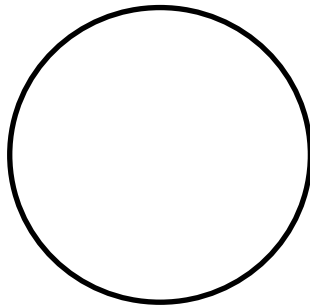
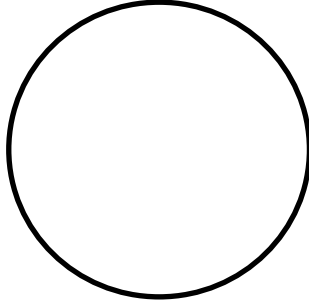
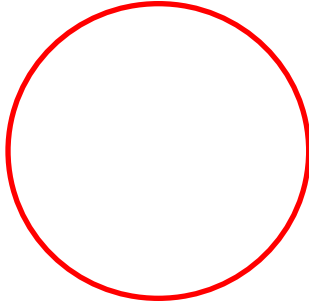
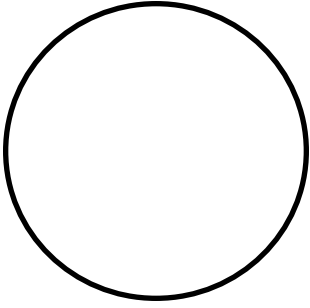



p

a

c

k

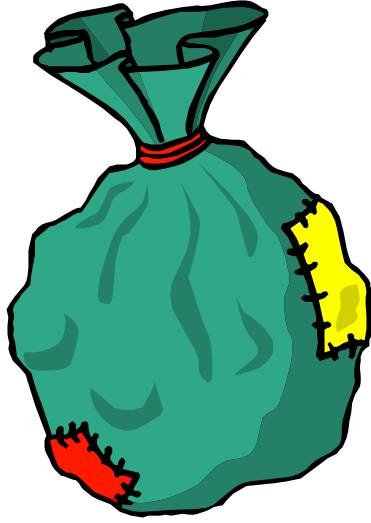

s

a

c

k

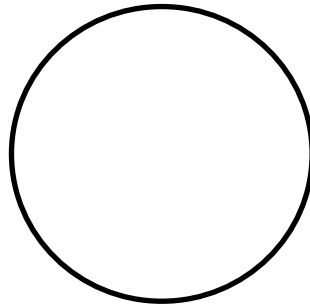
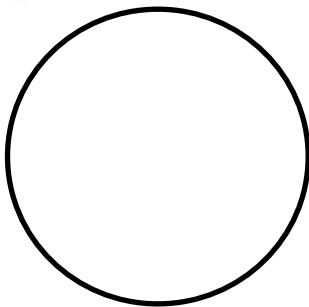
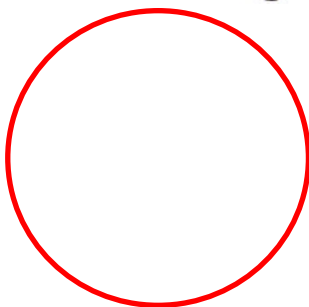
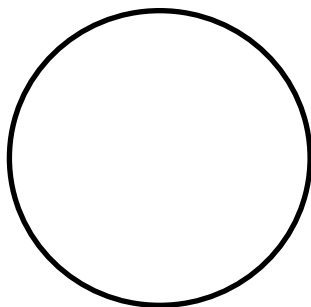
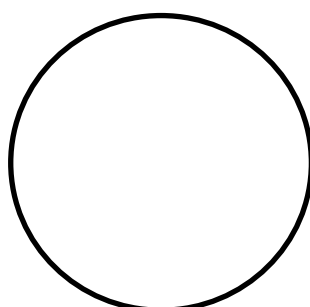
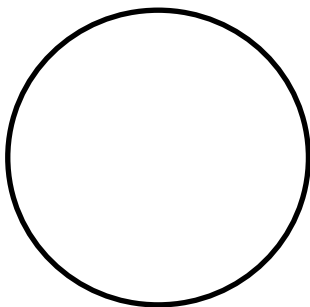
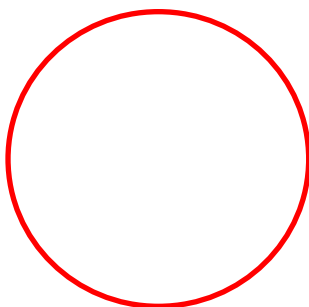
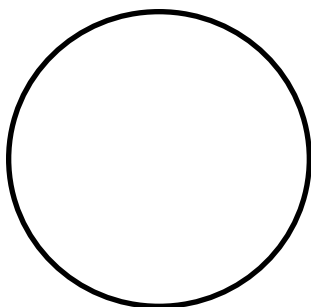
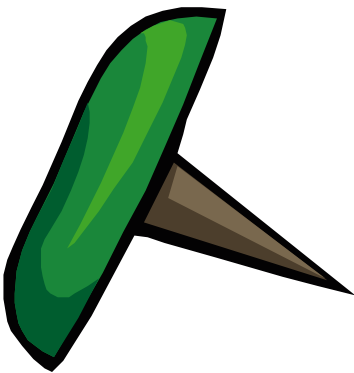



t

a

c

k



r

a

c

k

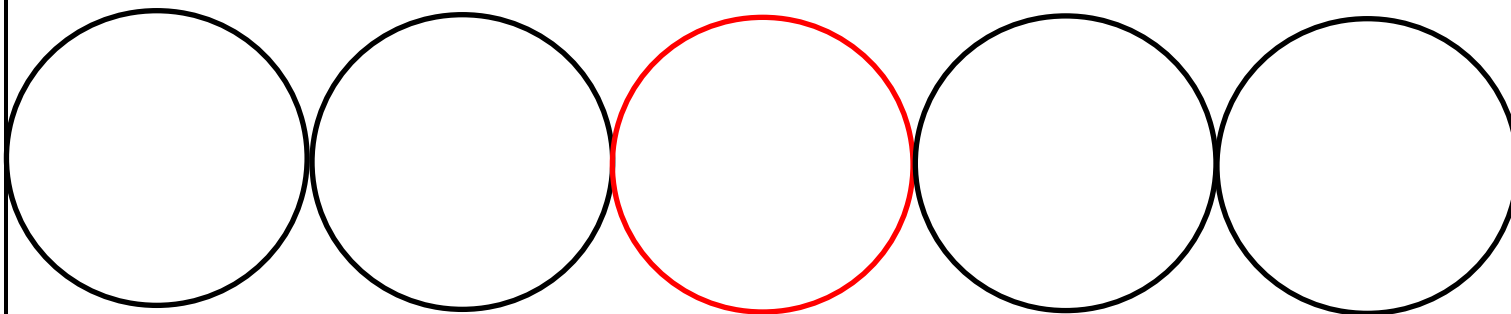
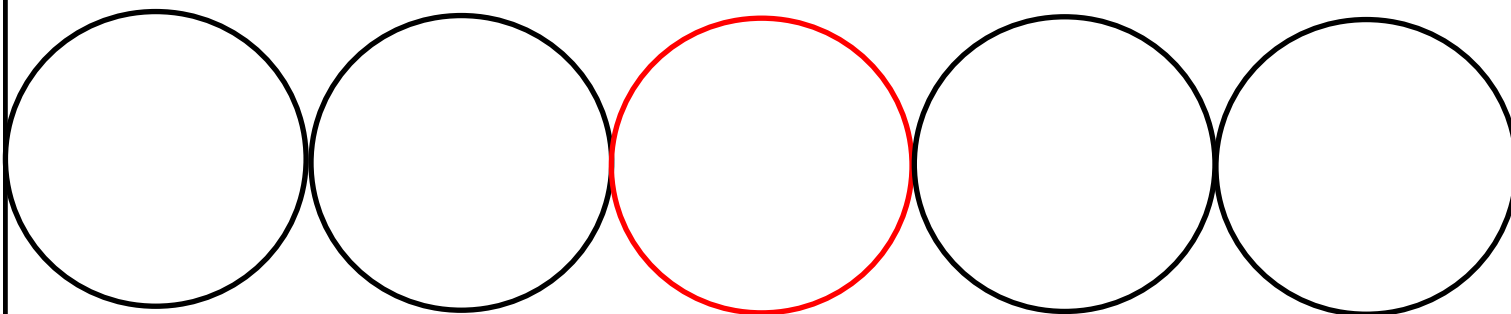



s

n

a

c

k



b

l

a

c

k

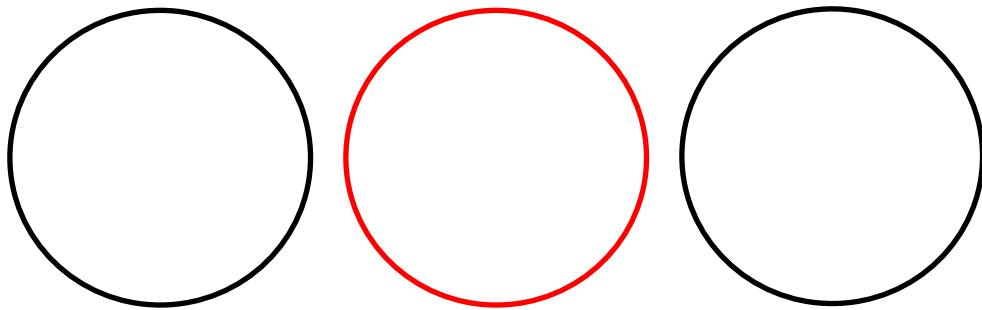
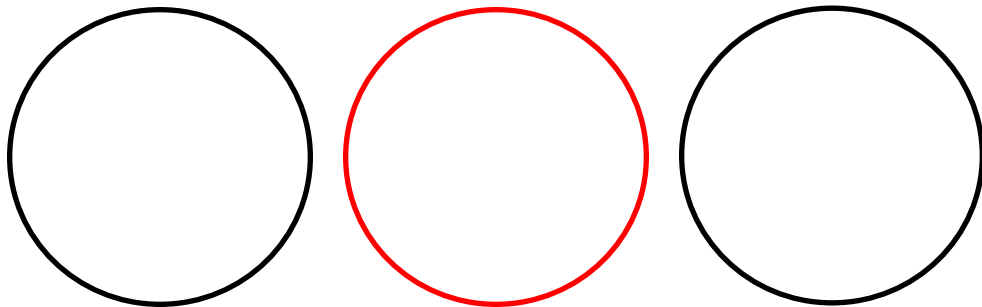
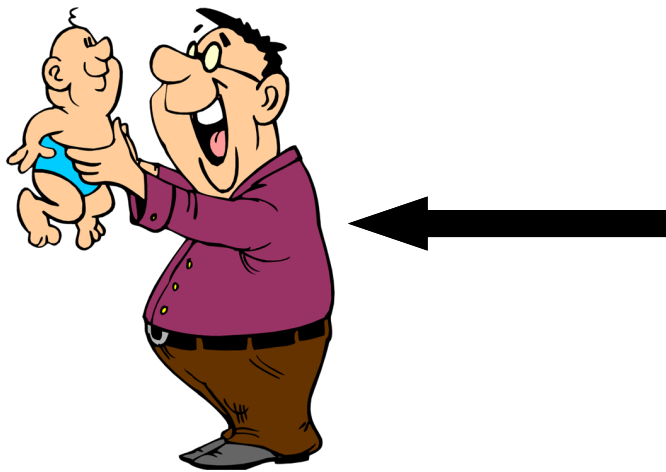



d

a

d



p

a

d

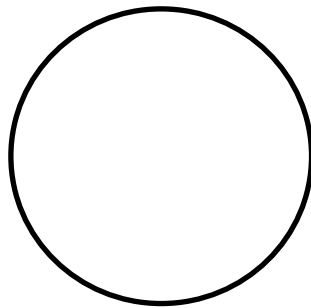
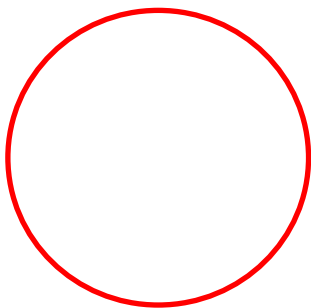
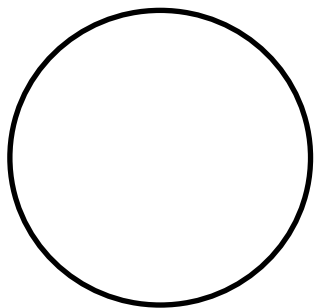
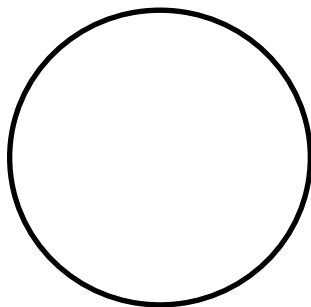
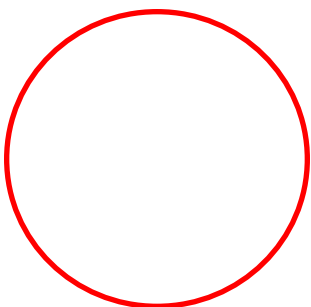
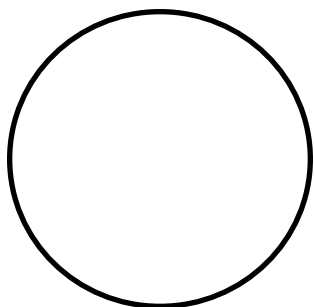



m

a

d



s

a

d

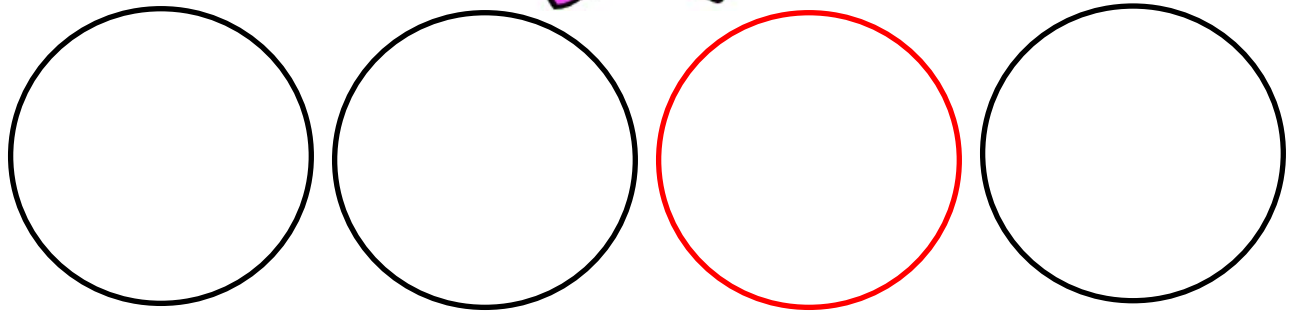
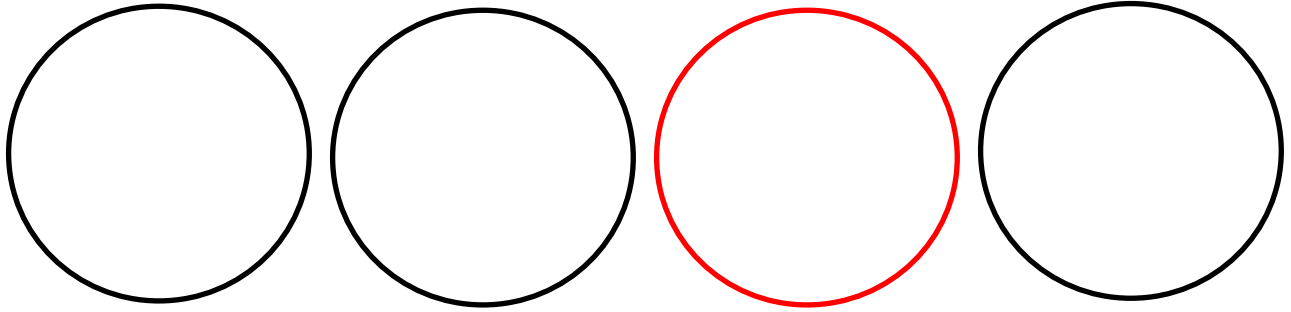



g

r

a

d



g

l

a

d

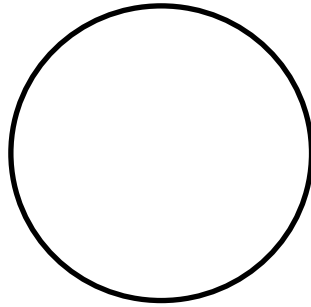
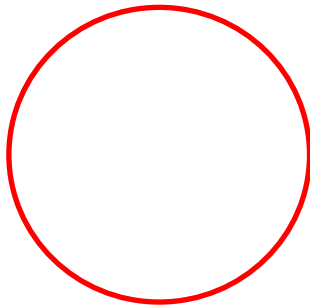
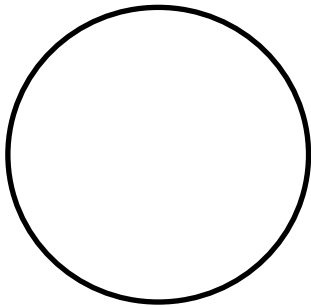
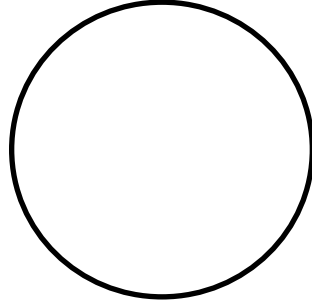
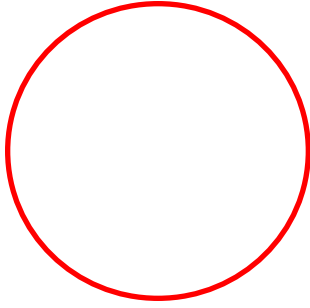
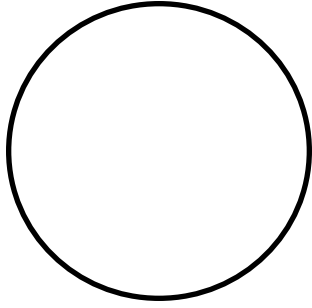
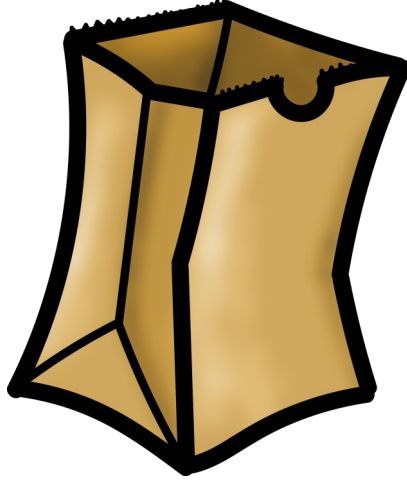

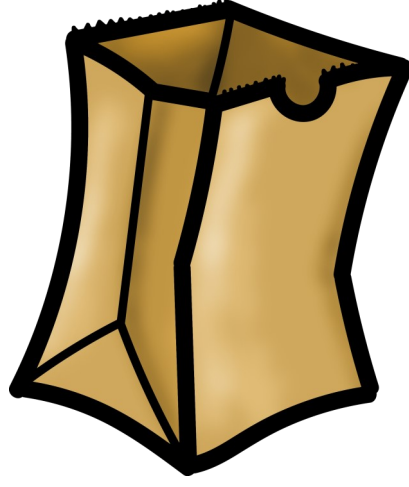

b

a

g



w

a

g

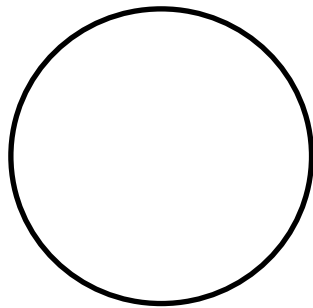
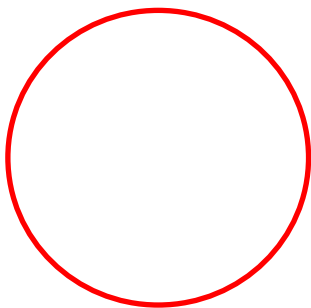
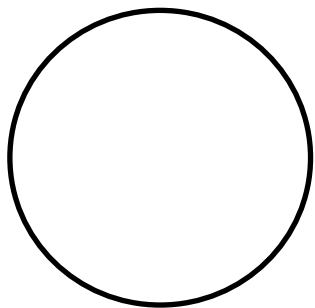
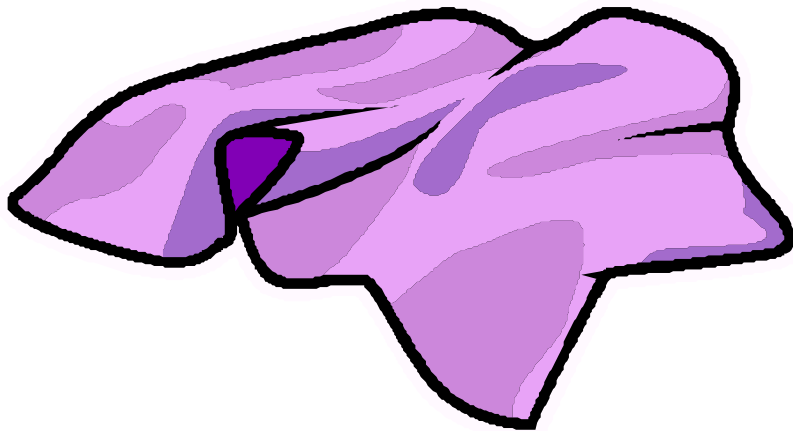
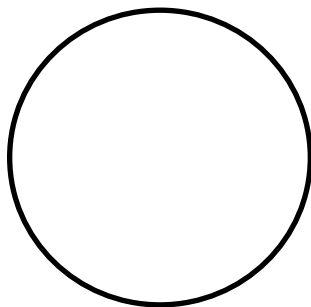
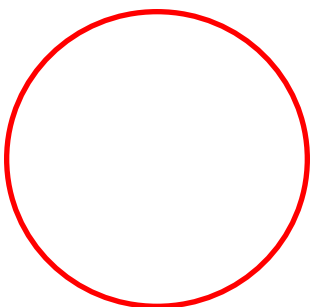
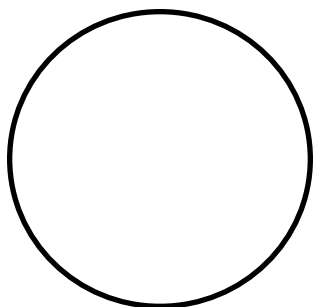



t

a

g

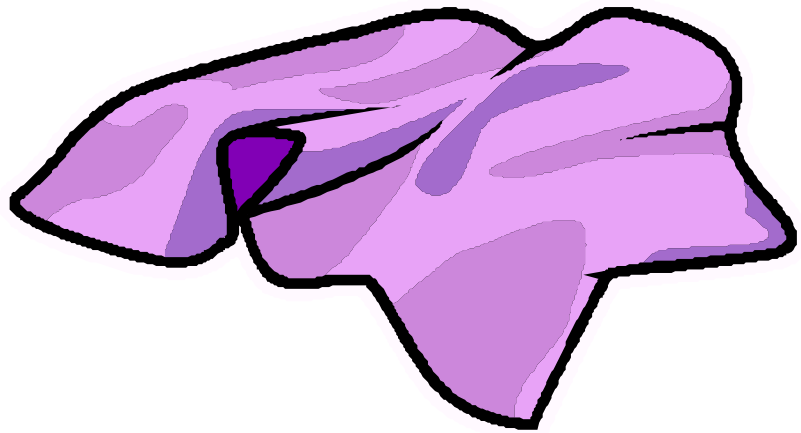

r

a

g

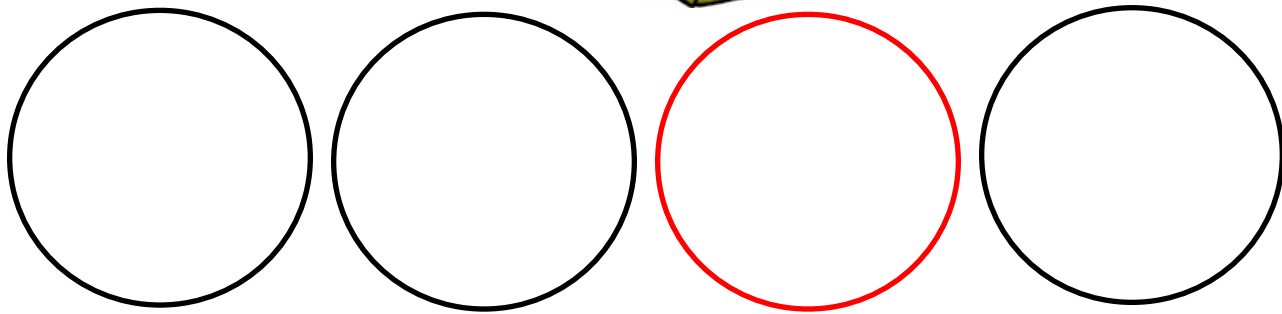
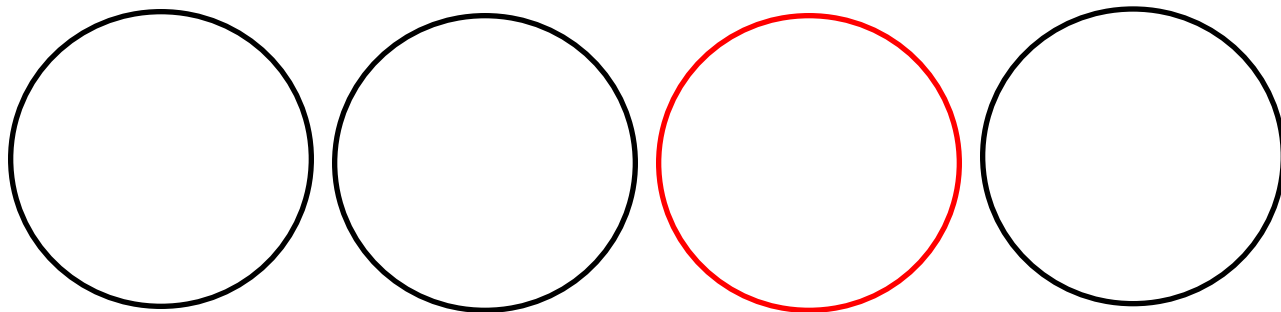
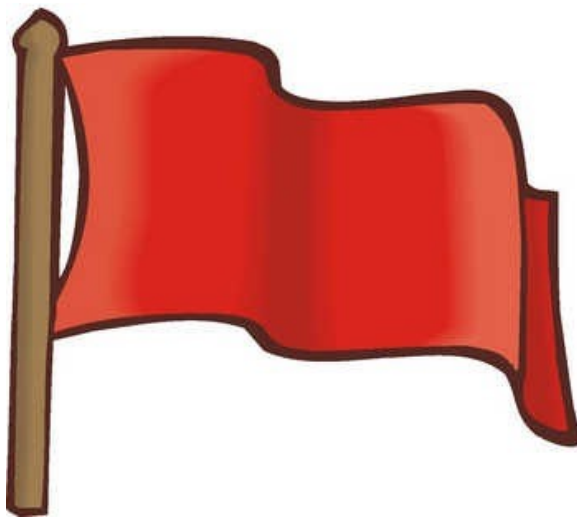

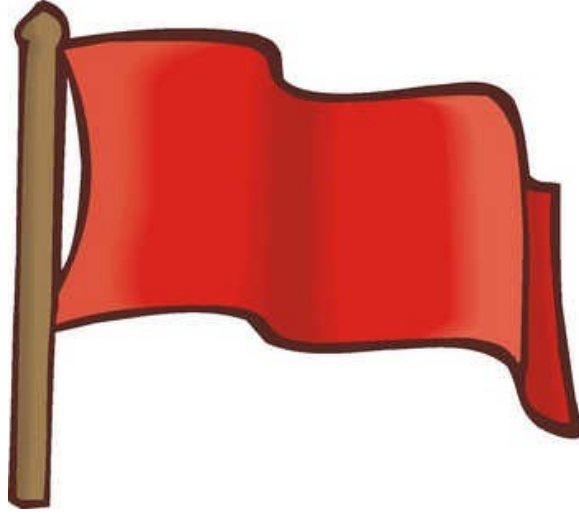

f

l

a

g



d

r

a

g

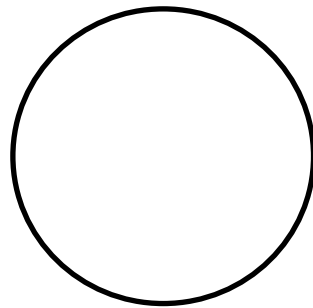
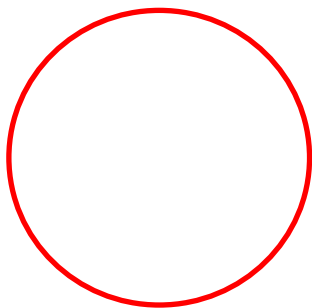
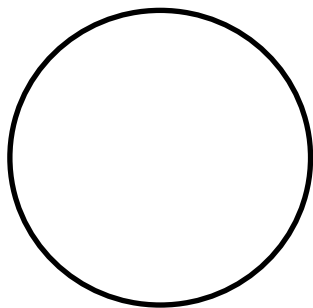
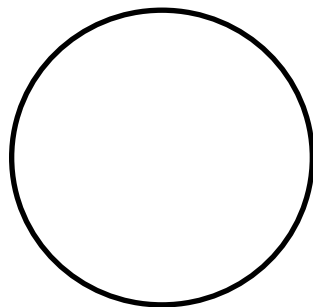
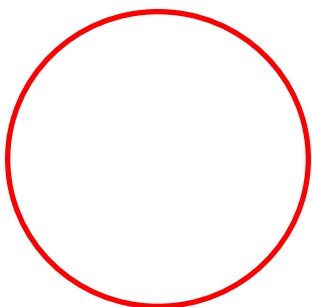
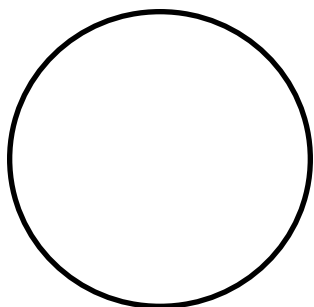



h

a

m



j

a

m

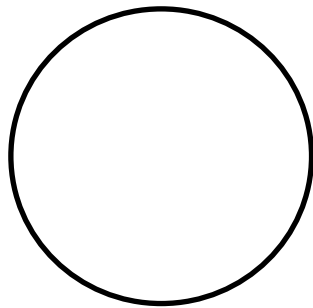
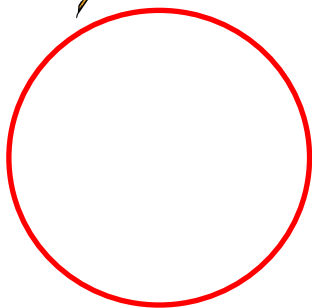
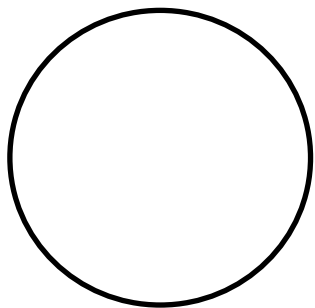
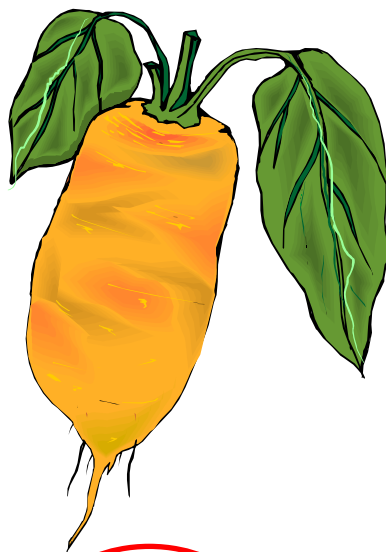
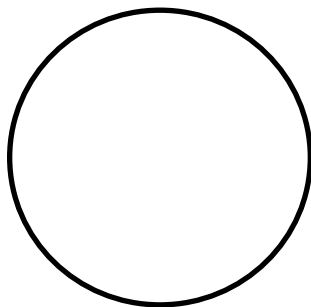
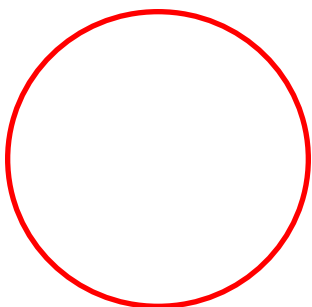
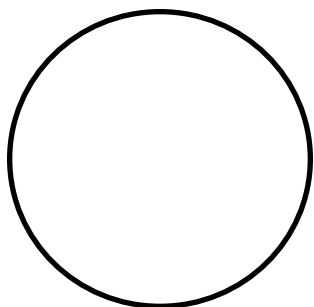

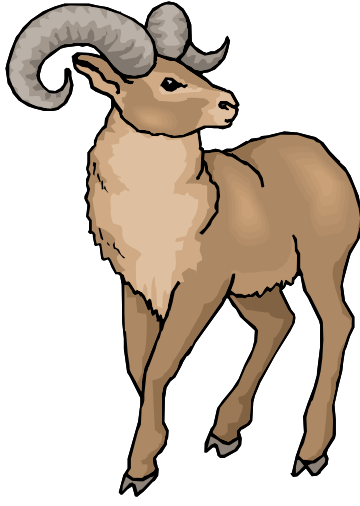

r

a

m

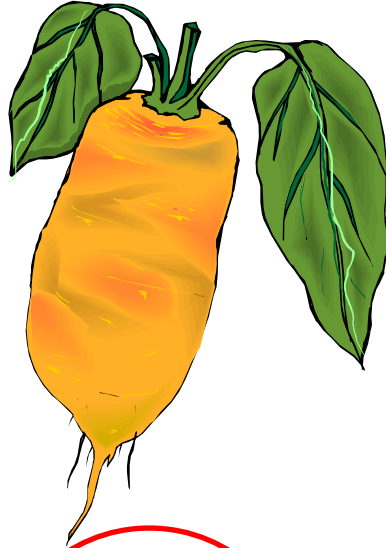

y

a

m

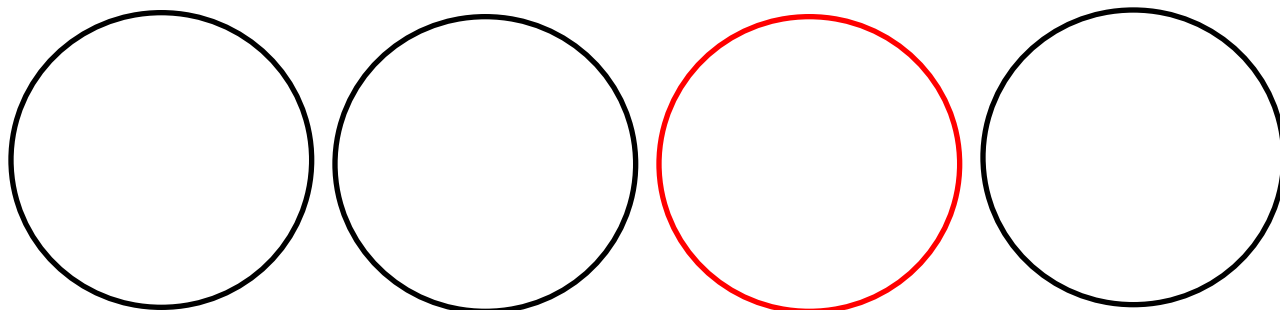
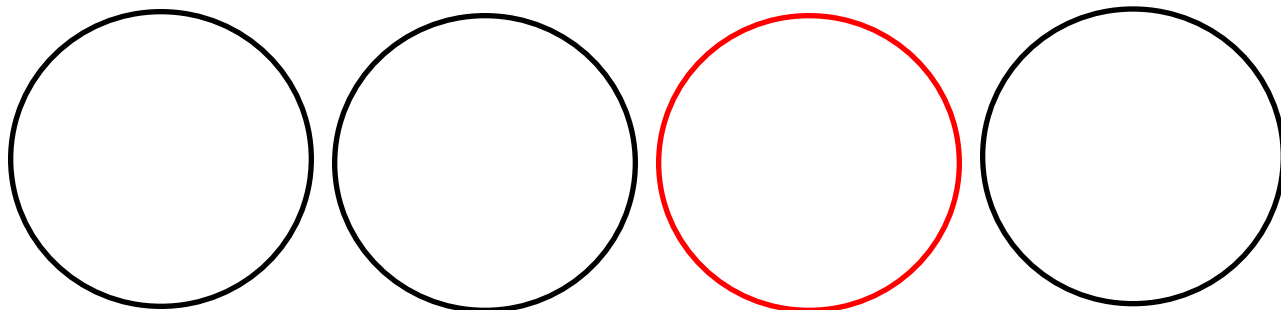
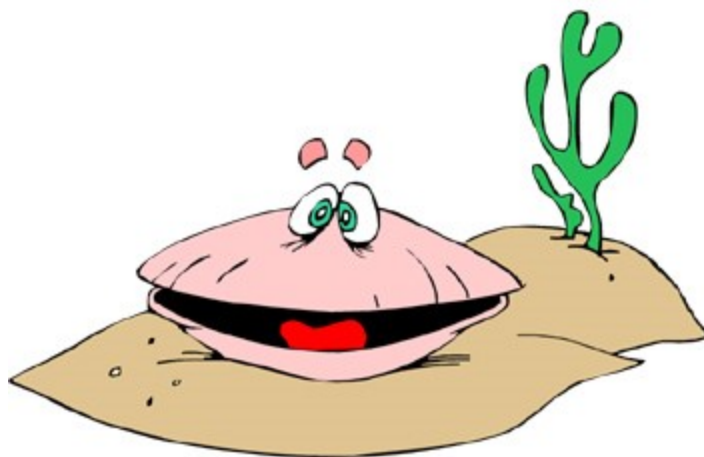



c

l

a

m



s

w

a

m

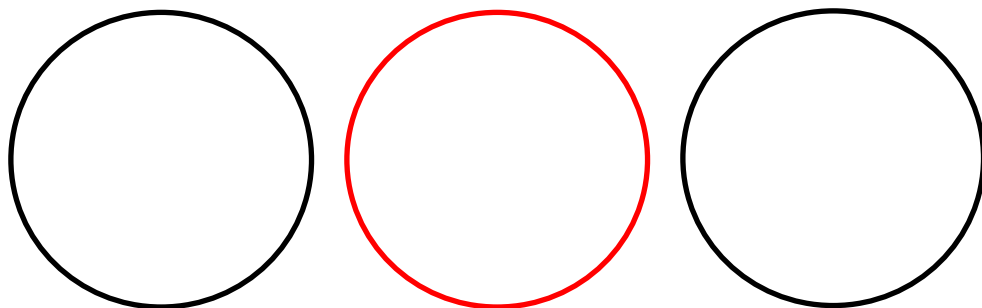
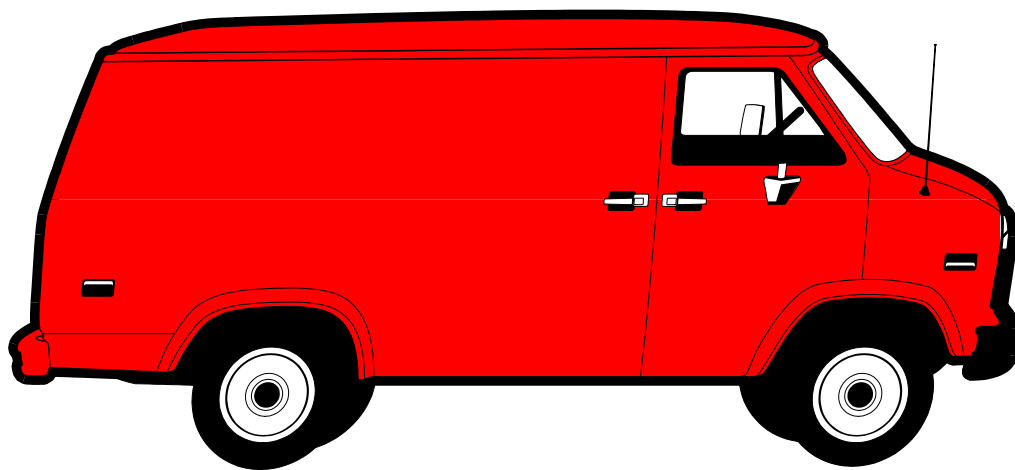
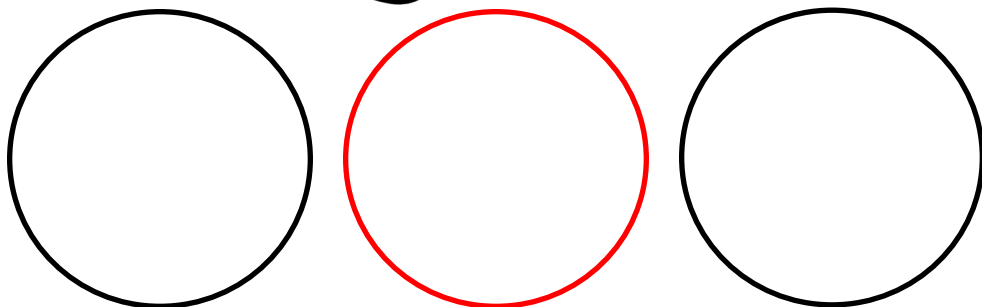
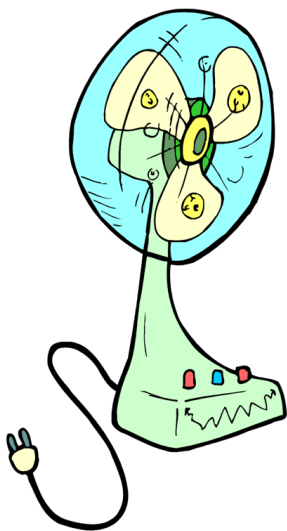

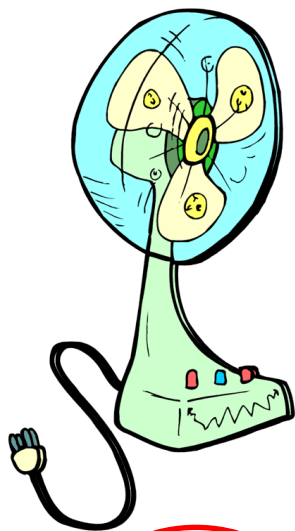

f

a

n

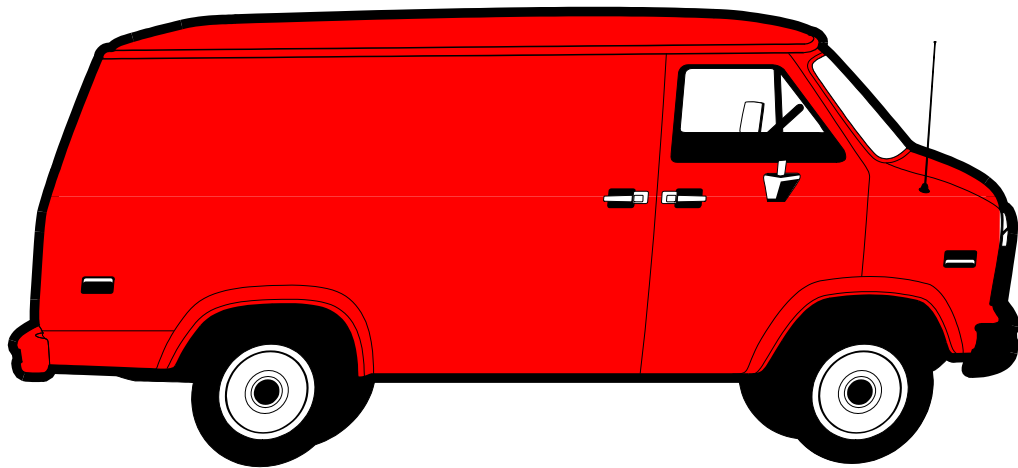

v

a

n

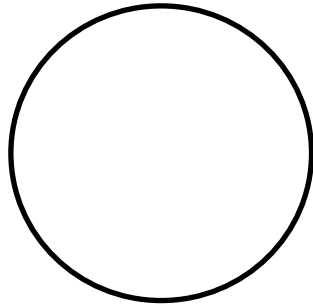
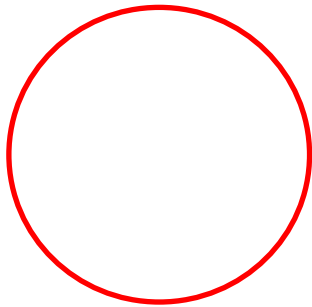
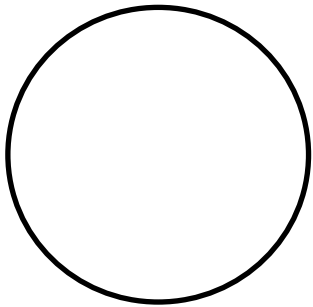
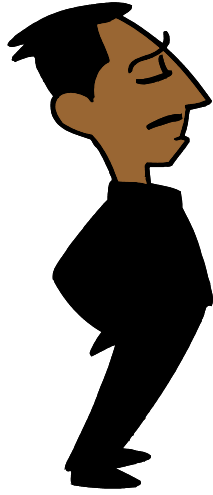
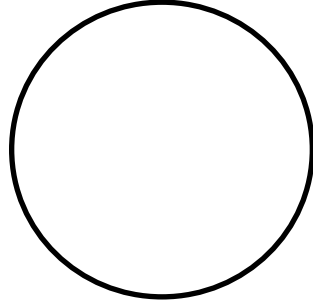
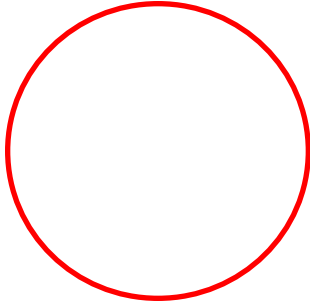
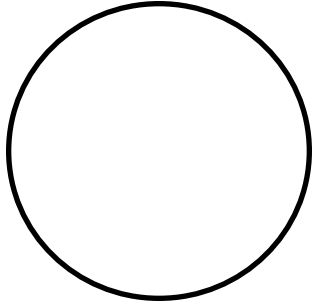



p

a

n

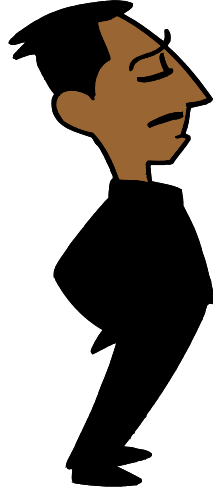

m

a

n

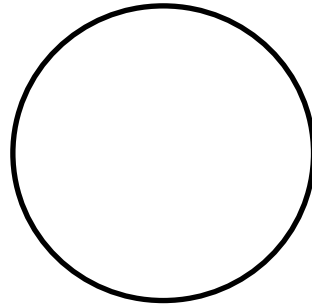
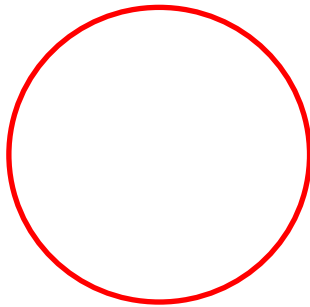
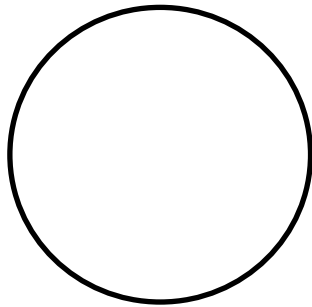
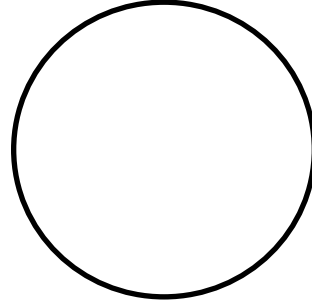
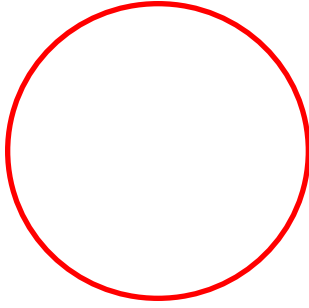
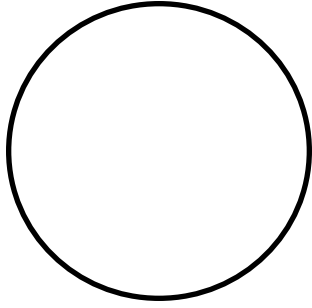
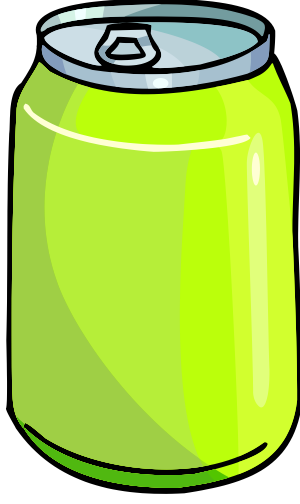

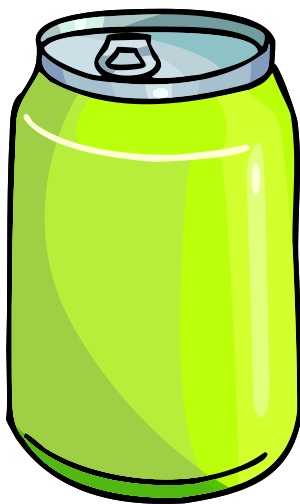

c

a

n



t

a

n

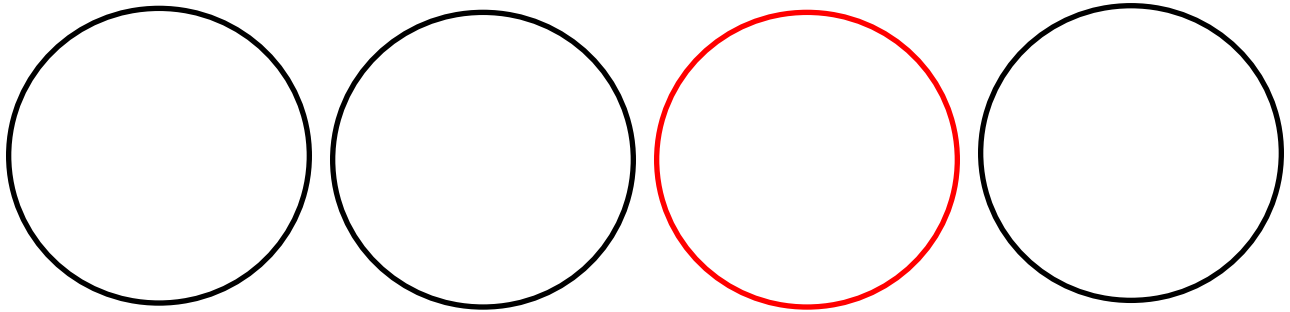
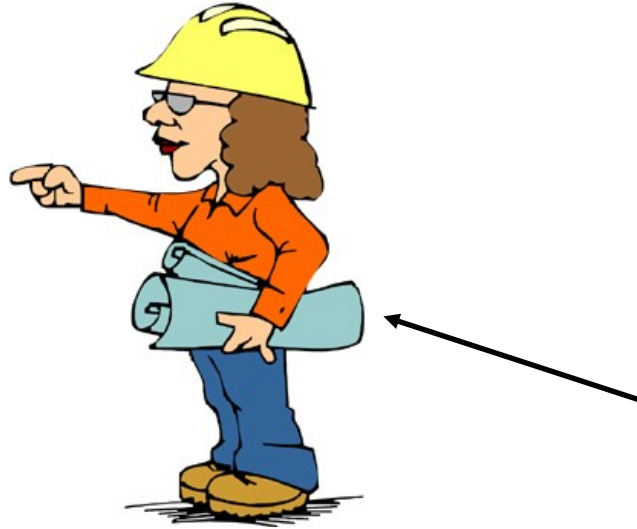
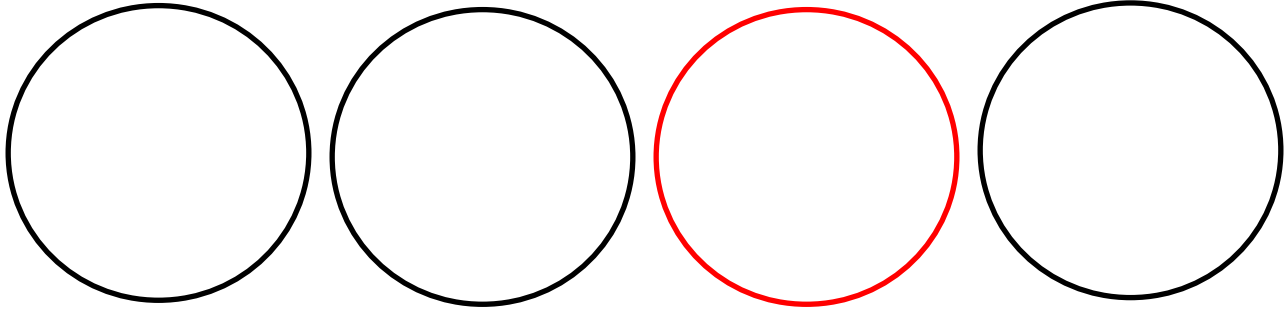



s

c

a

n

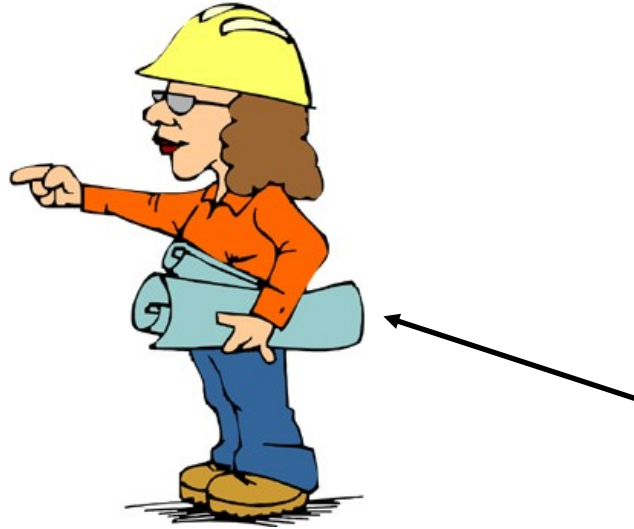

p

l

a

n

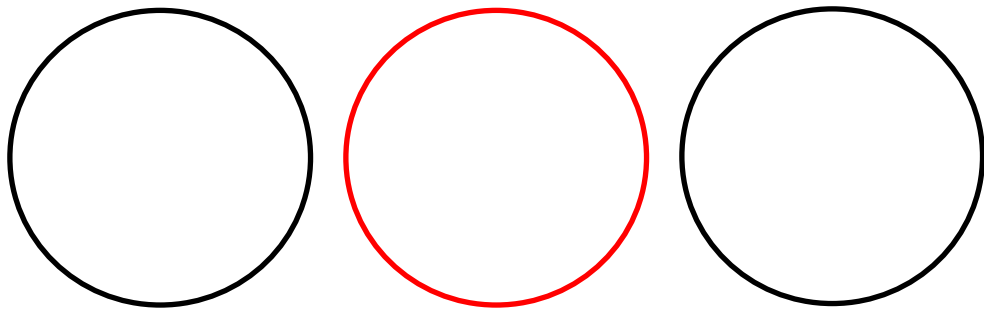
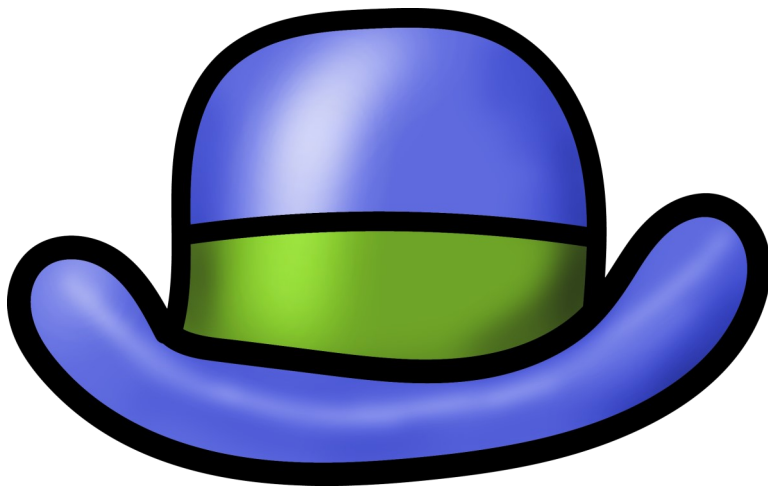
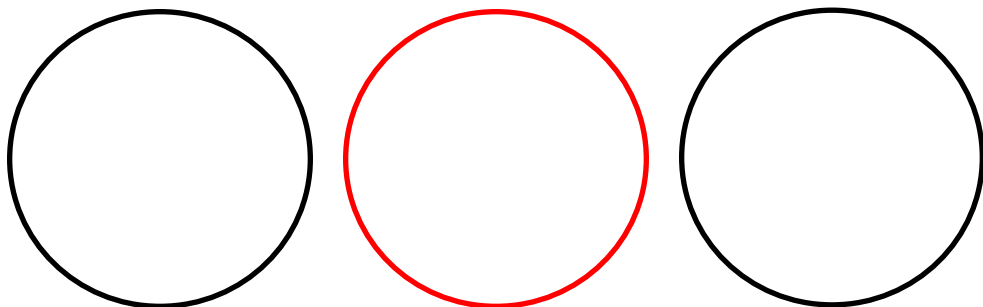
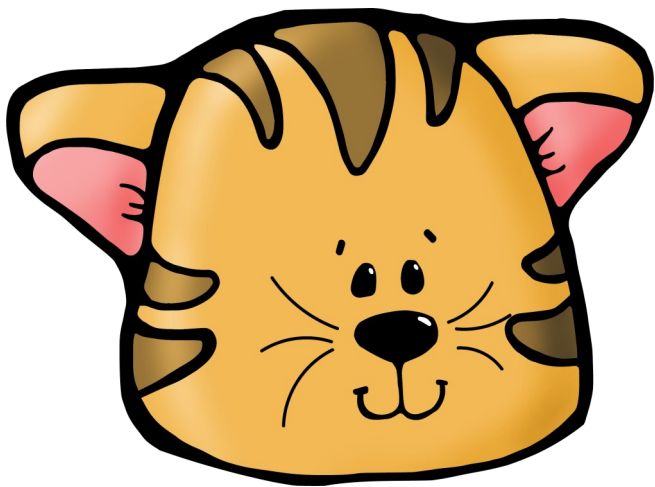

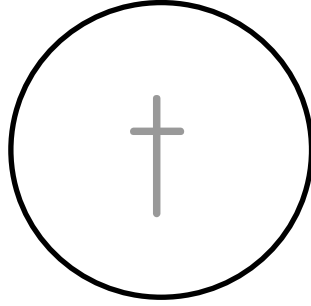
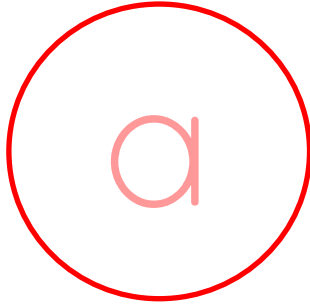
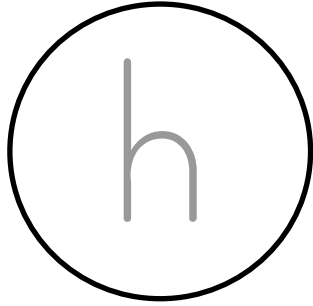
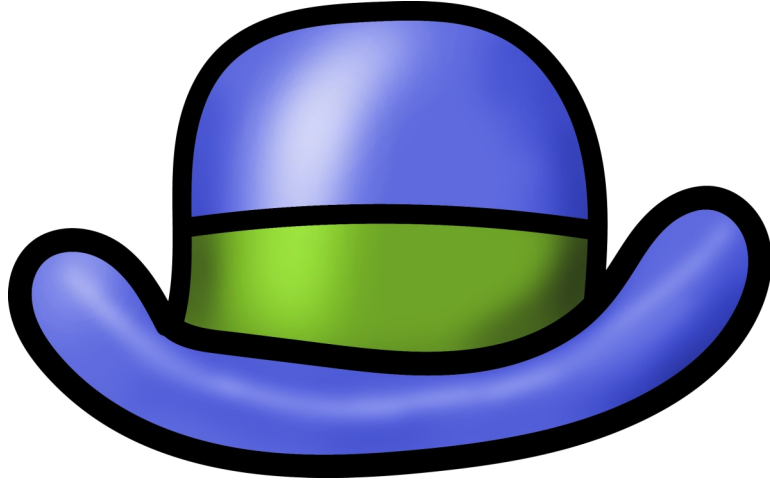
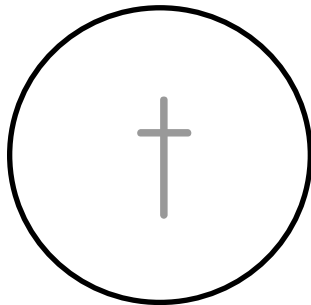
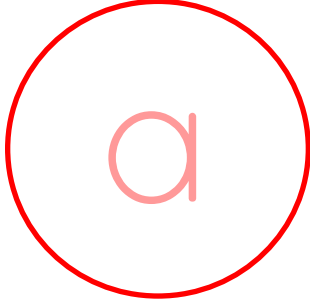
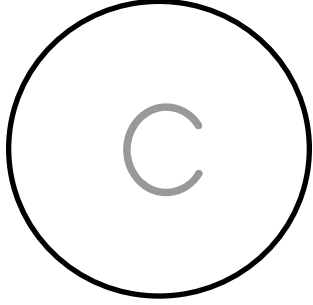
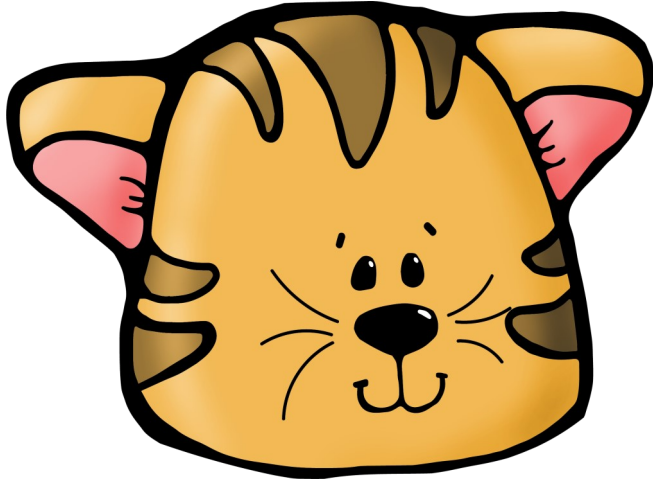

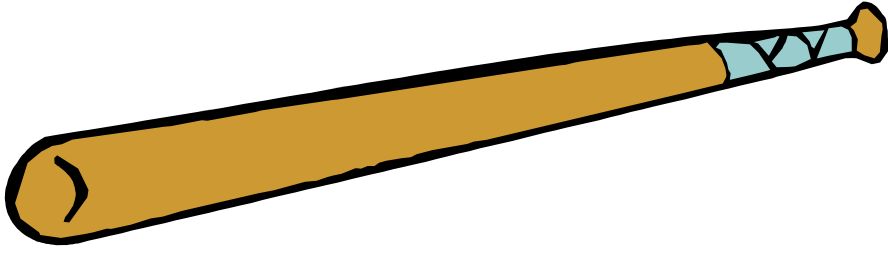
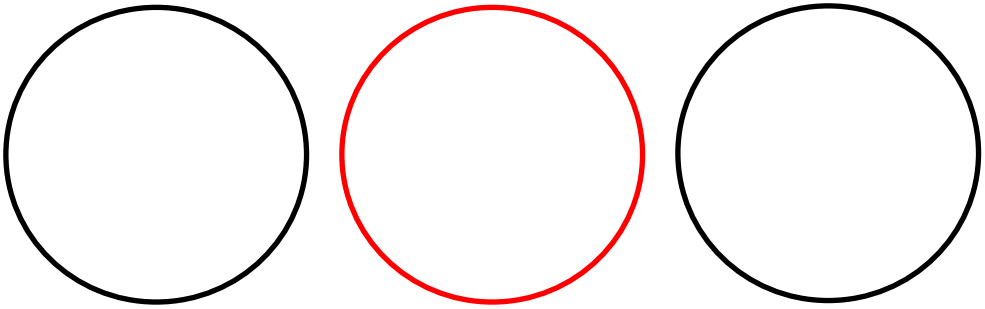
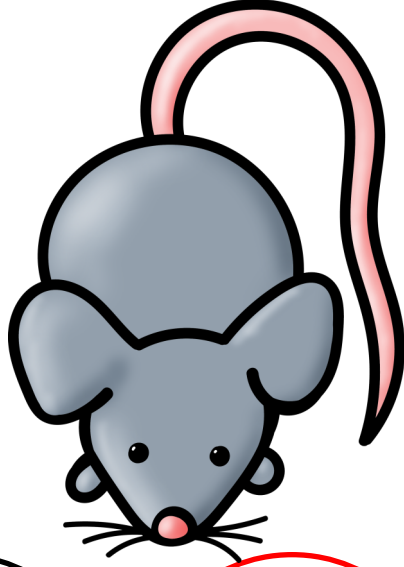
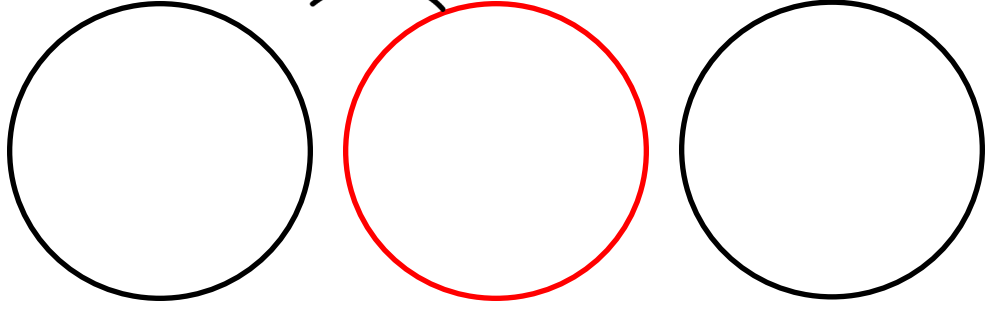

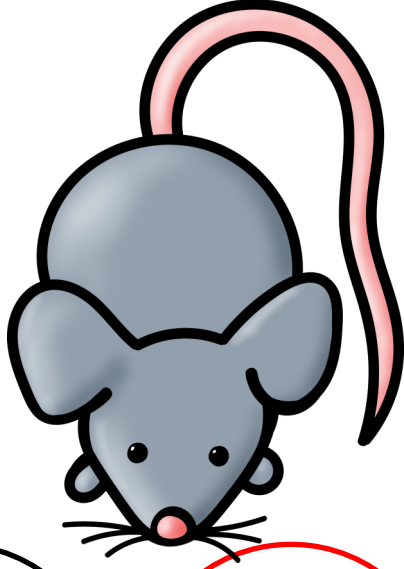

r

a

t

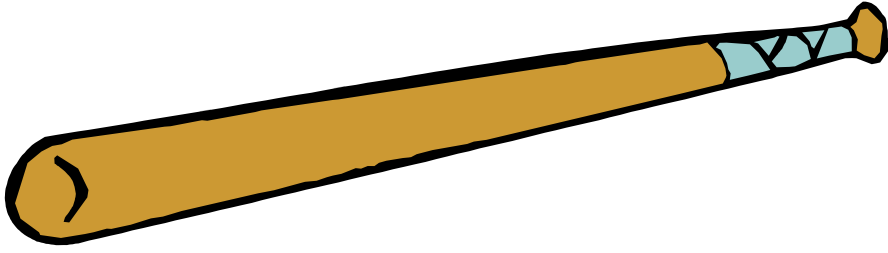

b

a

t

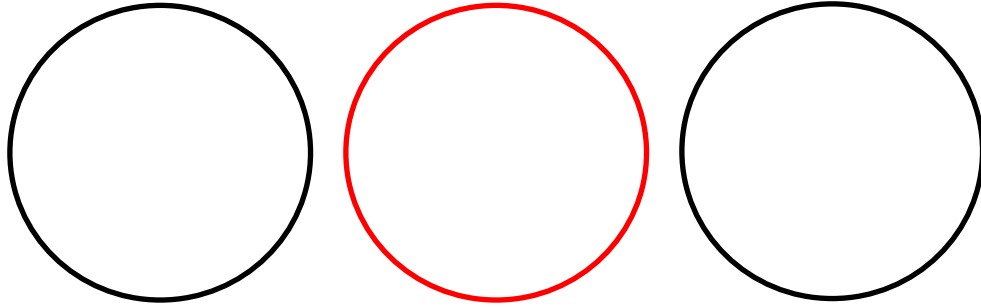
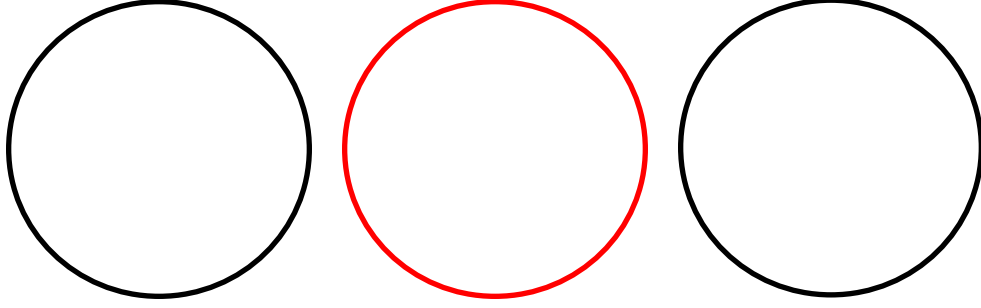
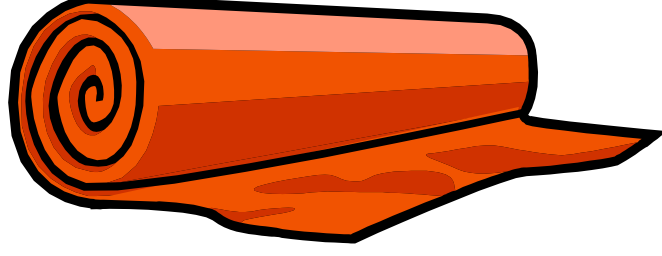

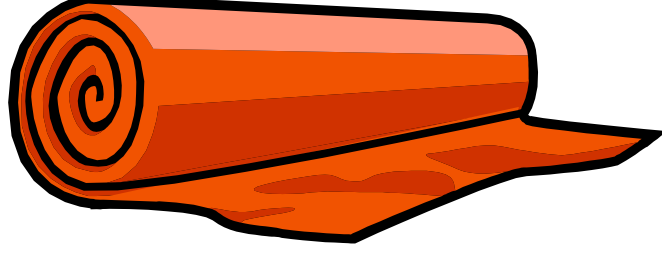

m

a

t



s

a

t

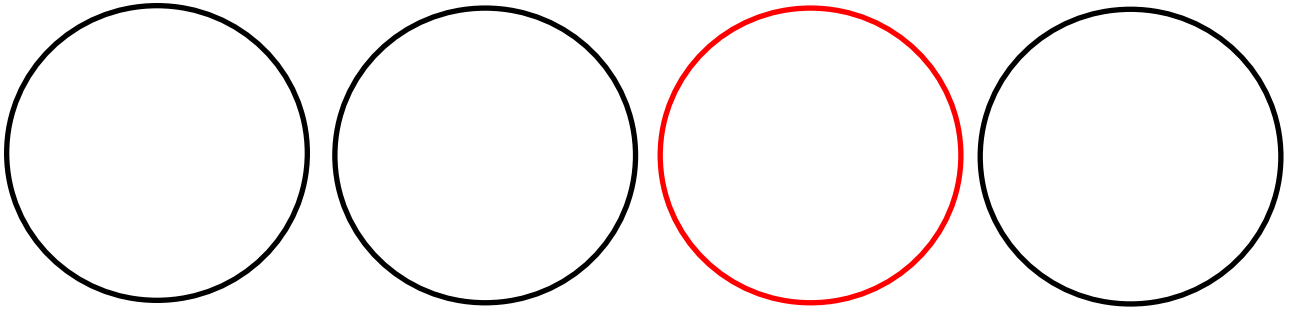
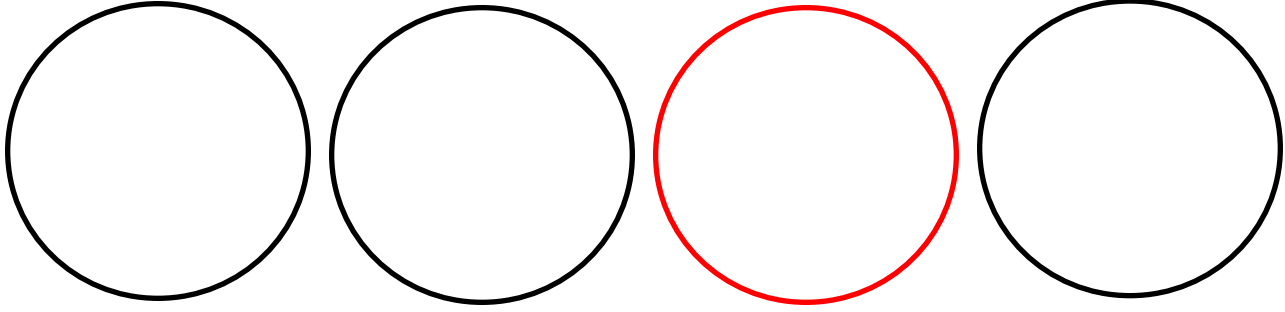



c

h

a

t



f

l

a

t

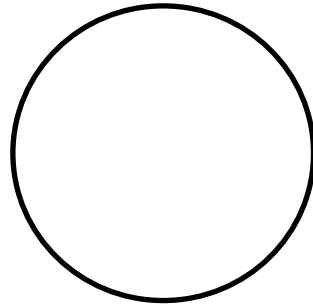
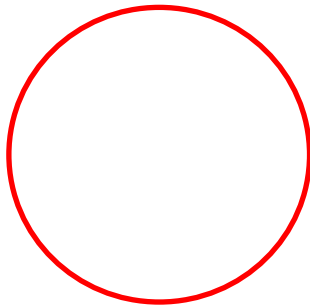
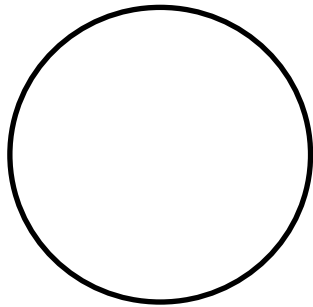
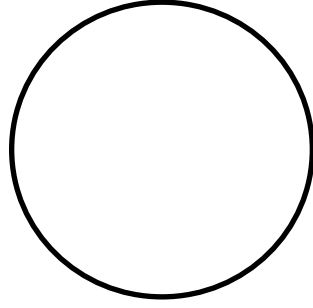
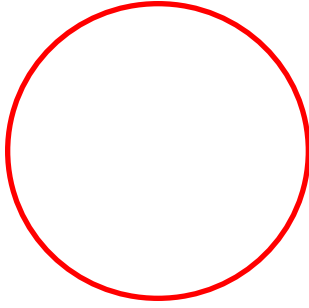
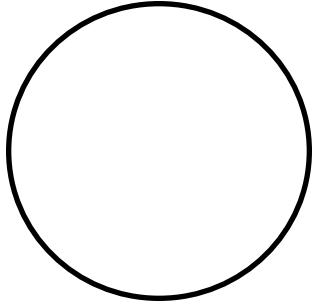
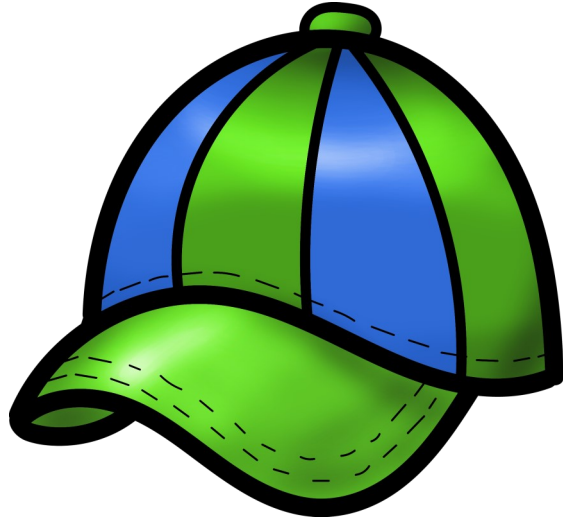

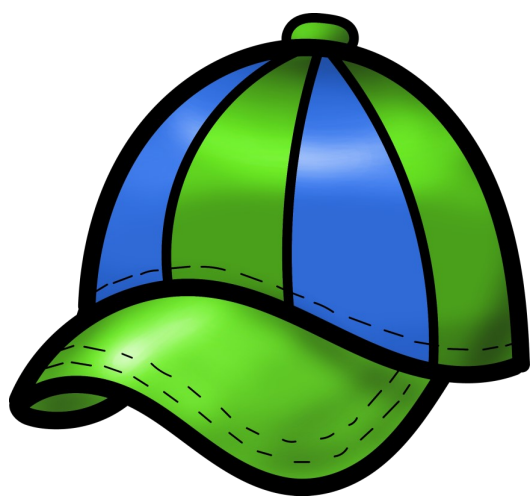

c

a

p



m

a

p

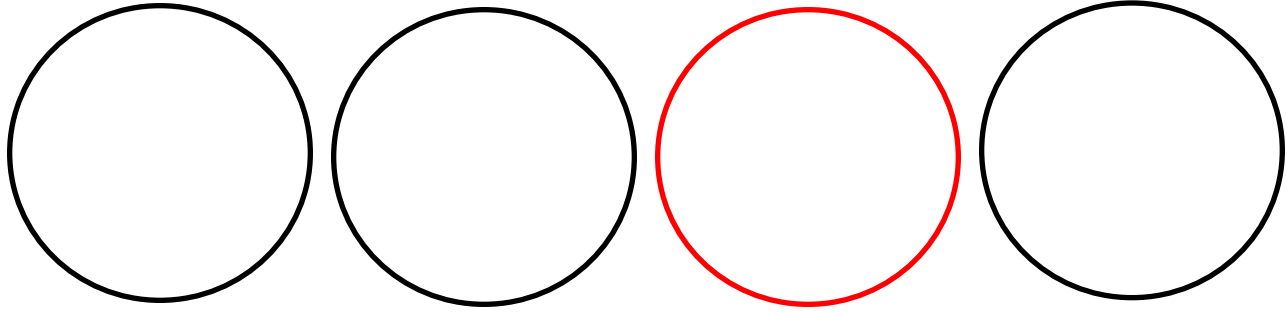
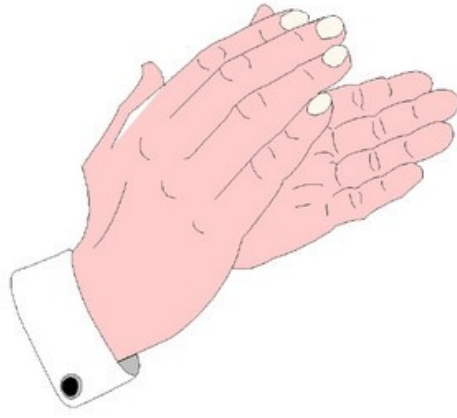

© 2014 themeasuredmom.com

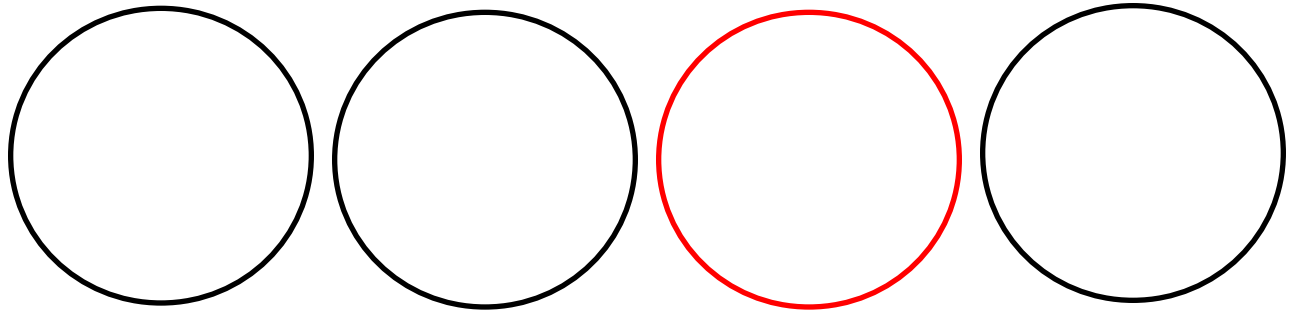
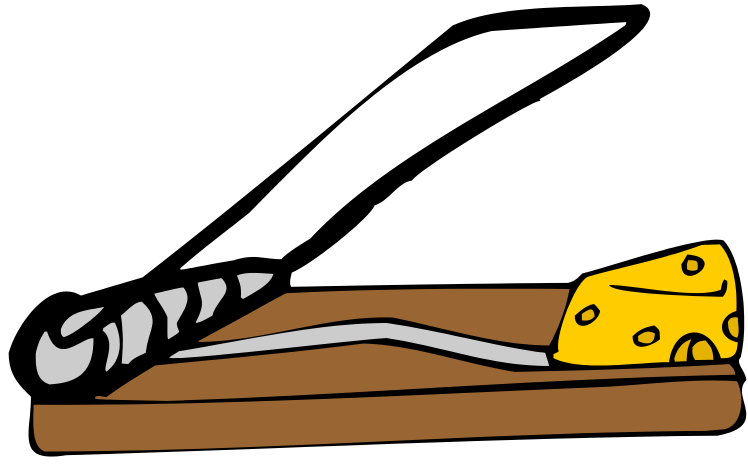

© 2014 themeasuredmom.com

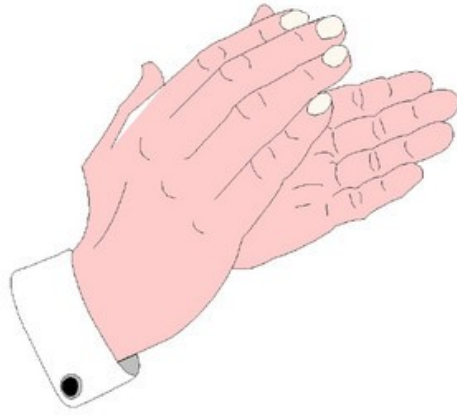

c

l

a

p

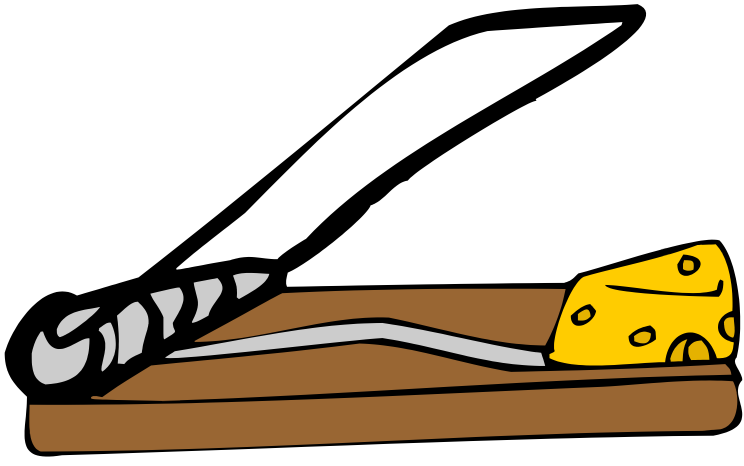

t

r

a

p

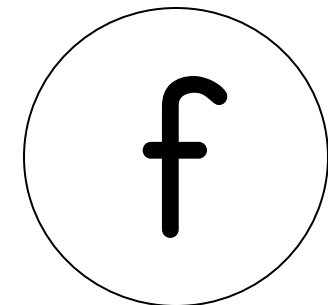
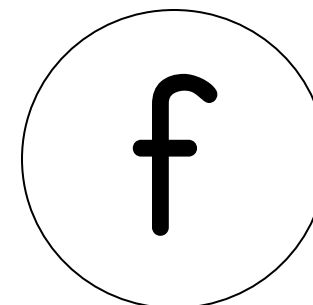
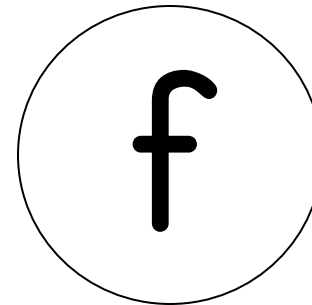
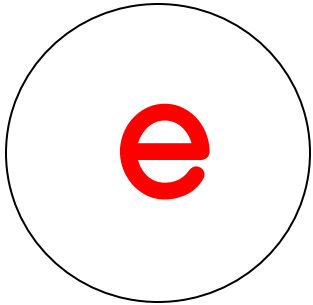
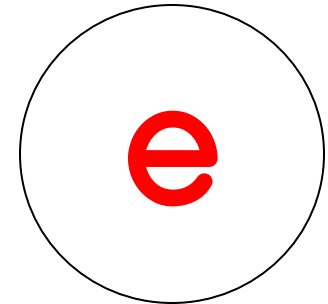
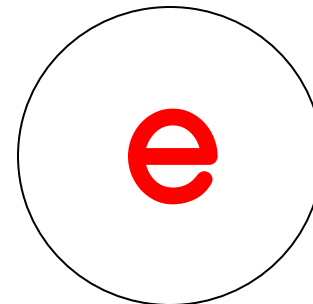
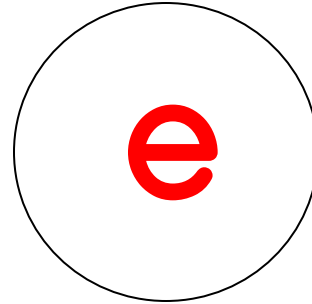
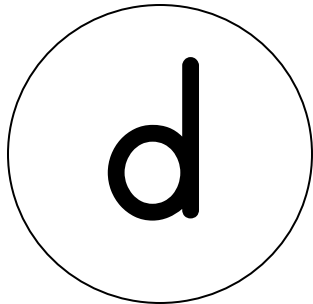
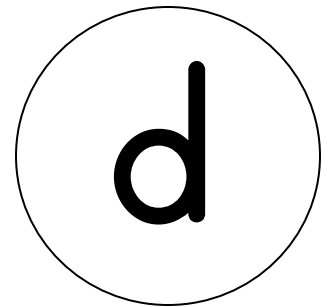
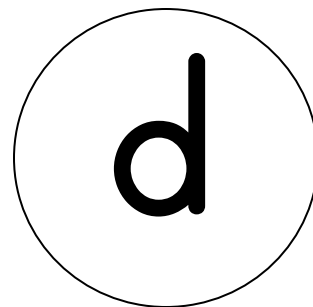
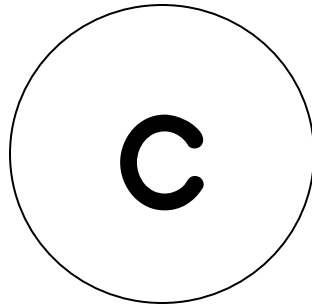
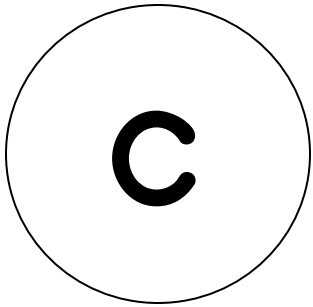
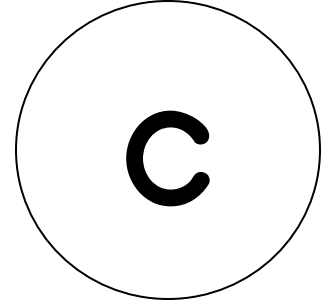
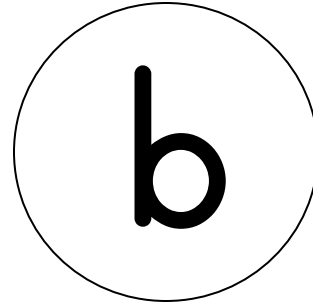
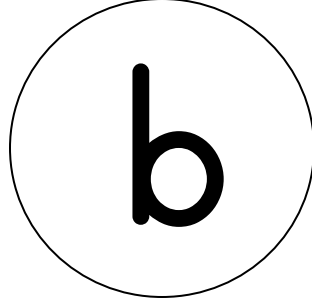
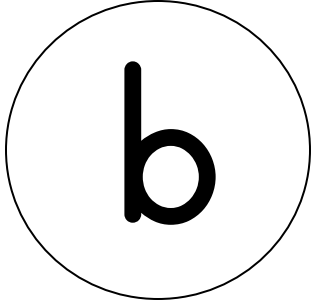
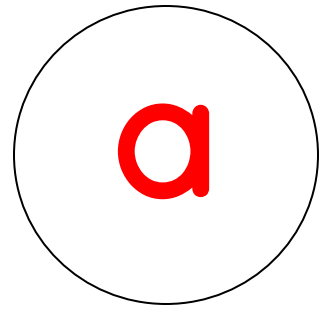
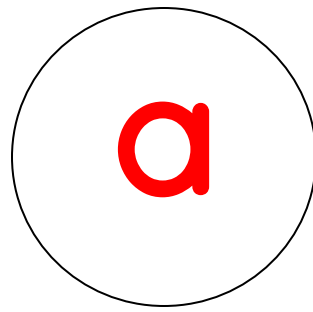
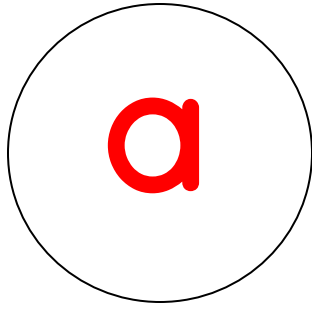
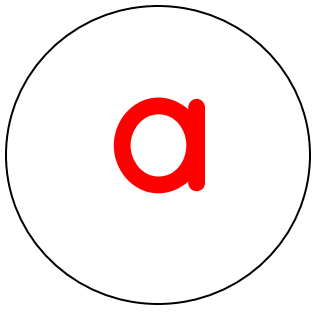

g

g

g

h

h

h

i

i

i

i

j

j

j

k

k

k

l

l

l

m

m

m

n

n

n

o

o

o

o

p

p

p

q

q

r

r

r

s

s

s

