

Number Book: Things that Go

Please visit [themeasuredmom.com](https://www.themeasuredmom.com) to learn how to use this printable:

<https://www.themeasuredmom.com/free-numbers-book-kids-ages-2-5/>

Thank you for respecting our Terms of Use



The unauthorized reproduction or distribution of a copyrighted work is illegal. Criminal copyright infringement, including infringement without monetary gain, is investigated by the FBI and is punishable by fines and federal imprisonment.

- **YOU MAY** use this file for your own personal, non-commercial use.
- **YOU MAY** print as many copies as you'd like to use in your classroom, home, public library, or tutoring setting.
- **YOU MAY** download this file by visiting <https://www.themeasuredmom.com>.
- **YOU MAY** save this file on your computer.
- **YOU MAY** share the link to the web page where the printable can be found.
- **YOU MAY NOT** link directly to the pdf file. Instead, link to the web page where it can be downloaded.
- **YOU MAY NOT** alter this file or claim this file as your own.
- **YOU MAY NOT** sell or in any way profit from this file. It is also illegal to print this file and sell the printed copy.
- **YOU MAY NOT** use this or any other printable from The Measured Mom on Outschoool.
- **YOU MAY NOT** e-mail this file OR store it on any location where others can download it (Amazon Inspire, Dropbox, Facebook groups and forums, etc.). If you would like to use this file for distance learning, please contact us directly for permission at <https://www.themeasuredmom.com/contact/>.

Credits

Charlotte's Clips



Check out these resources from the shop!

LETTER OF THE WEEK CURRICULUM FOR PRESCHOOL

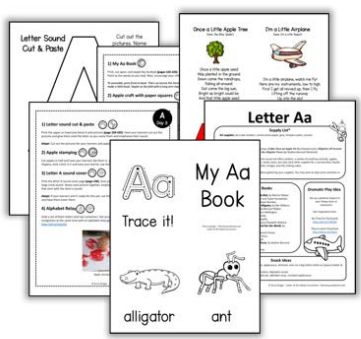
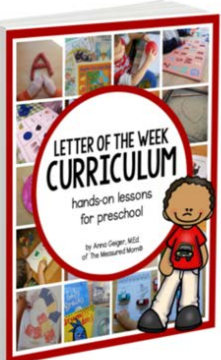

Letter Sound Cut & Paste

Letter Aa

My Aa Book

Trace it!

alligator ant

Preschool Math Curriculum

the measured mom

SIMPLE ACTIVITIES FOR HOME

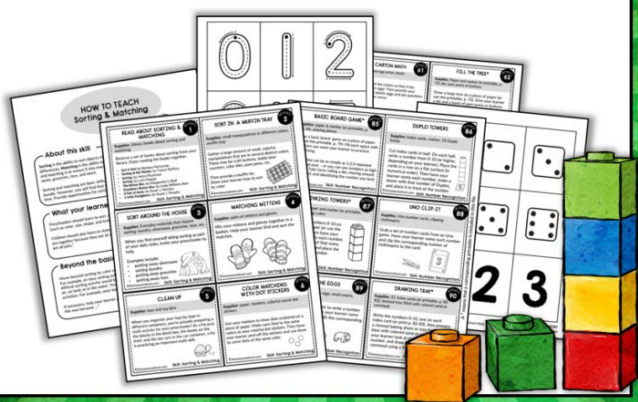

HOW TO TEACH Sorting & Matching

READ ABOUT SORTING & MATCHING

SORT IN A MATHS WAY

BASE TEN GAME

DIPLO TOMES

CARTON BOX

TALK THE TALK

WHAT ABOUT THE HOUSE?

MATCHING MATHS

MATHS TOWER

MATHS CLIP-IT

CLEAN UP

COLOR SPICES WITHOUT TASTING

NEW EGGS

DRAWING TAP

NURSERY RHYME PACK

CONCEPTS OF PRINT FOR PRE-K & K

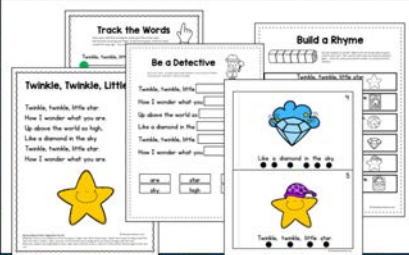

Track the Words

Be a Detective

Build a Rhyme

Twinkle, Twinkle, Little Star

Like a diamond in the sky

A-Z LETTER & PHOTO CARDS

WITH REAL PHOTOS



Bb

Qq Rr

Ss Tt

Mm

Uu

Vv

books turtle mittens

ALPHABET GAMES & ACTIVITIES

INCLUDES EDITABLE GAMES

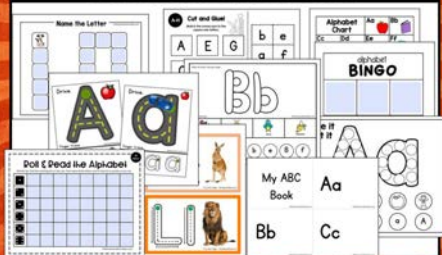

Name the Letter

Cut and Paste

Alphabet Chart

BINGO

My ABC Book

Aa Bb Cc

Find me here

Blog: <https://www.themeasuredmom.com/>

Membership: <https://membership.themeasuredmom.com/>

Podcast: <https://www.themeasuredmom.com/triplerteachingpodcast/>

Teaching Every Reader course: <https://www.teachingeveryreader.com/>

Teaching Every Writer course: <https://www.teachingeverywriter.com/>

Facebook: <https://www.facebook.com/themeasuredmom/>

Pinterest: <https://www.pinterest.com/themeasuredmom/>

Instagram: <https://www.instagram.com/themeasuredmom/>

Contact: <https://www.themeasuredmom.com/contact/>

Printing trouble?

If the file is printing strangely (usually with extra black boxes), please download the free Adobe Reader to your computer. Open and print using that program. 99% of the time, this solves it!

You can get it here: <https://get.adobe.com/reader/>



You're invited to join The Measured Mom Plus!

- our membership site for Pre-K to 3rd grade educators -



- ✓ **Save hours of time** with our one-click printable library. You'll find hundreds of math and literacy resources for Pre-K through third grade.
- ✓ Get **free no-print resources** that are perfect for at-home use and distance learning.
- ✓ Recharge your teaching with on-demand **video workshops and mini-courses** that you can watch 24/7.
- ✓ **Save 33% on all products from The Measured Mom Shop.**

[LEARN MORE](#)





I Can Count
Things That Go

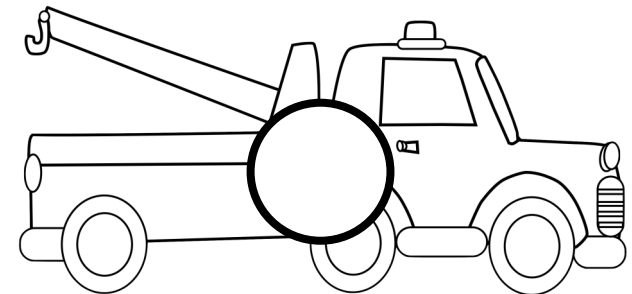
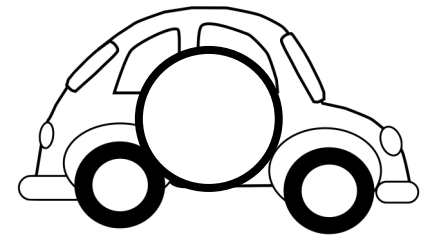
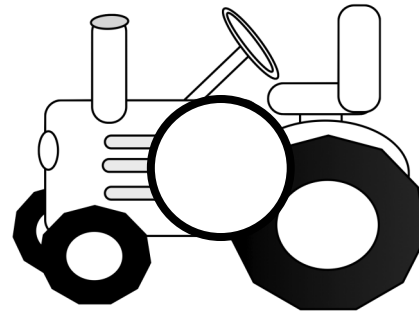
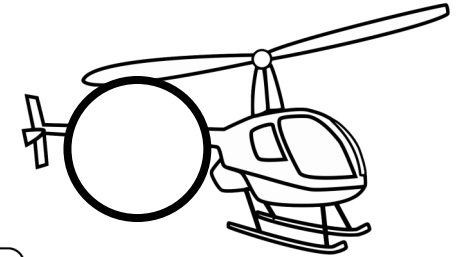
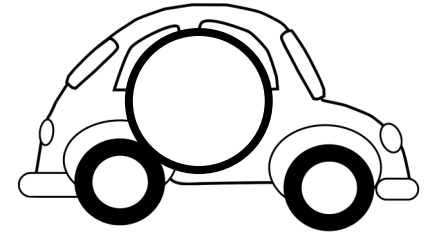
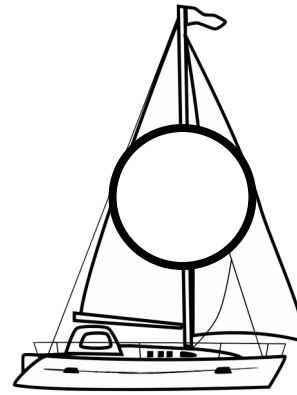
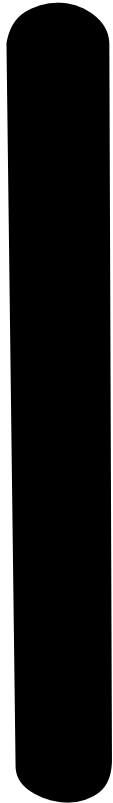

10 things that go.

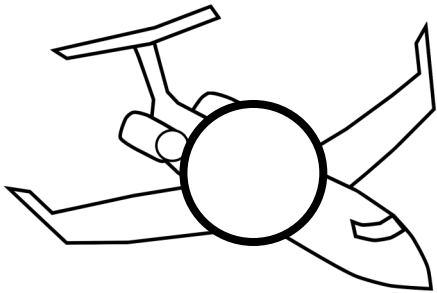
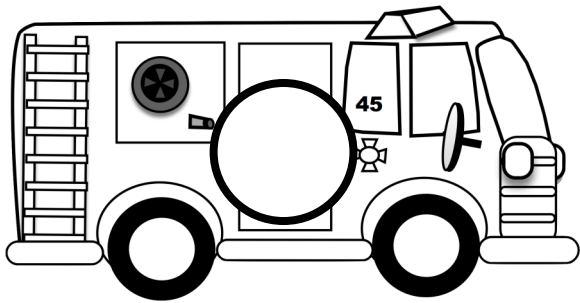
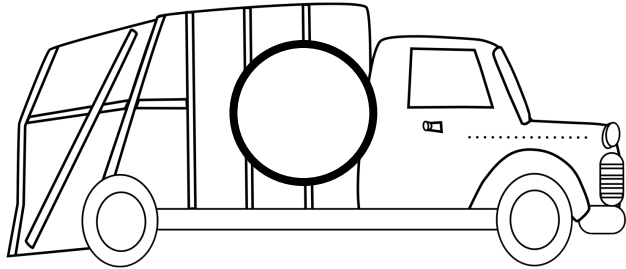
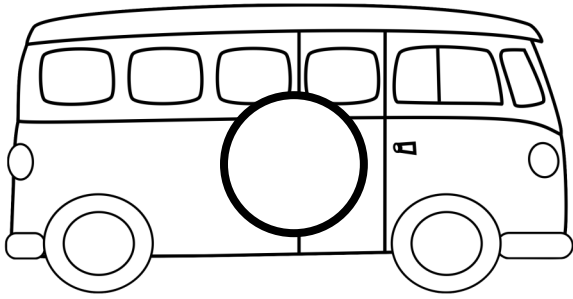

I can count

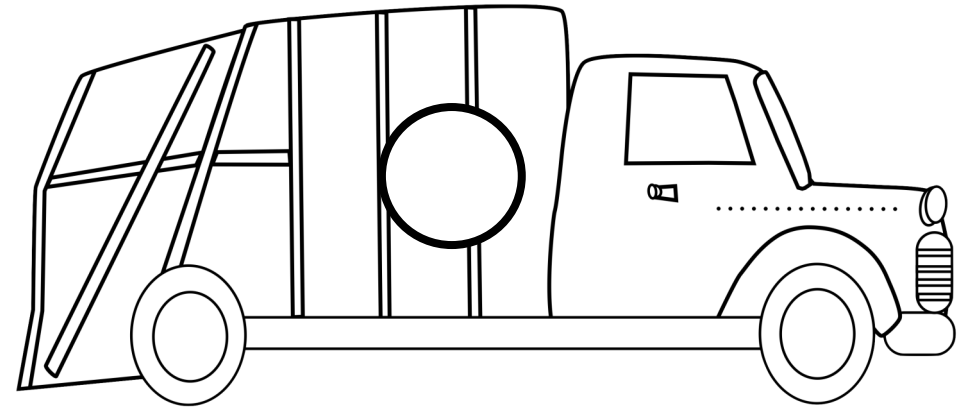

I garbage truck

2

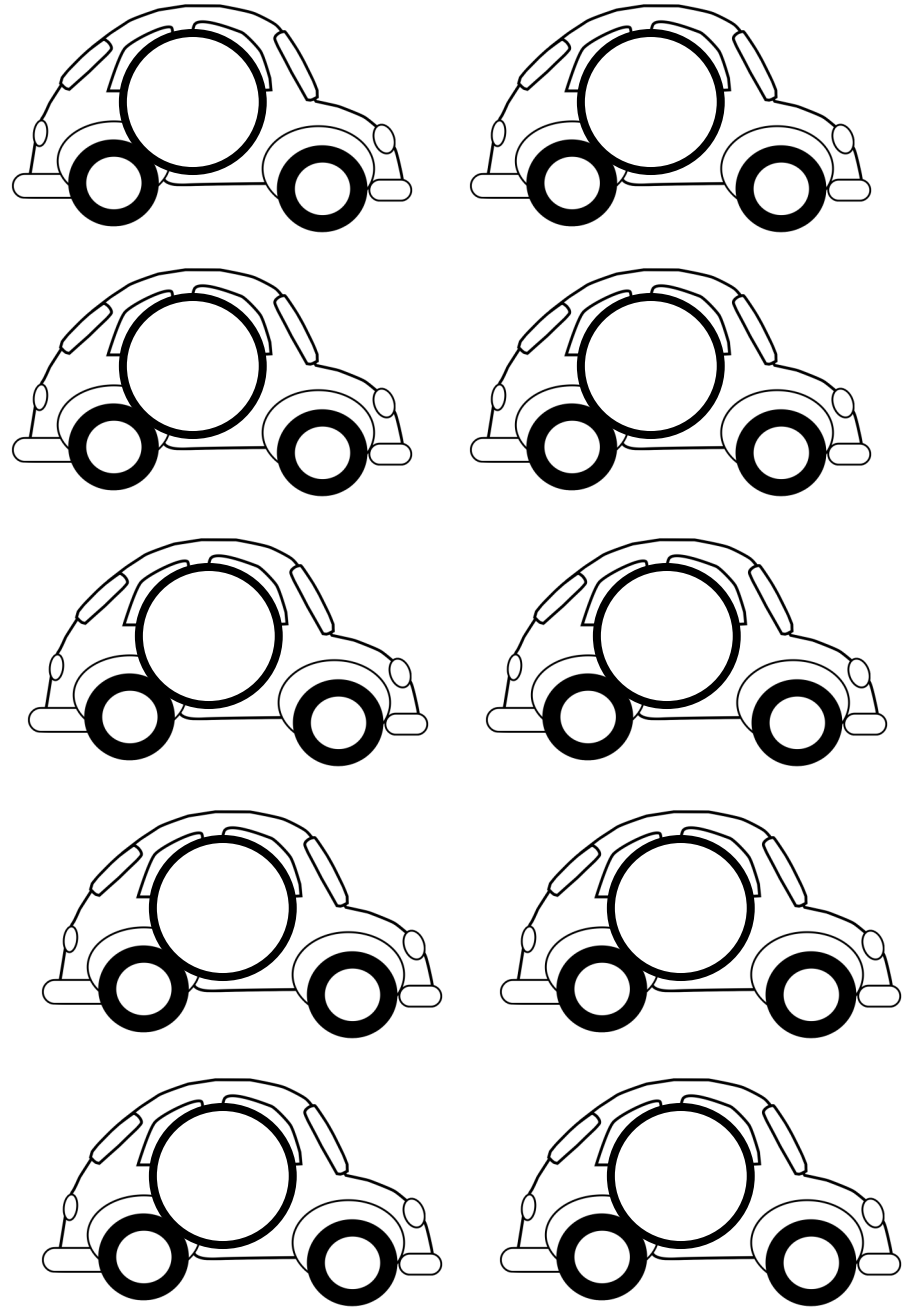

10 cars

10

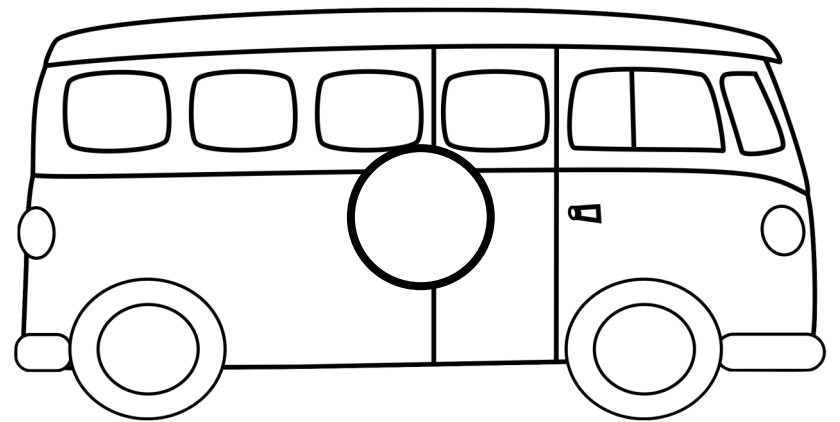
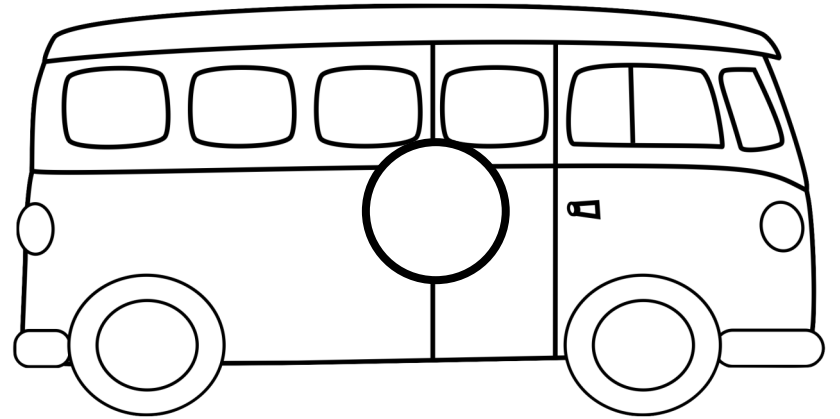

2 vans

3

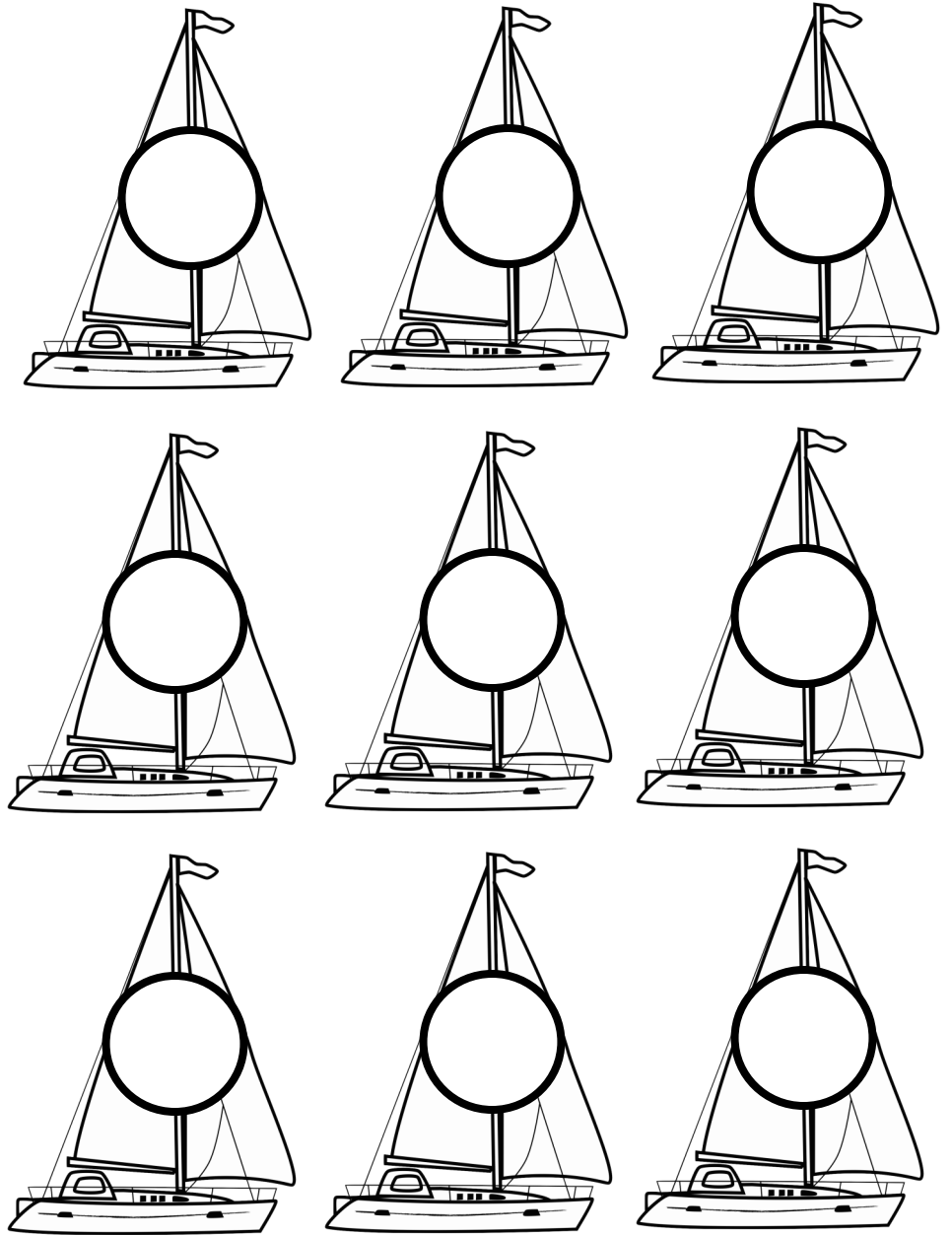

9 sail boats

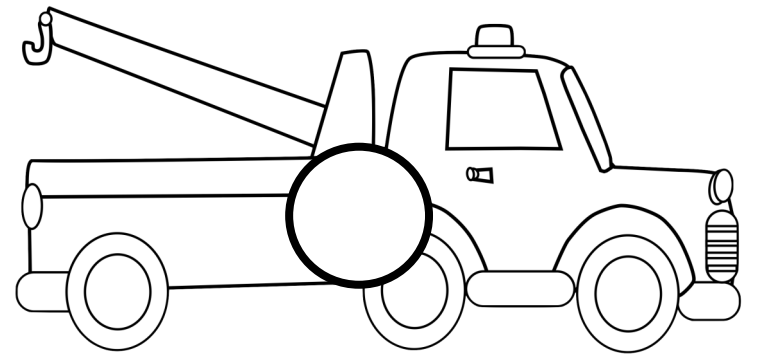
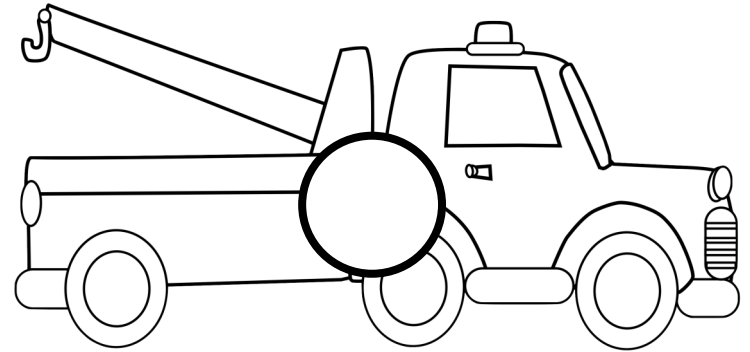
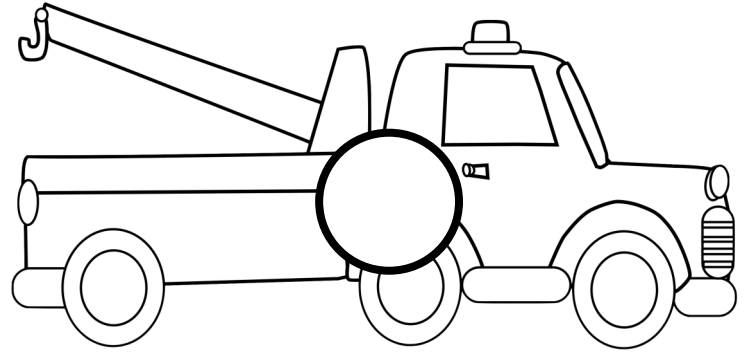
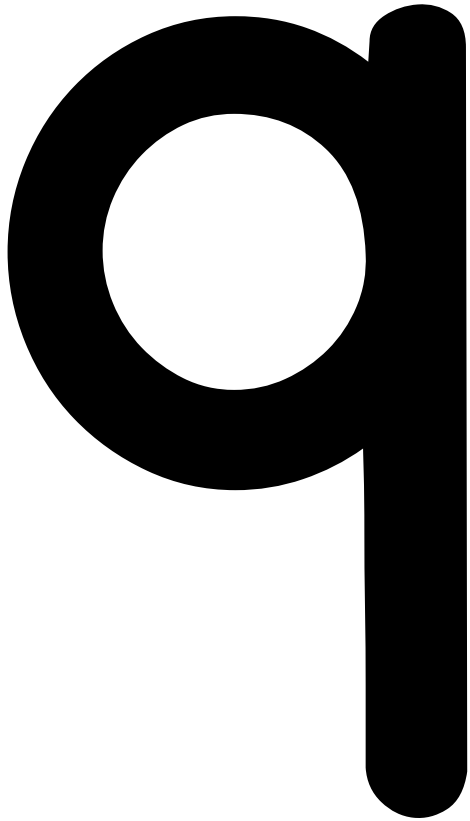

3 tow trucks

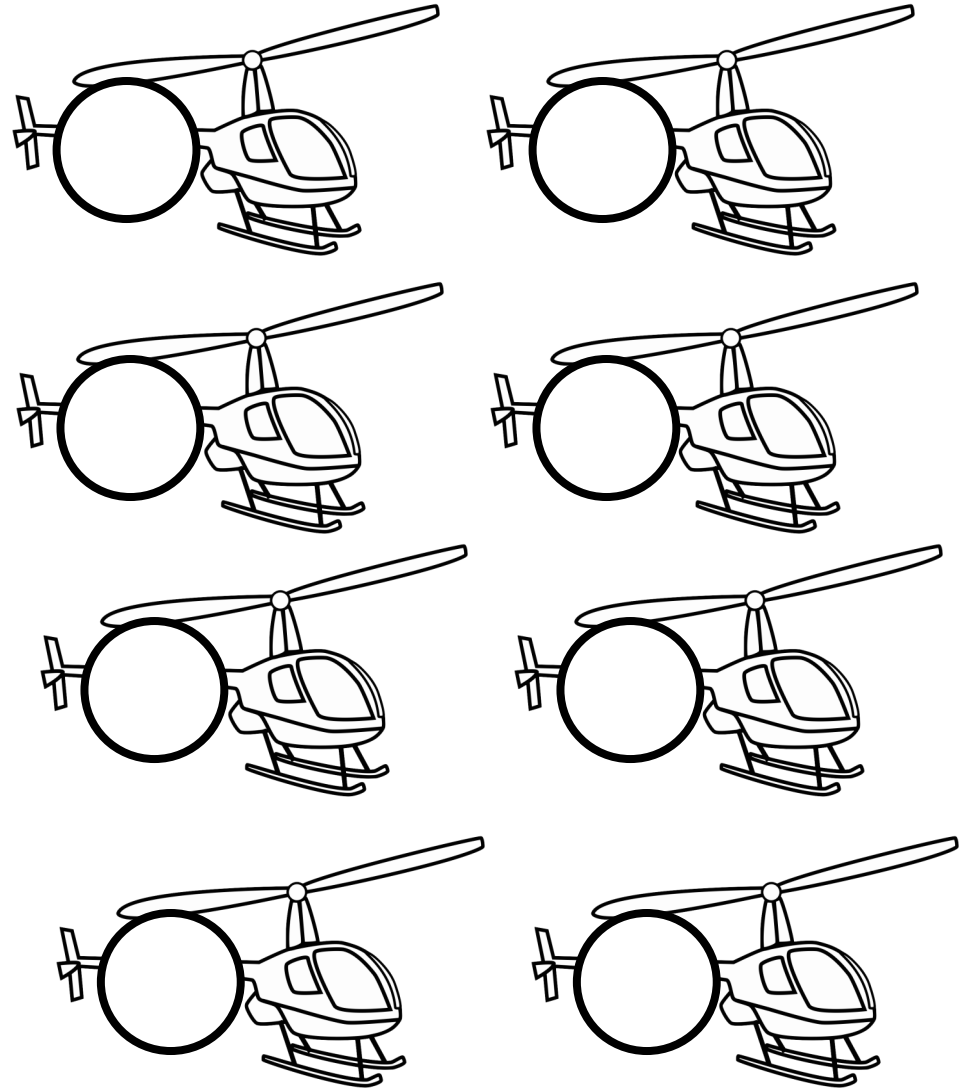
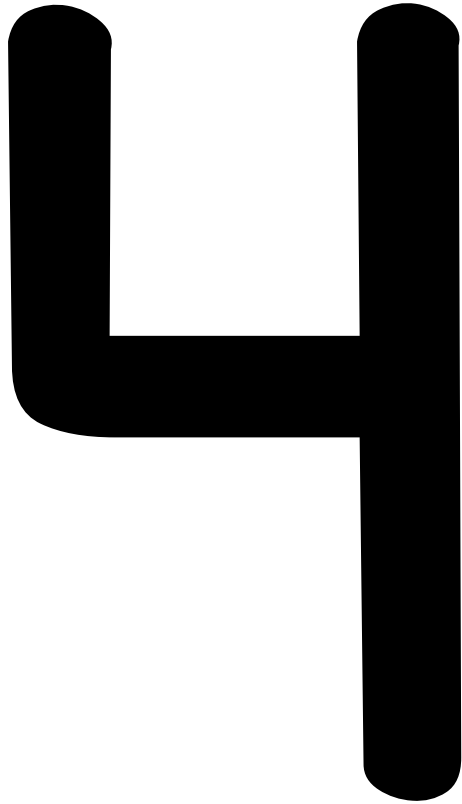

8 helicopters

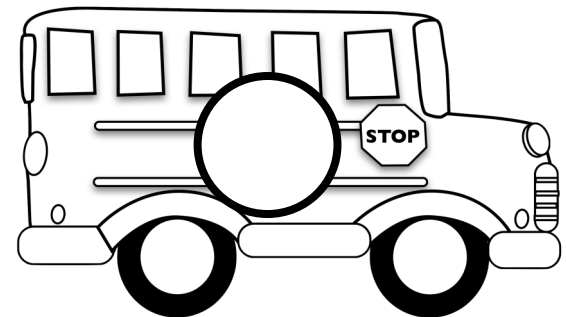
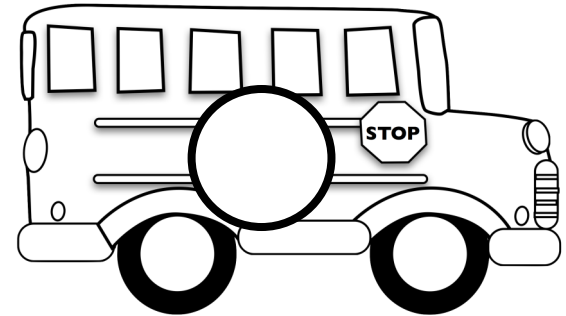
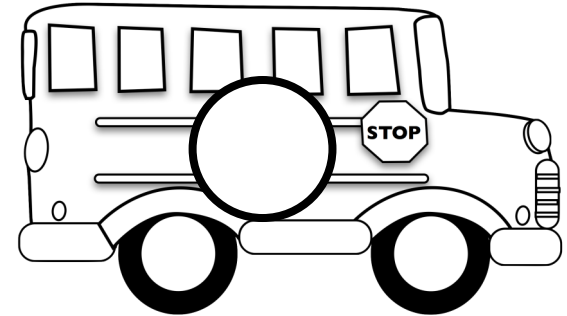
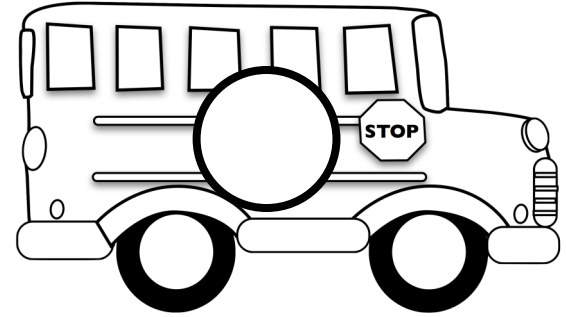
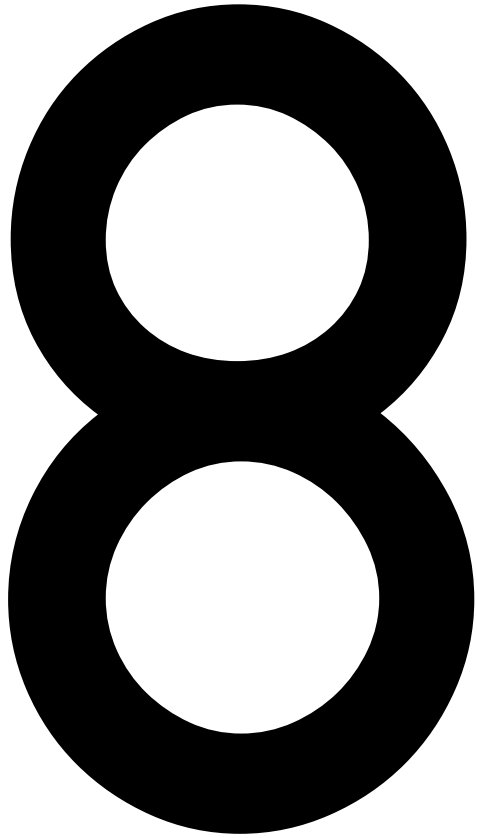

4 school buses

5

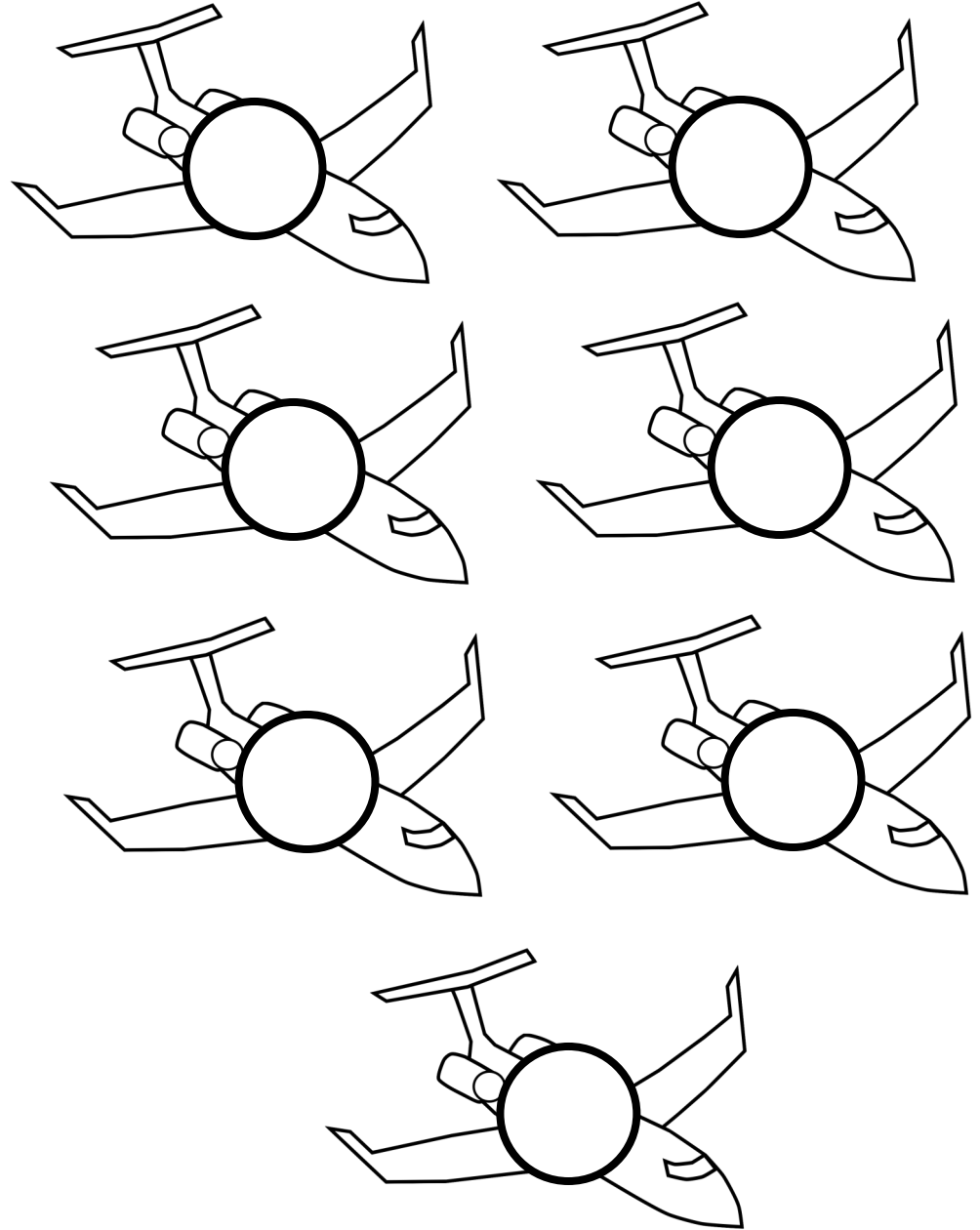

7 airplanes

7

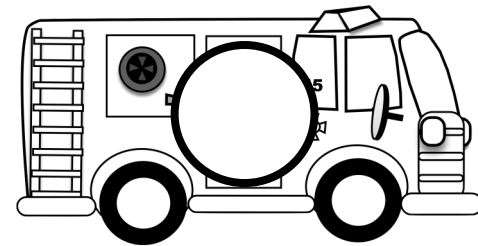
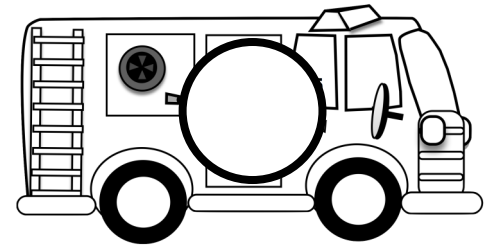
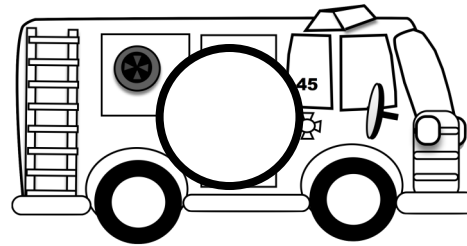
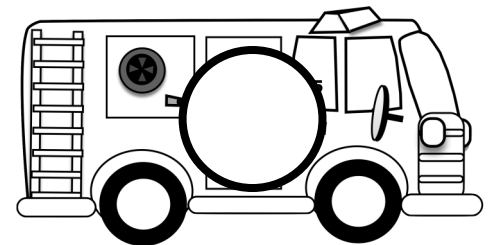
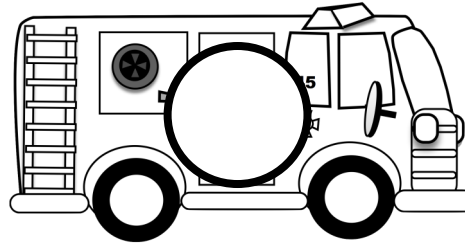

5 fire trucks

6

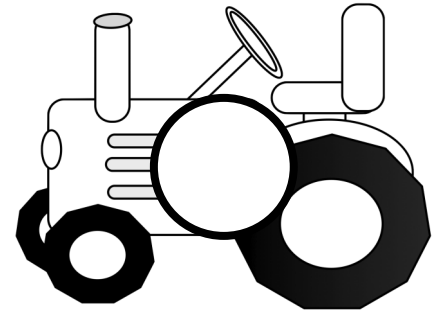
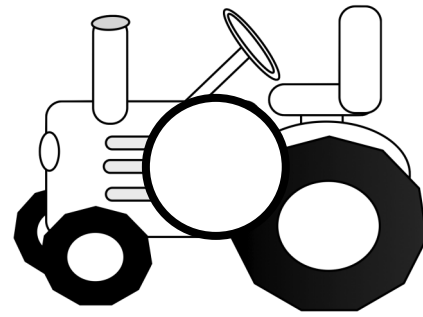
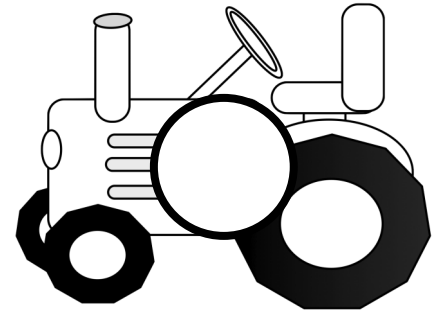
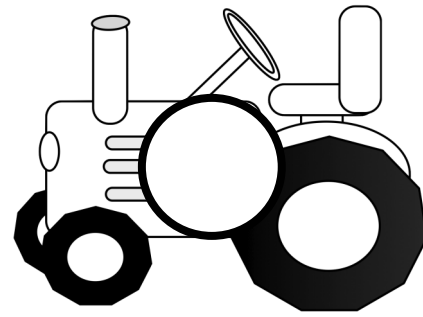
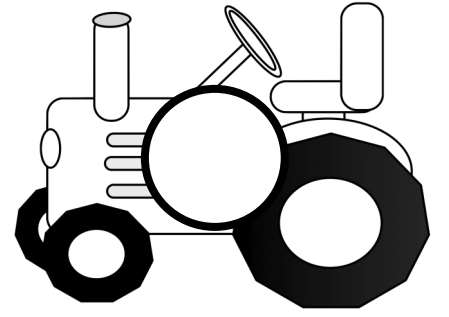
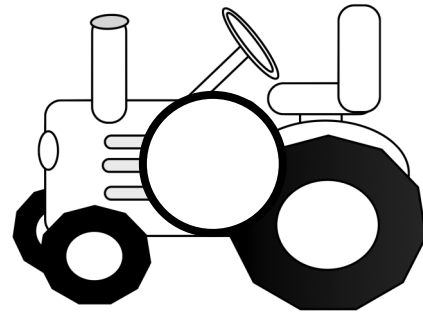

6 tractors