

Find the Letter Alphabet Worksheets

Please visit [themeasuredmom.com](https://www.themeasuredmom.com) to learn how to use this printable:

<https://www.themeasuredmom.com/free-find-the-letter-alphabet-worksheets/>

Thank you for respecting our Terms of Use



The unauthorized reproduction or distribution of a copyrighted work is illegal. Criminal copyright infringement, including infringement without monetary gain, is investigated by the FBI and is punishable by fines and federal imprisonment.

- **YOU MAY** use this file for your own personal, non-commercial use.
- **YOU MAY** print as many copies as you'd like to use in your classroom, home, public library, or tutoring setting.
- **YOU MAY** download this file by visiting <https://www.themeasuredmom.com>.
- **YOU MAY** save this file on your computer.
- **YOU MAY** share the link to the web page where the printable can be found.
- **YOU MAY NOT** link directly to the pdf file. Instead, link to the web page where it can be downloaded.
- **YOU MAY NOT** alter this file or claim this file as your own.
- **YOU MAY NOT** sell or in any way profit from this file. It is also illegal to print this file and sell the printed copy.
- **YOU MAY NOT** use this or any other printable from The Measured Mom on Outschoool.
- **YOU MAY NOT** e-mail this file OR store it on any location where others can download it (Amazon Inspire, Dropbox, Facebook groups and forums, etc.). If you would like to use this file for distance learning, please contact us directly for permission at <https://www.themeasuredmom.com/contact/>.

Clip art via Whimsy Workshop Teaching

To print just the uppercase pages, print pages 5-30.

To print just the lowercase pages, print pages 31-56.

To print the upper/lowercase combined pages, print pages 57-82.



Check out these resources from the shop!

Short Vowel

WORD FAMILY MATS & GAMES



After you do the word family mat activity, a line from each picture to its name.

Roll & Read (ap)

Read & Race (ap)

cap

the measured mom

SHORT VOWEL

WORD SLIDER CARDS

CVC, CCVC, CVCC & CCVCC WORDS



men

den

ten

band

sand

hand

clock

knock

the measured mom

EDITABLE

SIGHT WORD GAMES

150 SEASONAL GAMES



FOLLOW THE PATH

TIC-TAC-TOE

SIGHT WORD BUMP

SNAKES & LADDERS

ROLL, READ & COVER

NO-PREP MATH & LITERACY GAMES

120 GAMES STUDENTS CAN PLAY ALONE OR IN PAIRS

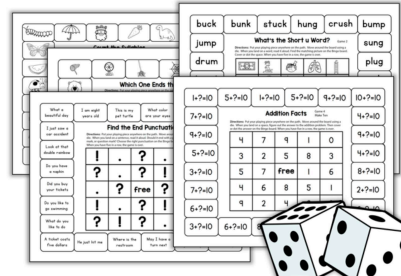

buck, bunk, stuck, hung, crush, bump, jump, drum, plug, sung

What's the Start or Word?

Which One Ends It?

Find the End Paragraph

Free!

the measured mom

HANDWRITING

WORKSHEETS

GIANT BUNDLE OF 330 WORKSHEETS

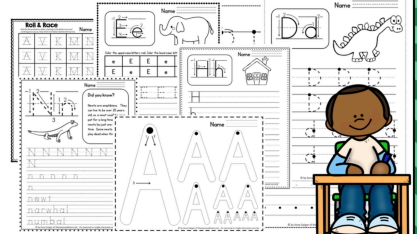

Roll & Race

the measured mom

Find me here

Blog: <https://www.themeasuredmom.com/>

Membership: <https://membership.themeasuredmom.com/>

Podcast: <https://www.themeasuredmom.com/triplerteachingpodcast/>

Teaching Every Reader course: <https://www.teachingeveryreader.com/>

Teaching Every Writer course: <https://www.teachingeverywriter.com/>

Facebook: <https://www.facebook.com/themeasuredmom/>

Pinterest: <https://www.pinterest.com/themeasuredmom/>

Instagram: <https://www.instagram.com/themeasuredmom/>

Contact: <https://www.themeasuredmom.com/contact/>

Printing trouble?

If the file is printing strangely (usually with extra black boxes), please download the free Adobe Reader to your computer. Open and print using that program. 99% of the time, this solves it!

You can get it here: <https://get.adobe.com/reader/>



You're invited to join The Measured Mom Plus!

- our membership site for Pre-K to 3rd grade educators -



- ✓ **Save hours of time** with our one-click printable library. You'll find hundreds of math and literacy resources for Pre-K through third grade.
- ✓ Get **free no-print resources** that are perfect for at-home use and distance learning.
- ✓ Recharge your teaching with on-demand **video workshops and mini-courses** that you can watch 24/7.
- ✓ **Save 33% on all products from The Measured Mom Shop.**

[LEARN MORE](#)



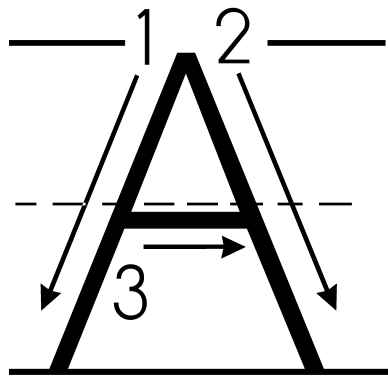

is for
apple

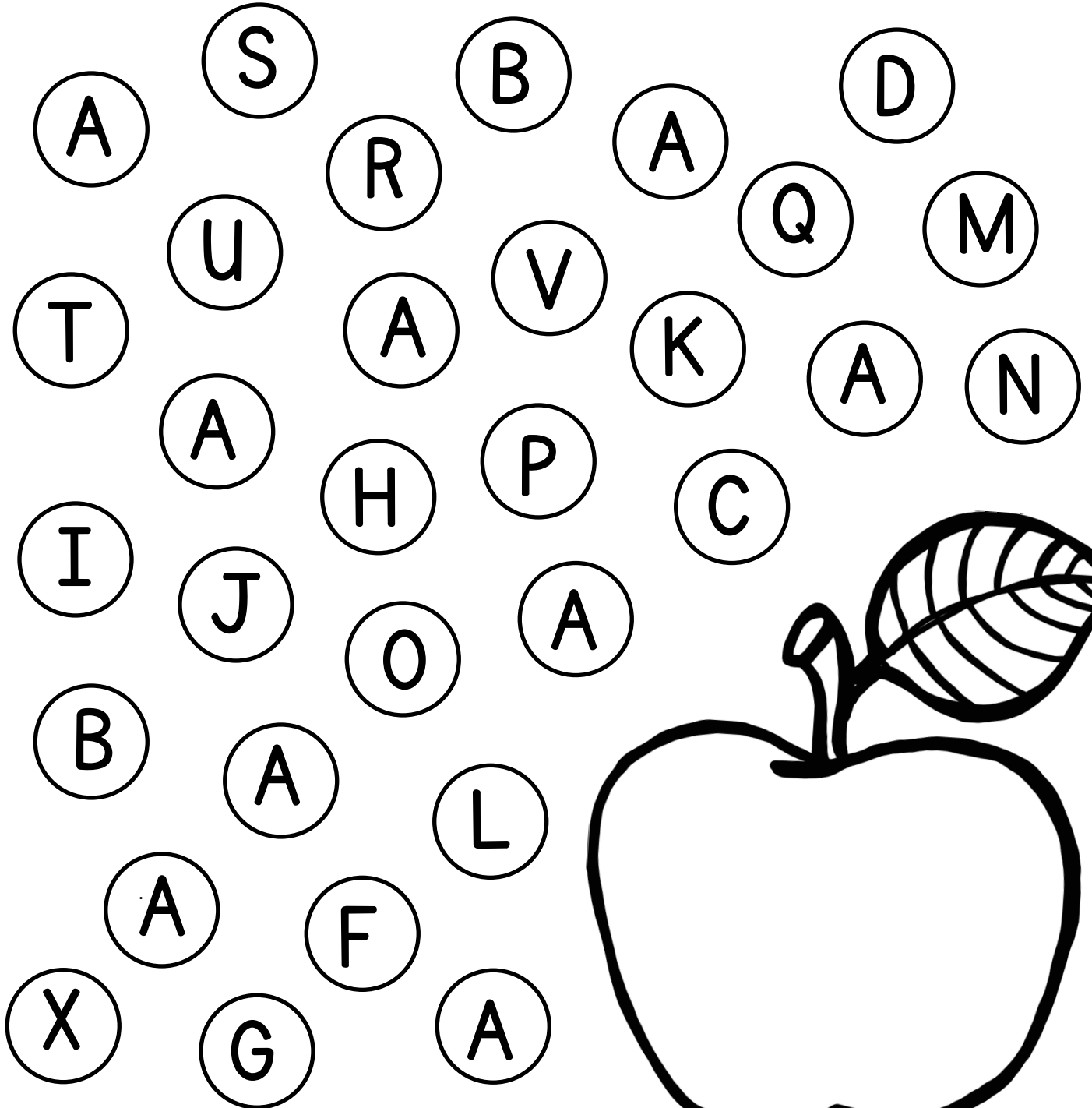

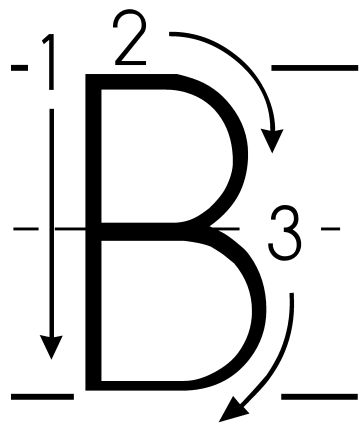

is for
bird

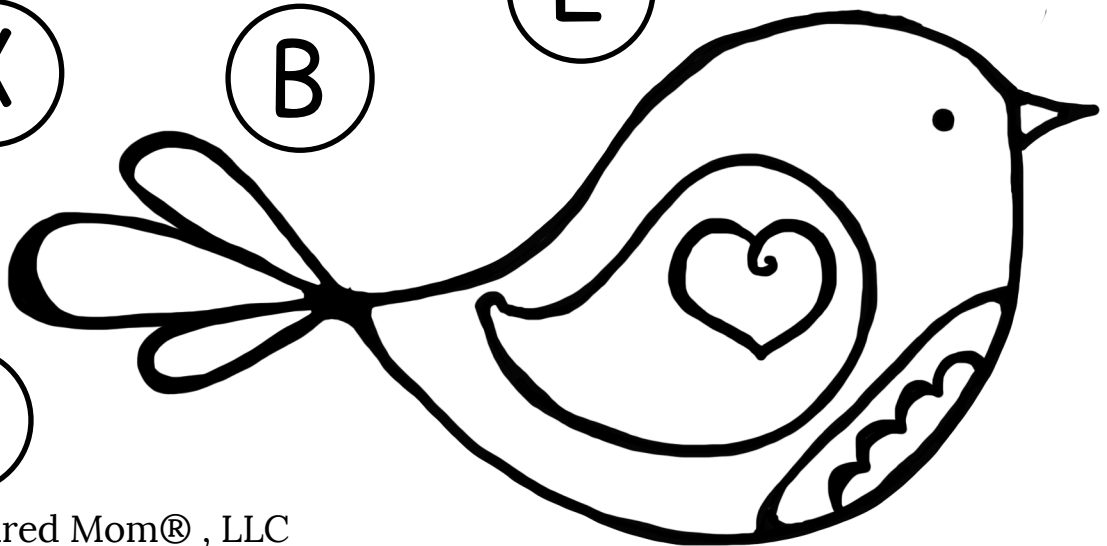
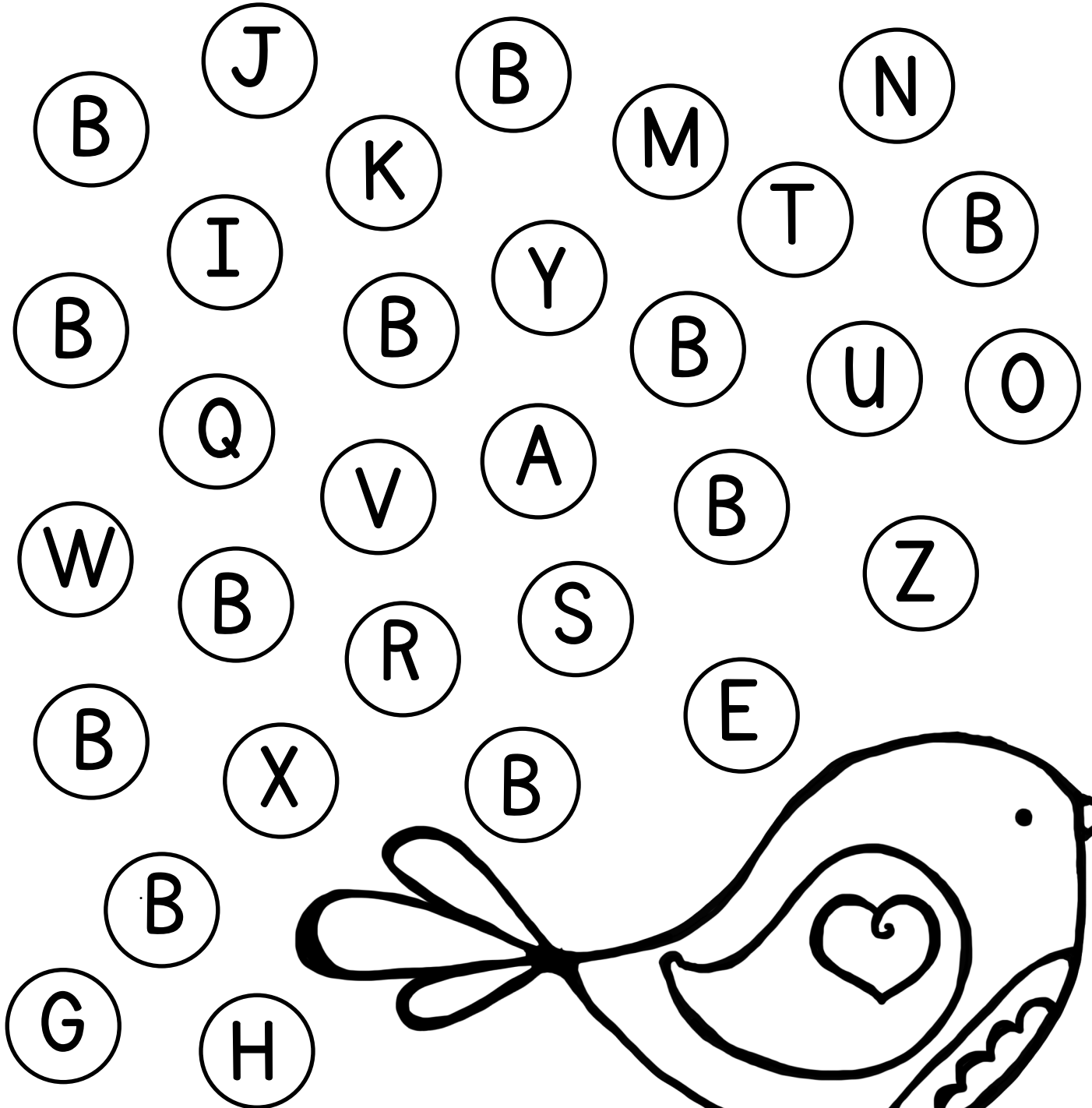

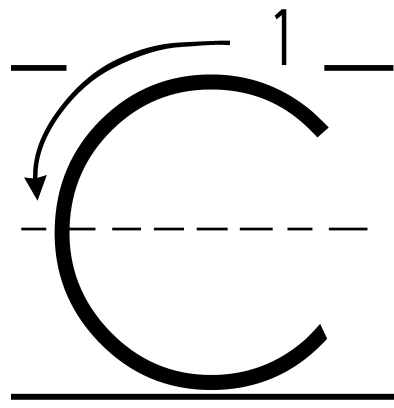

is for
cat

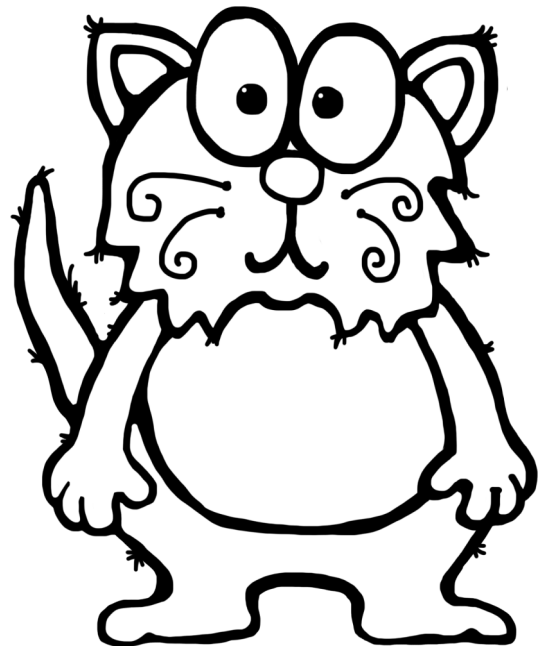
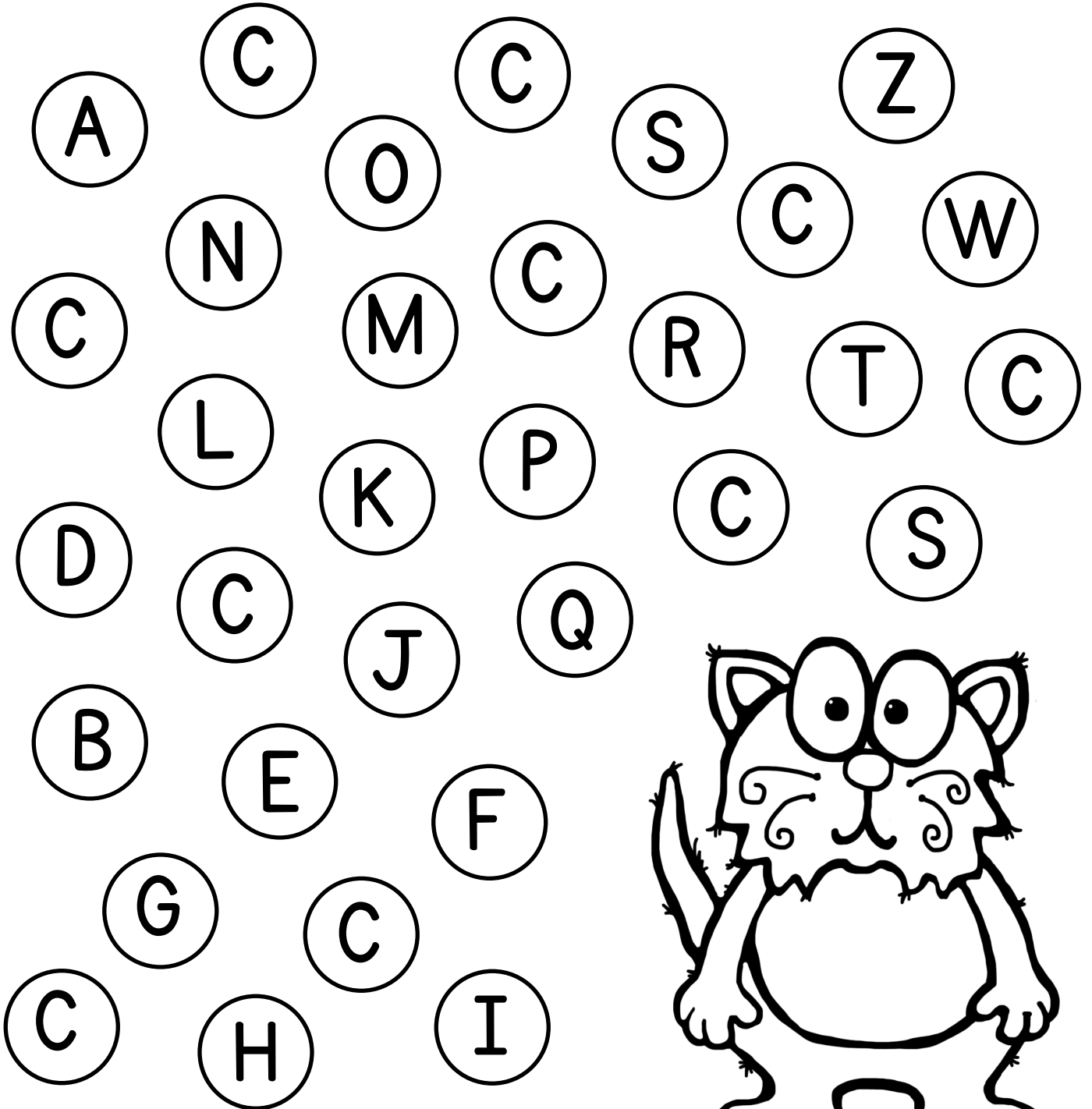

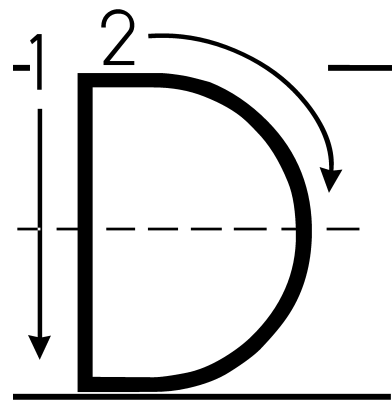

D is for
dinosaur

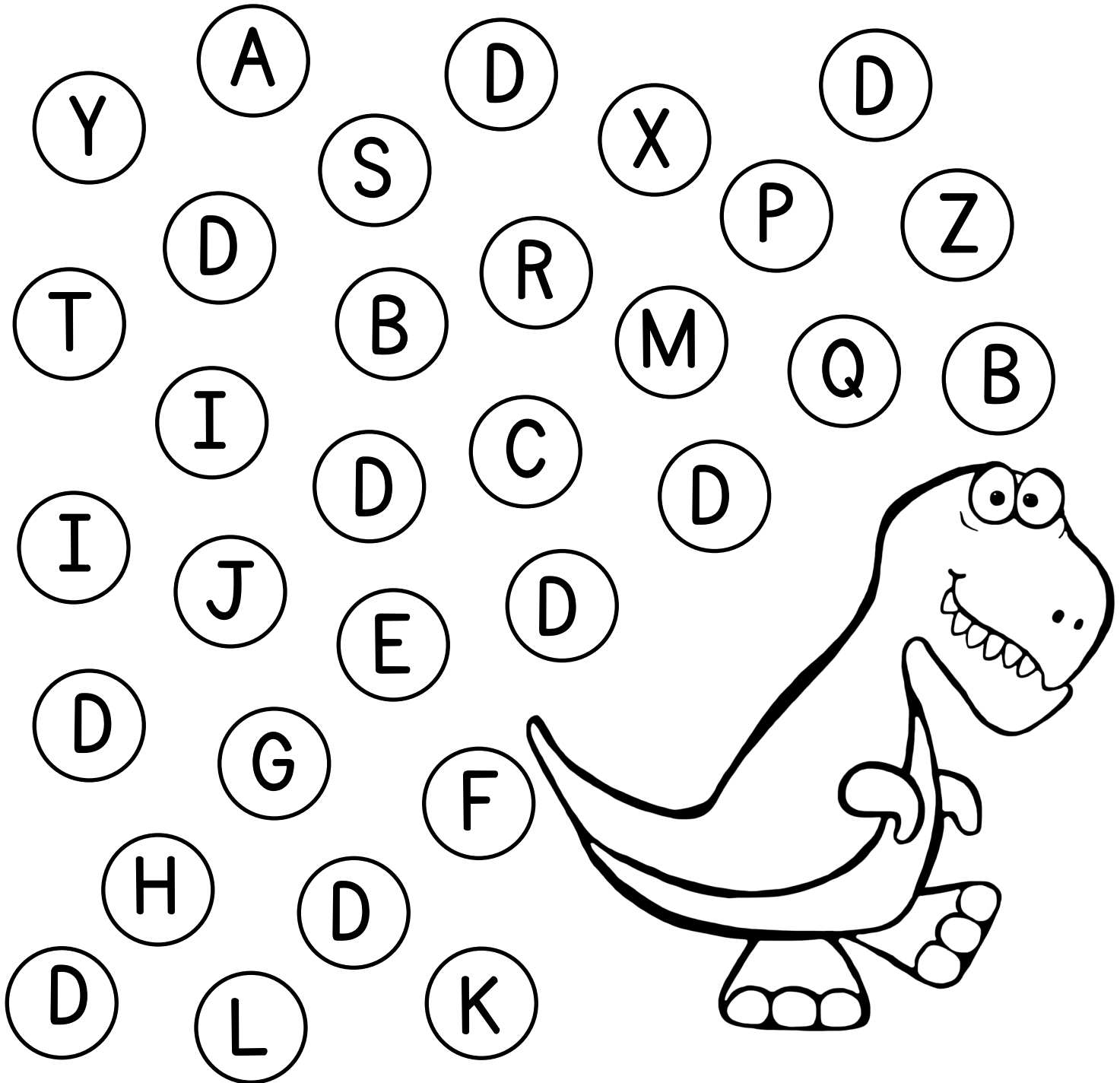

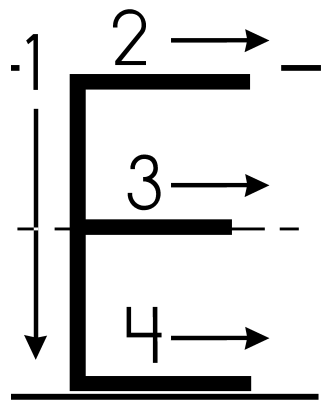

is for
elephant

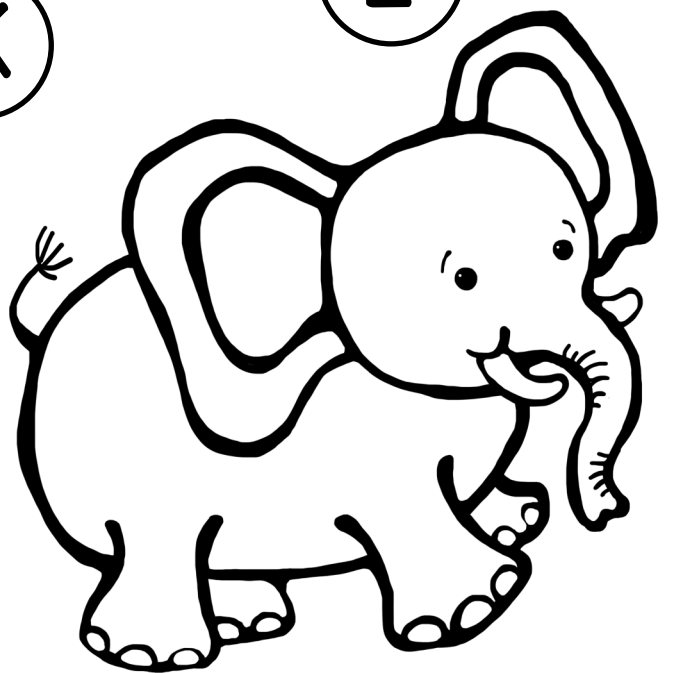
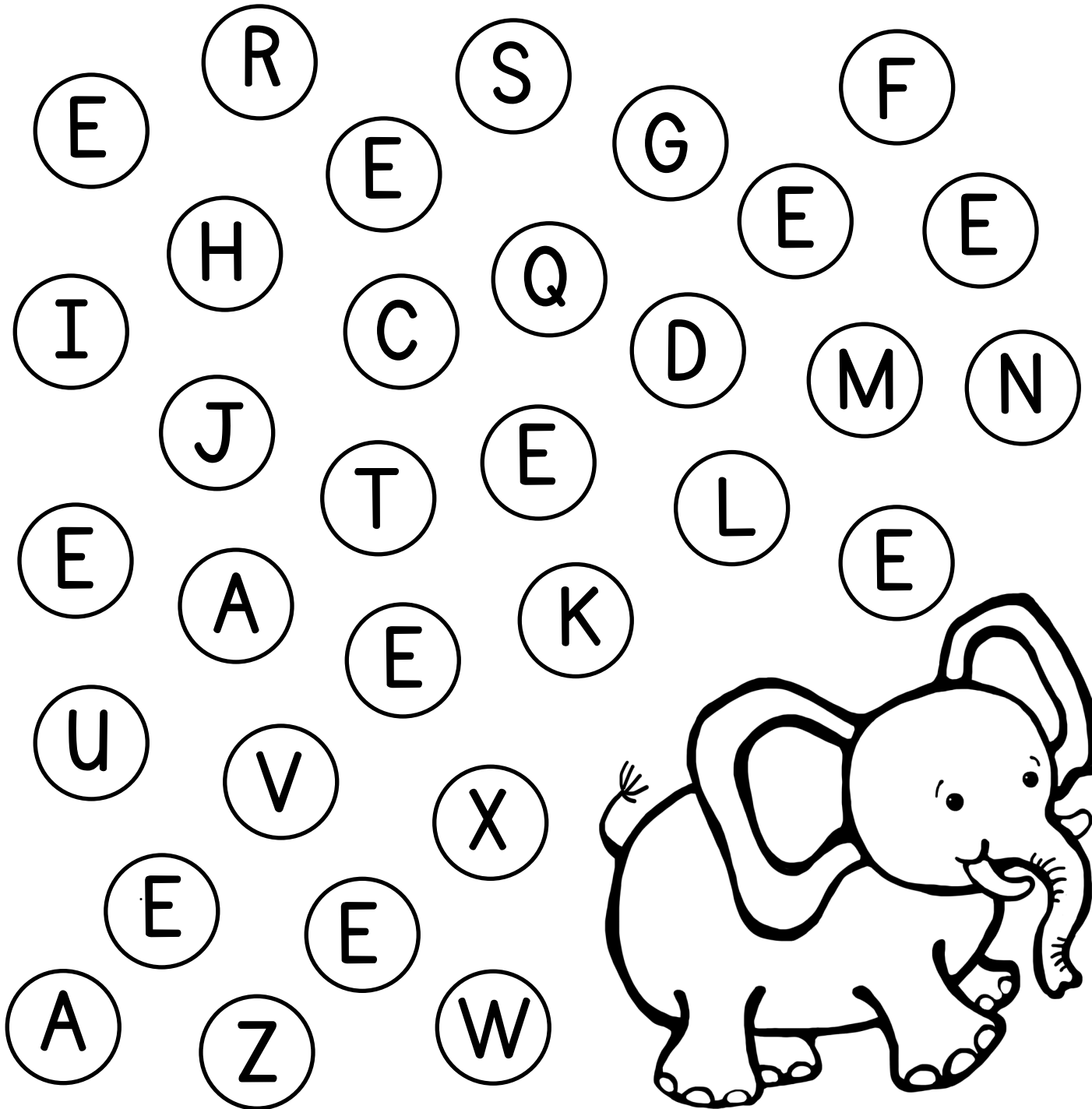

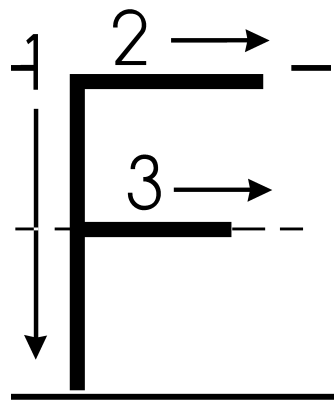

is for
frog

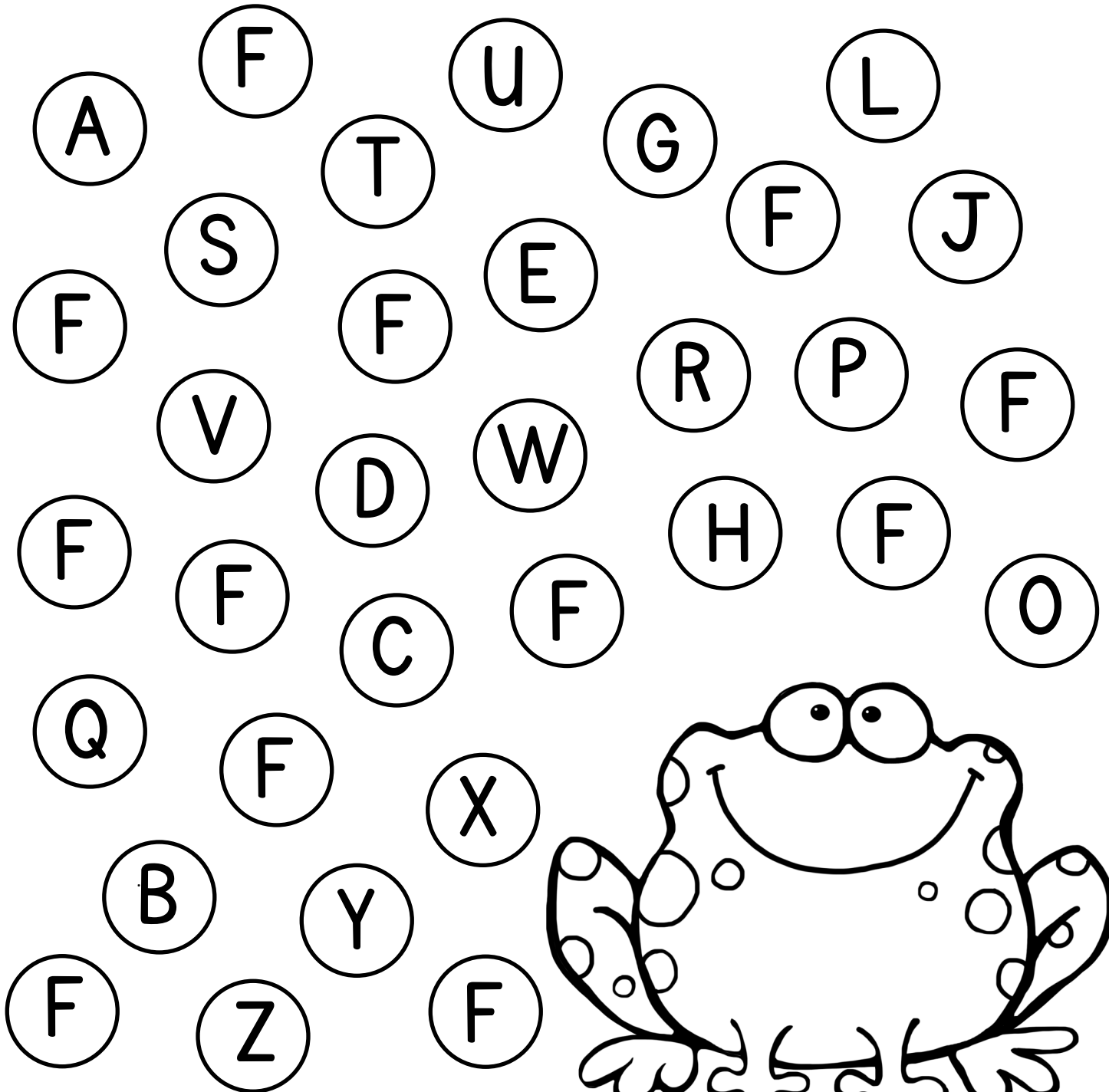

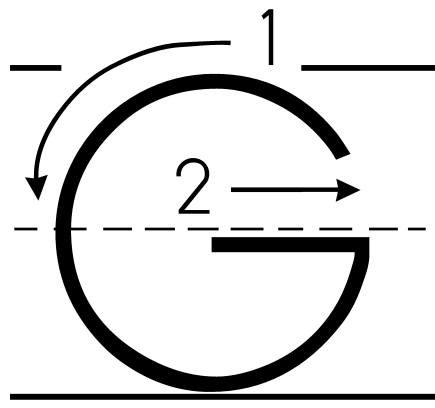

is for
gumballs

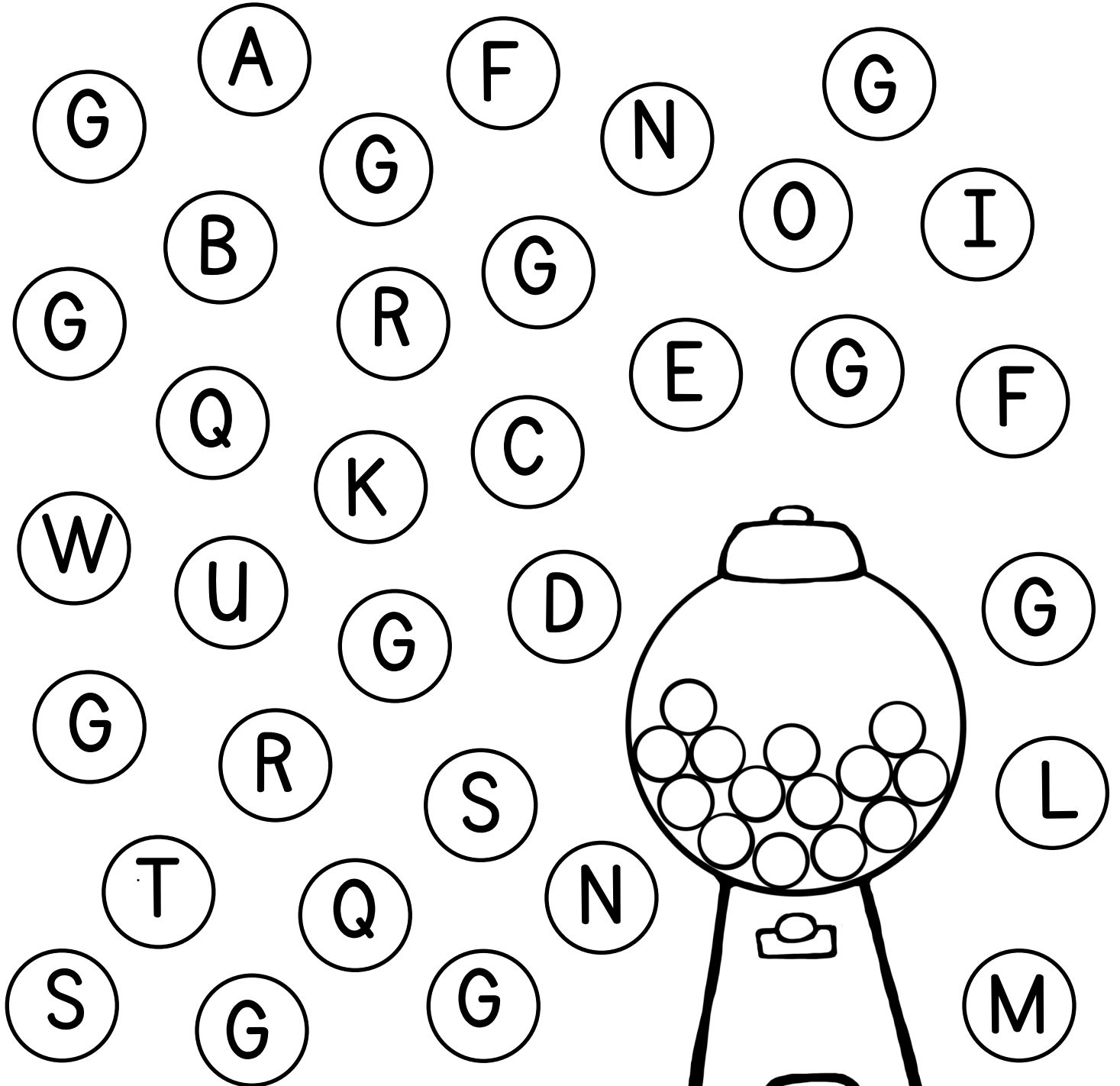

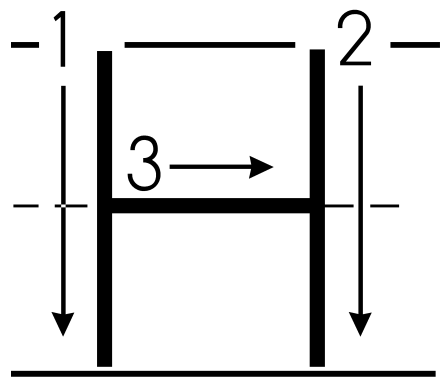

is for
hippo

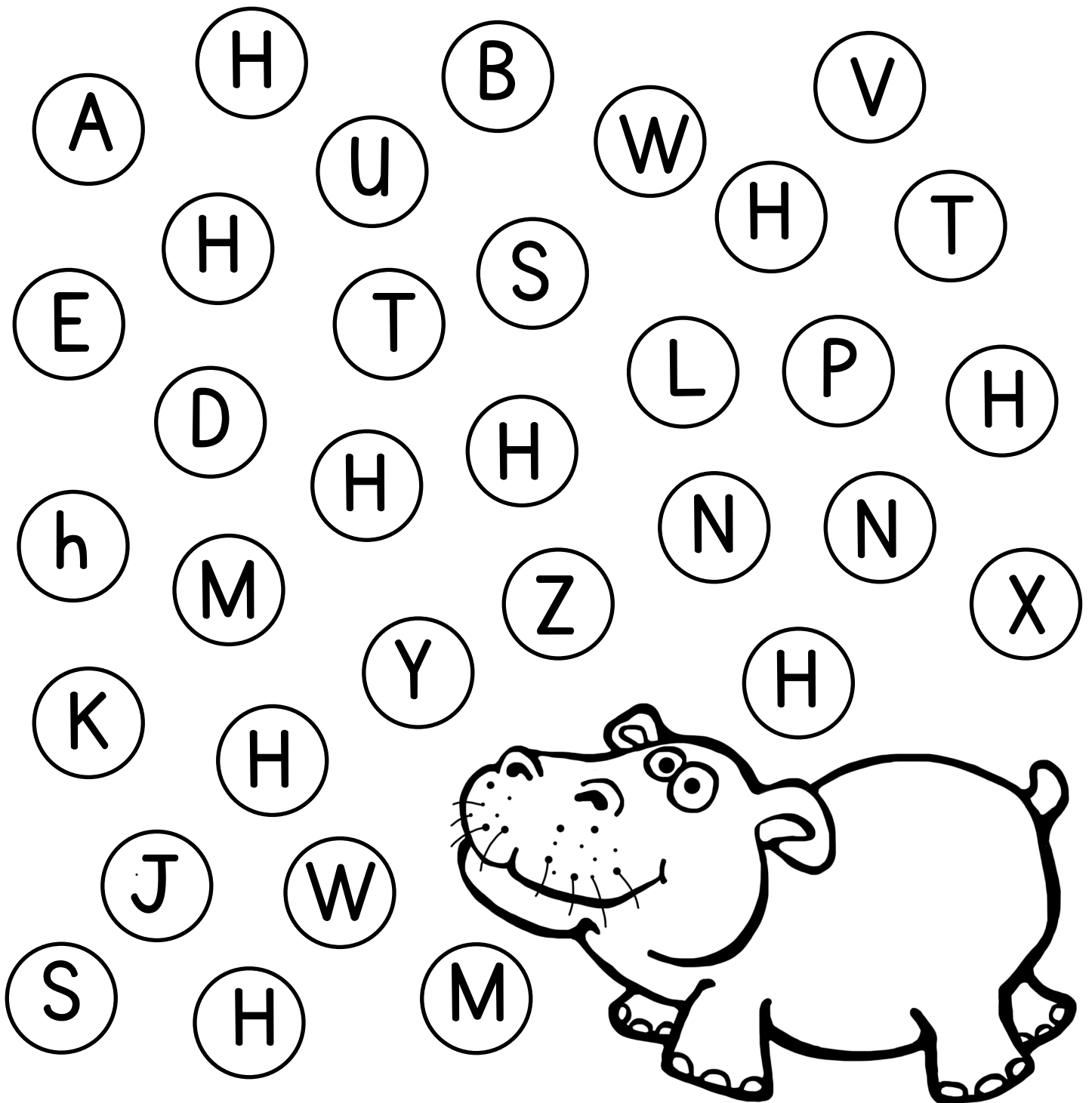

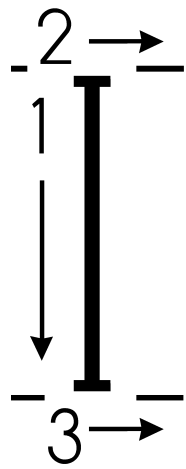

is for
igloo

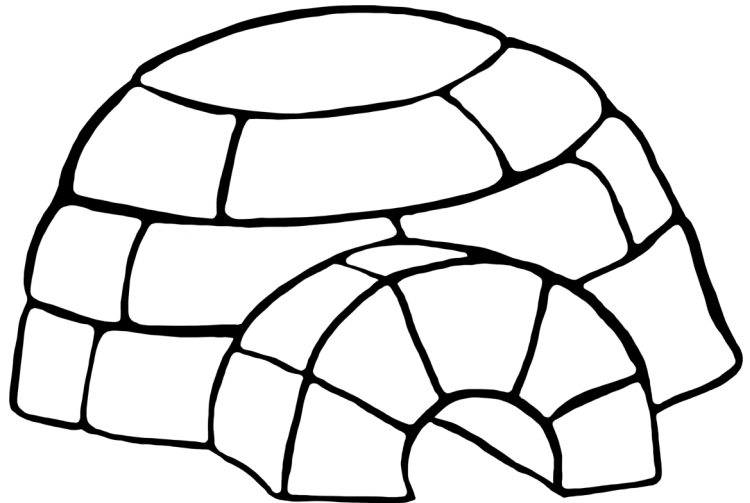
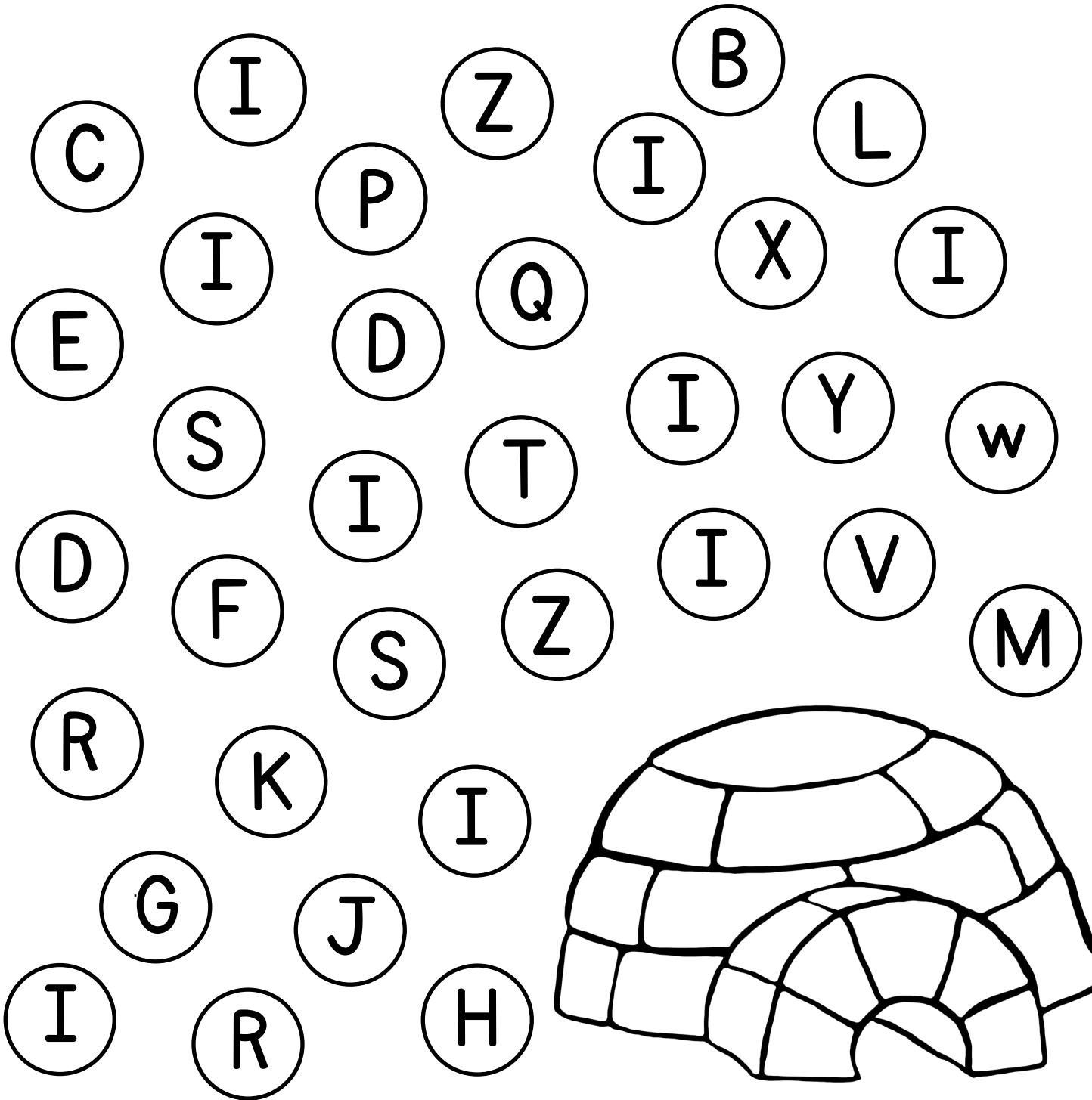

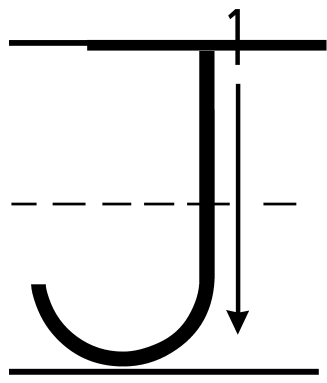

is for
jellyfish

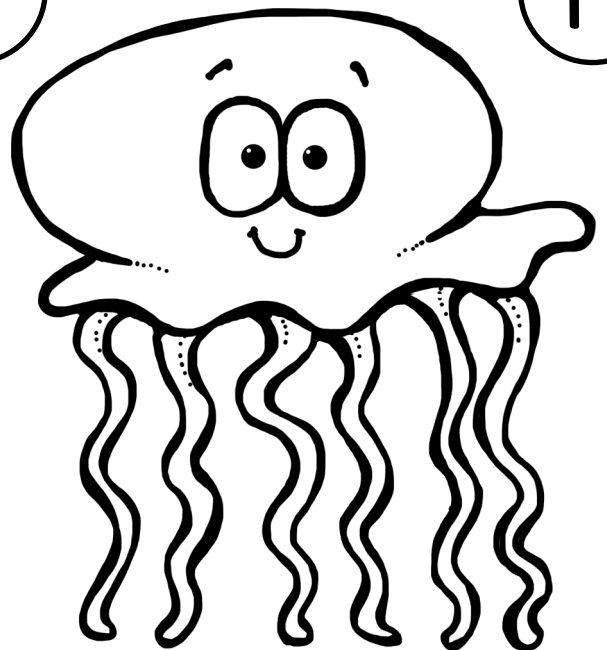
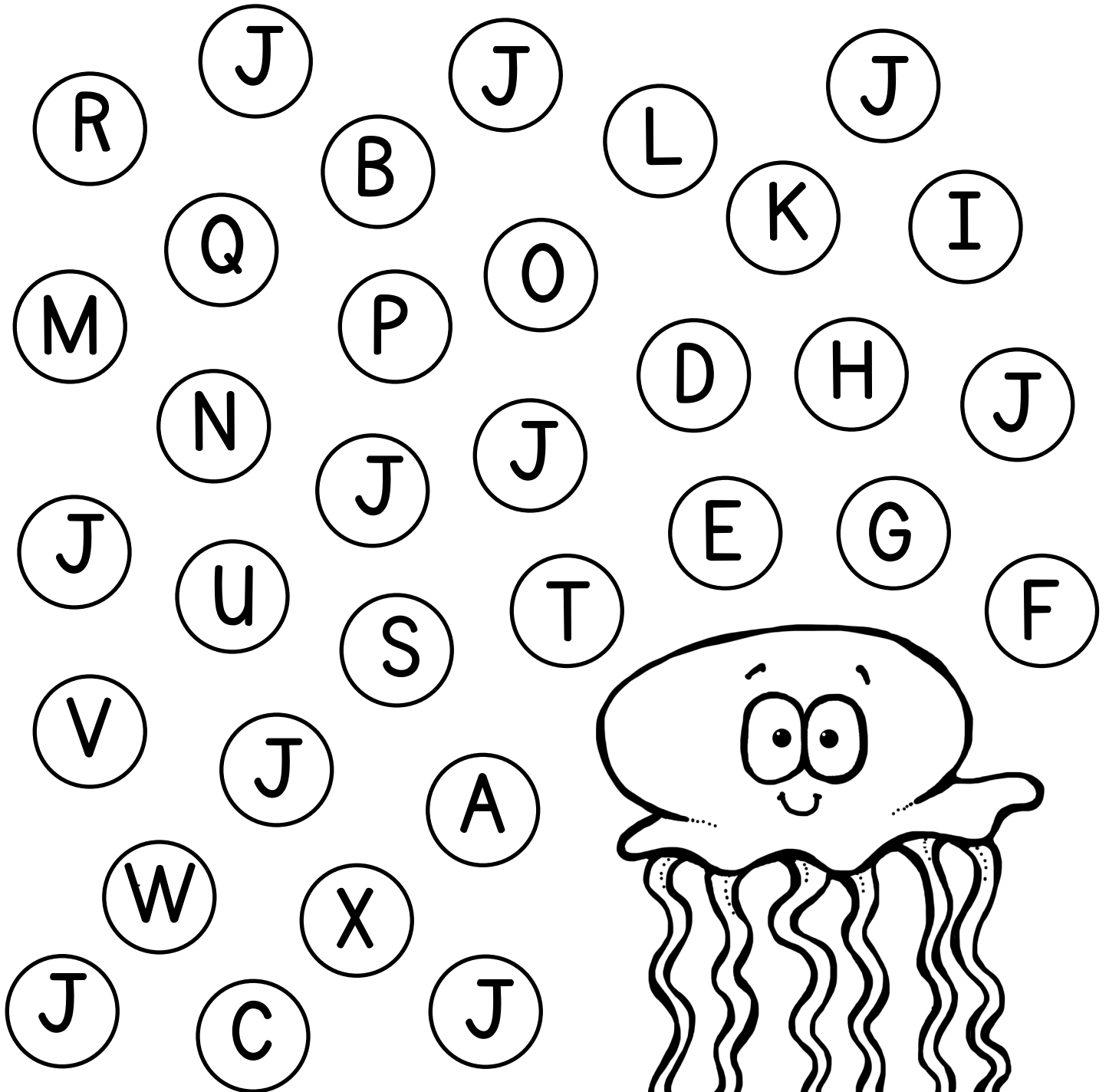

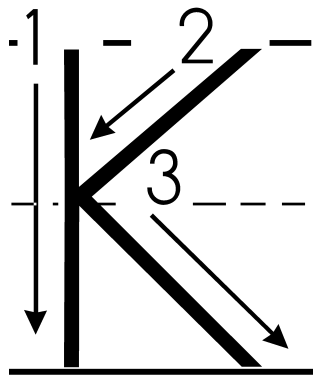

is for
koala

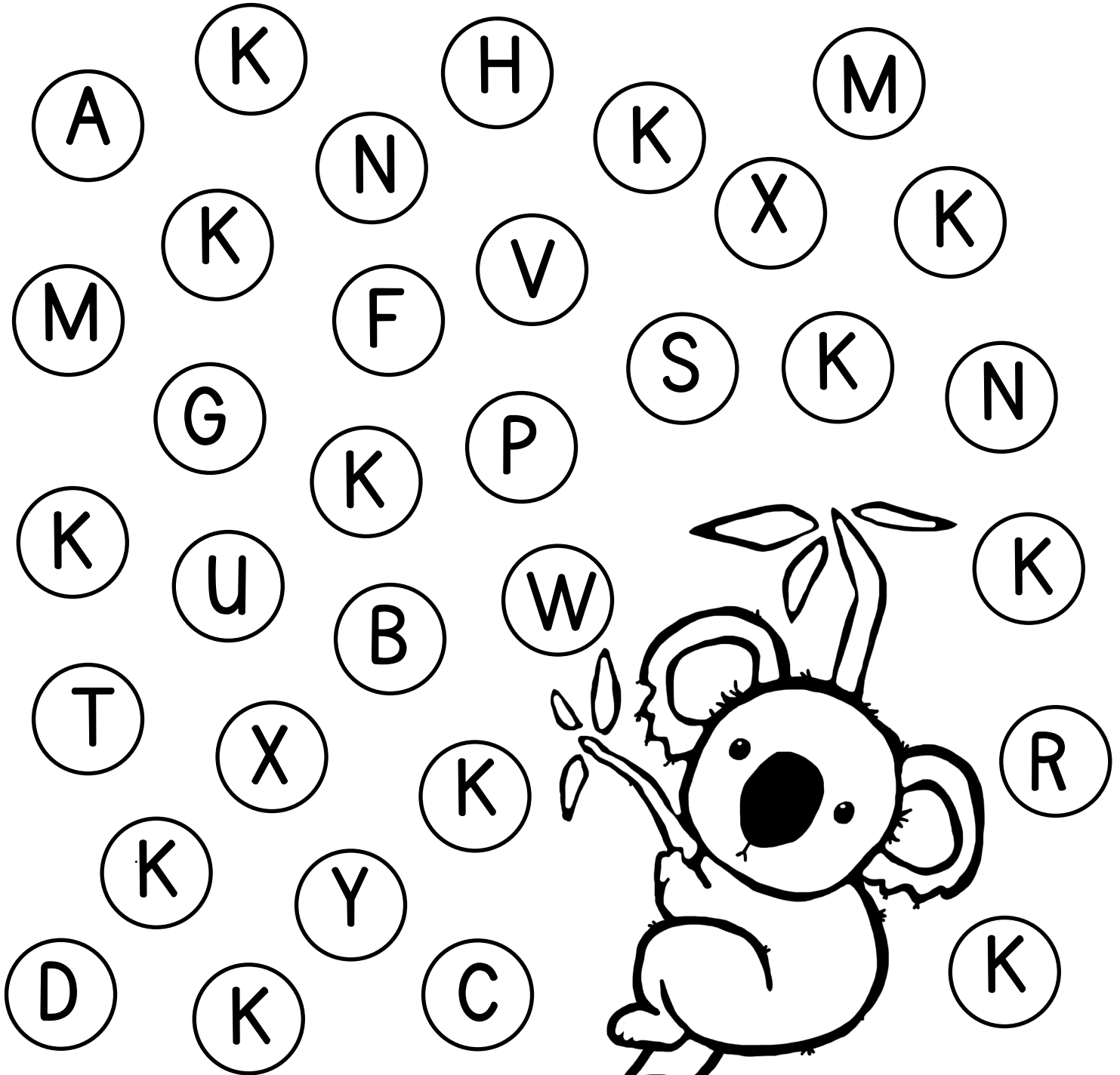

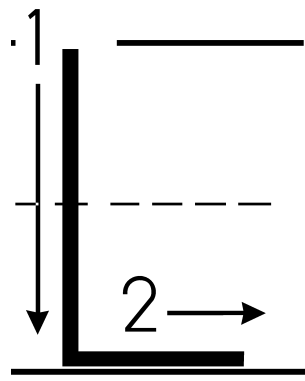

is for
lion

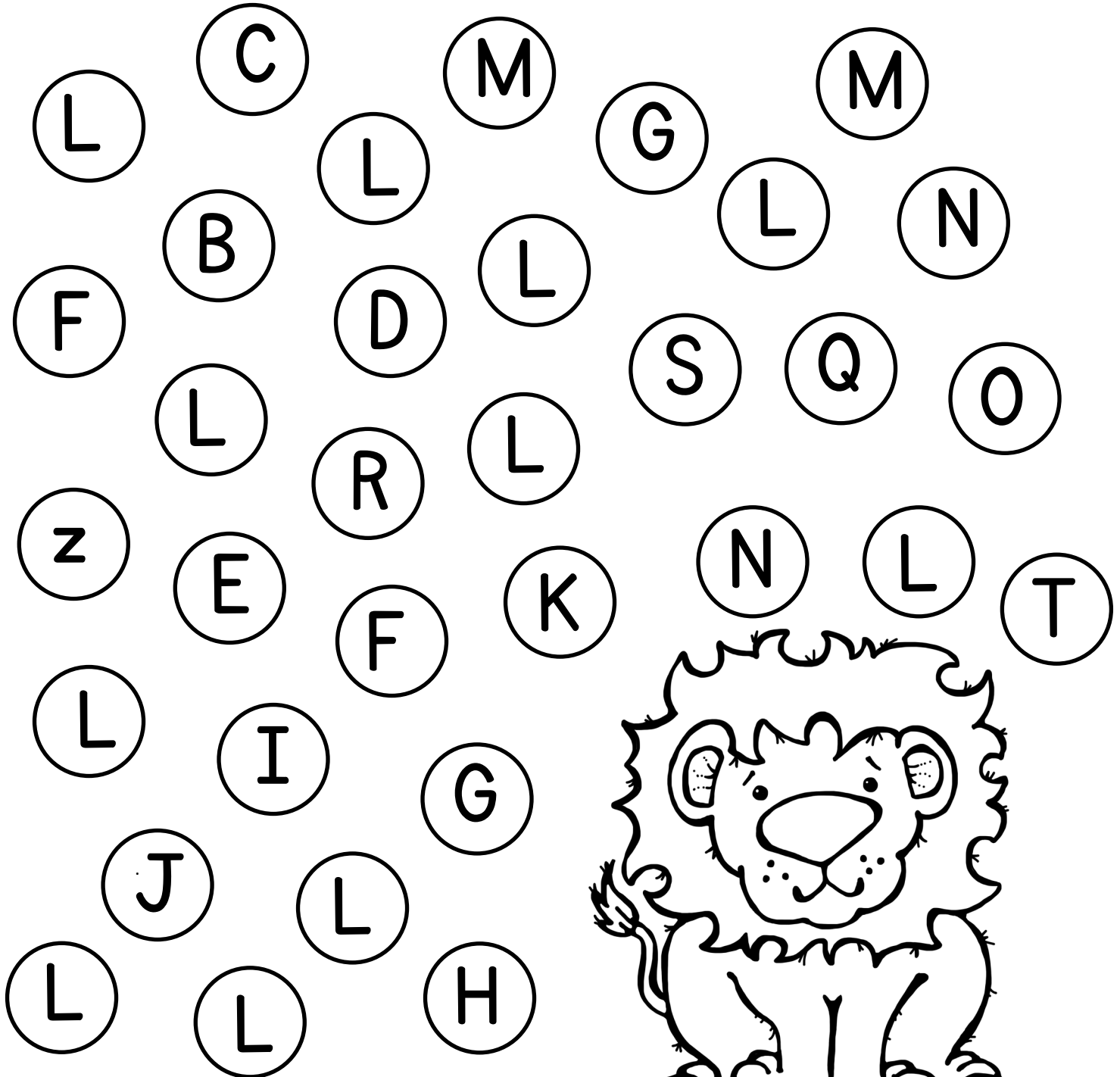

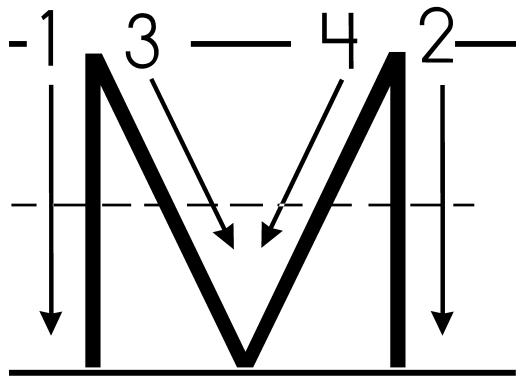

is for
mushroom

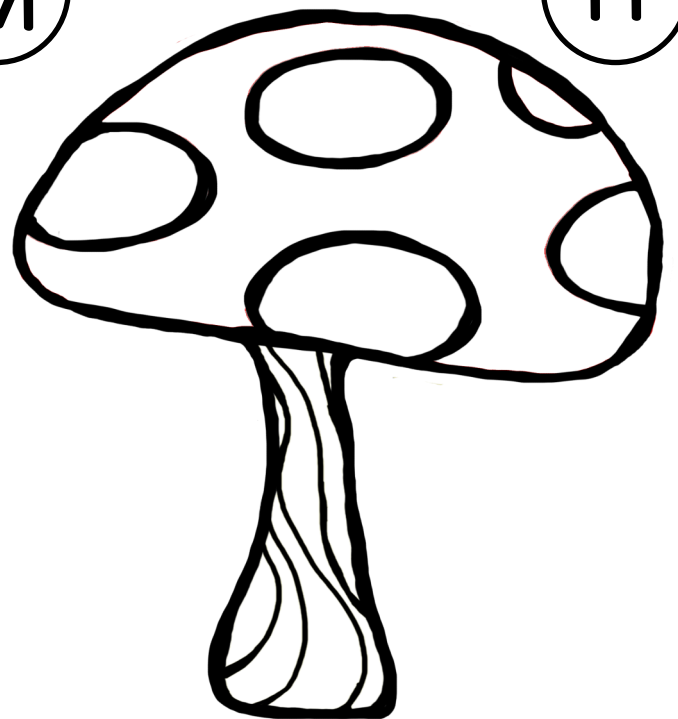
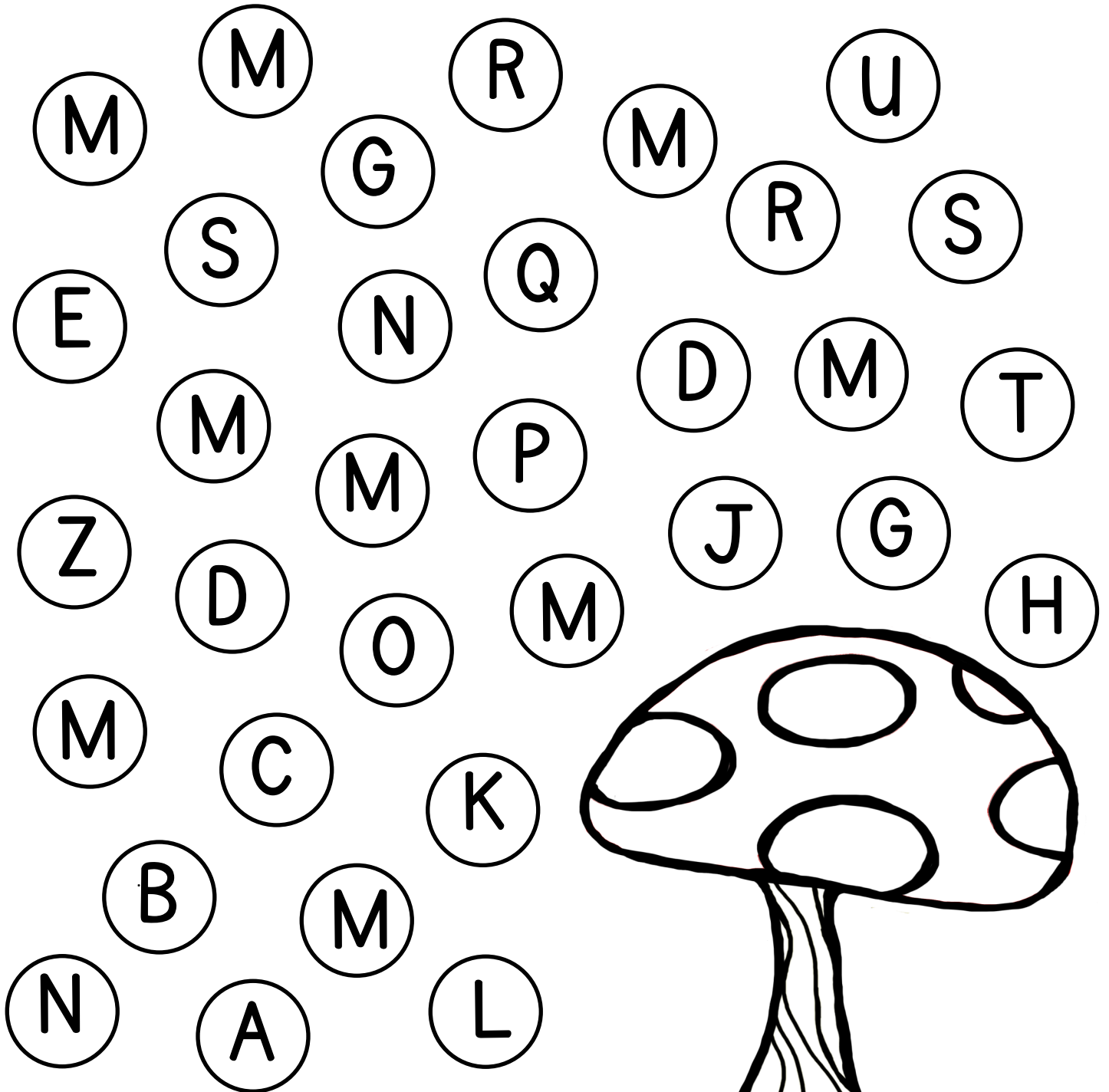

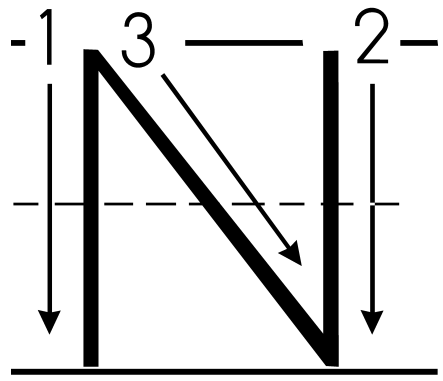

is for
nest

A collection of 30 letters in circles for a word search. The letters are: M, N, S, V, K, U, N, W, A, N, M, I, F, N, Q, B, L, N, G, R, N, J, T, X, K, S, L, D, N, N, N, C.



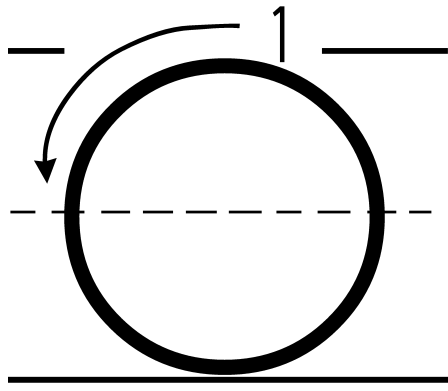

is for
octopus

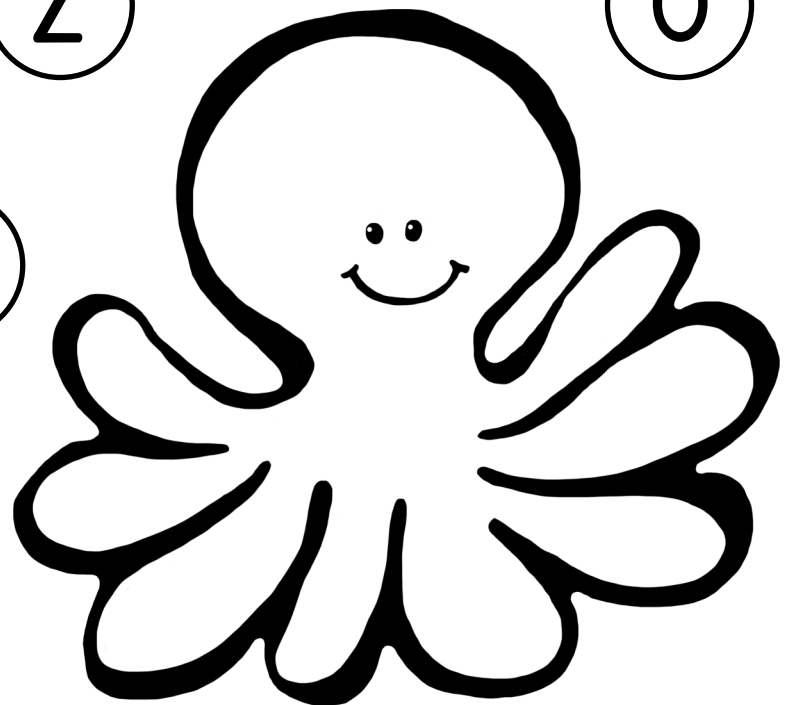
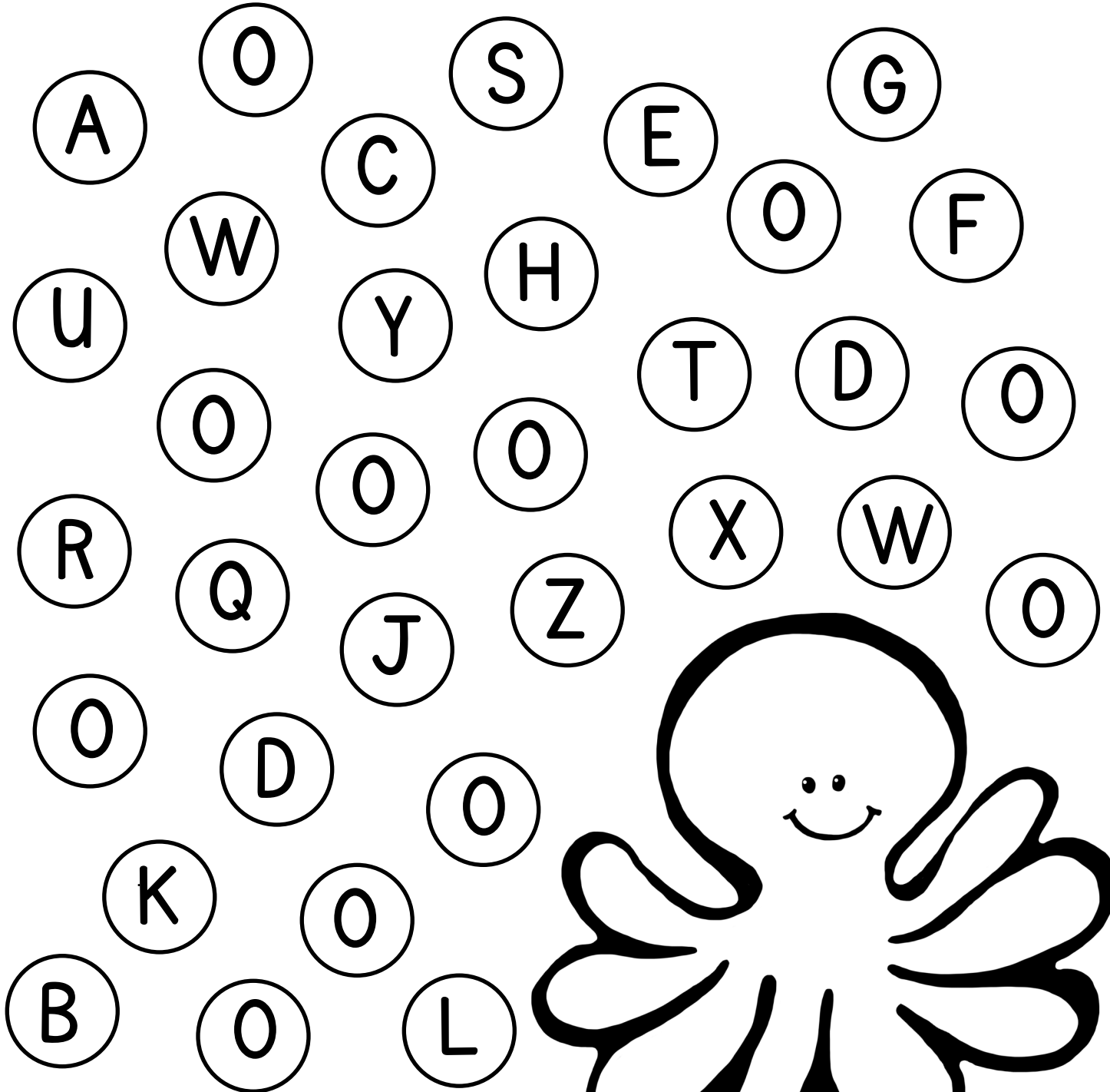

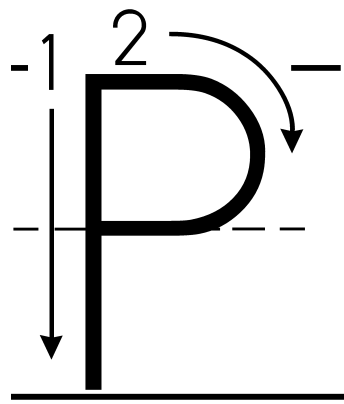

is for
pig

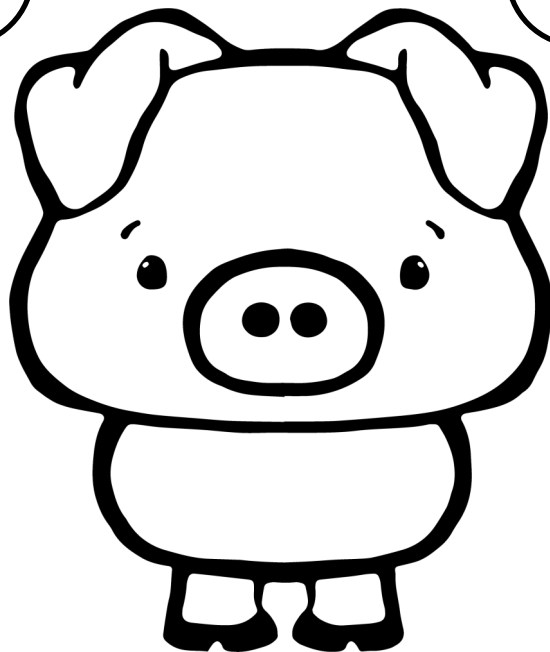
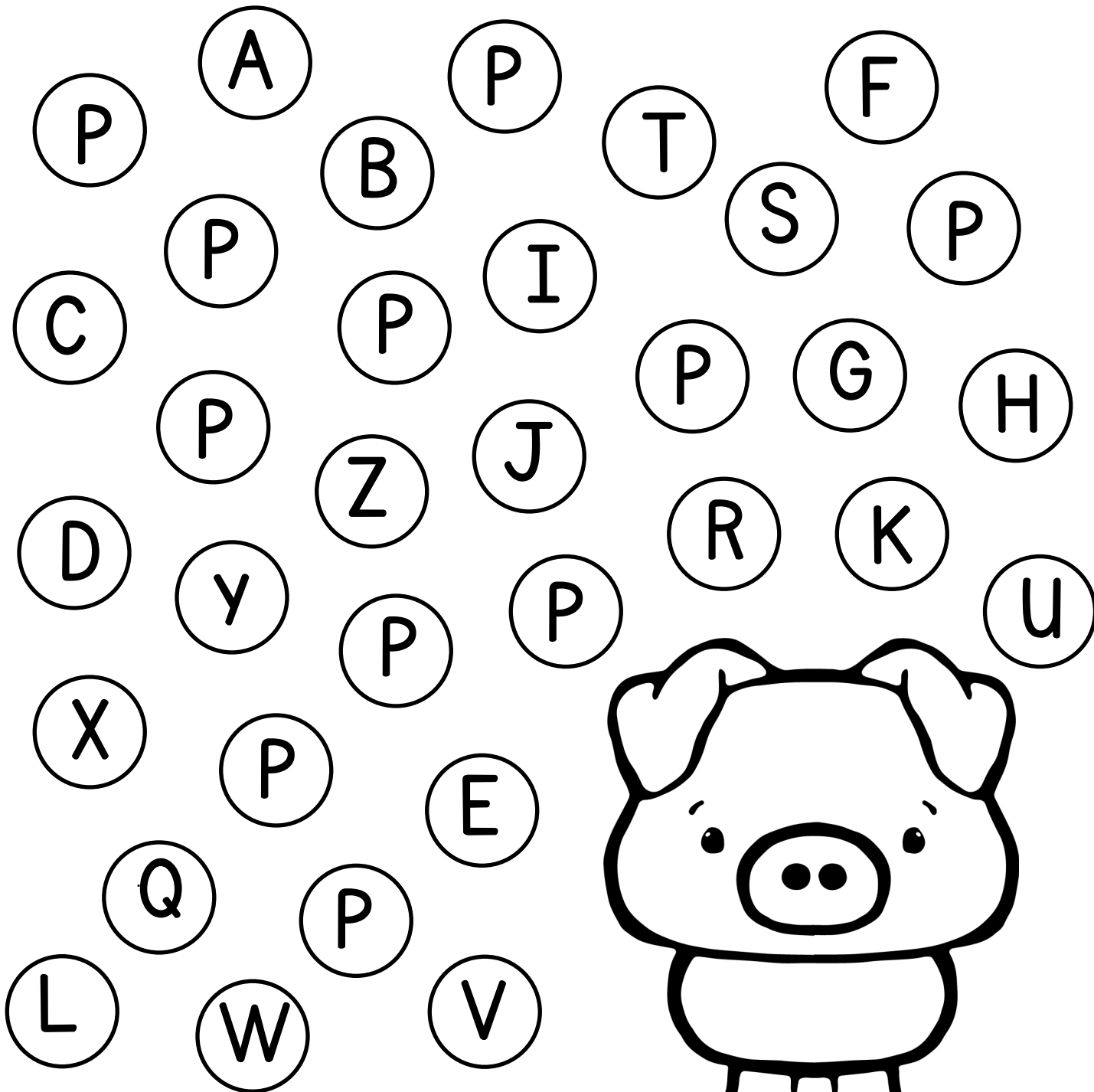

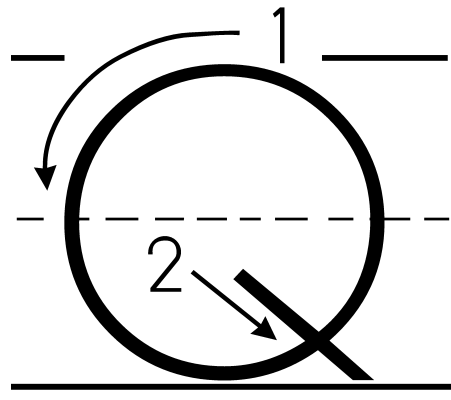

is for
queen

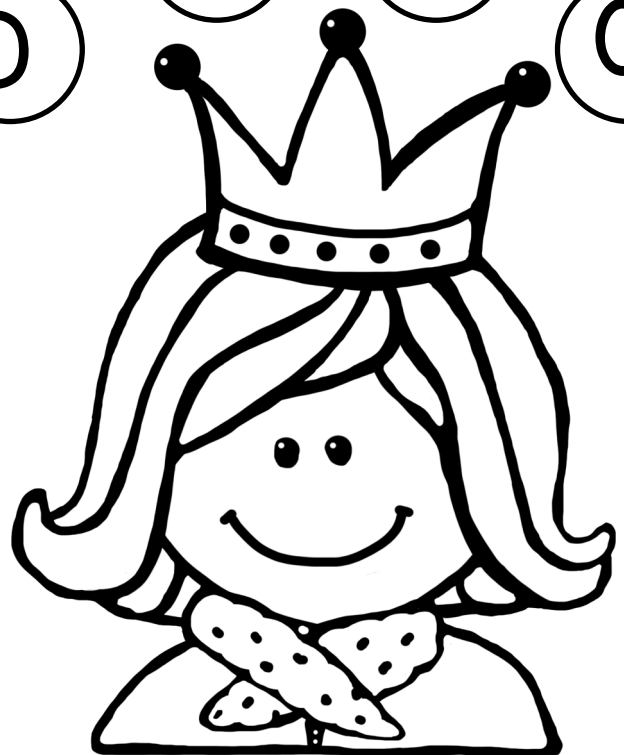
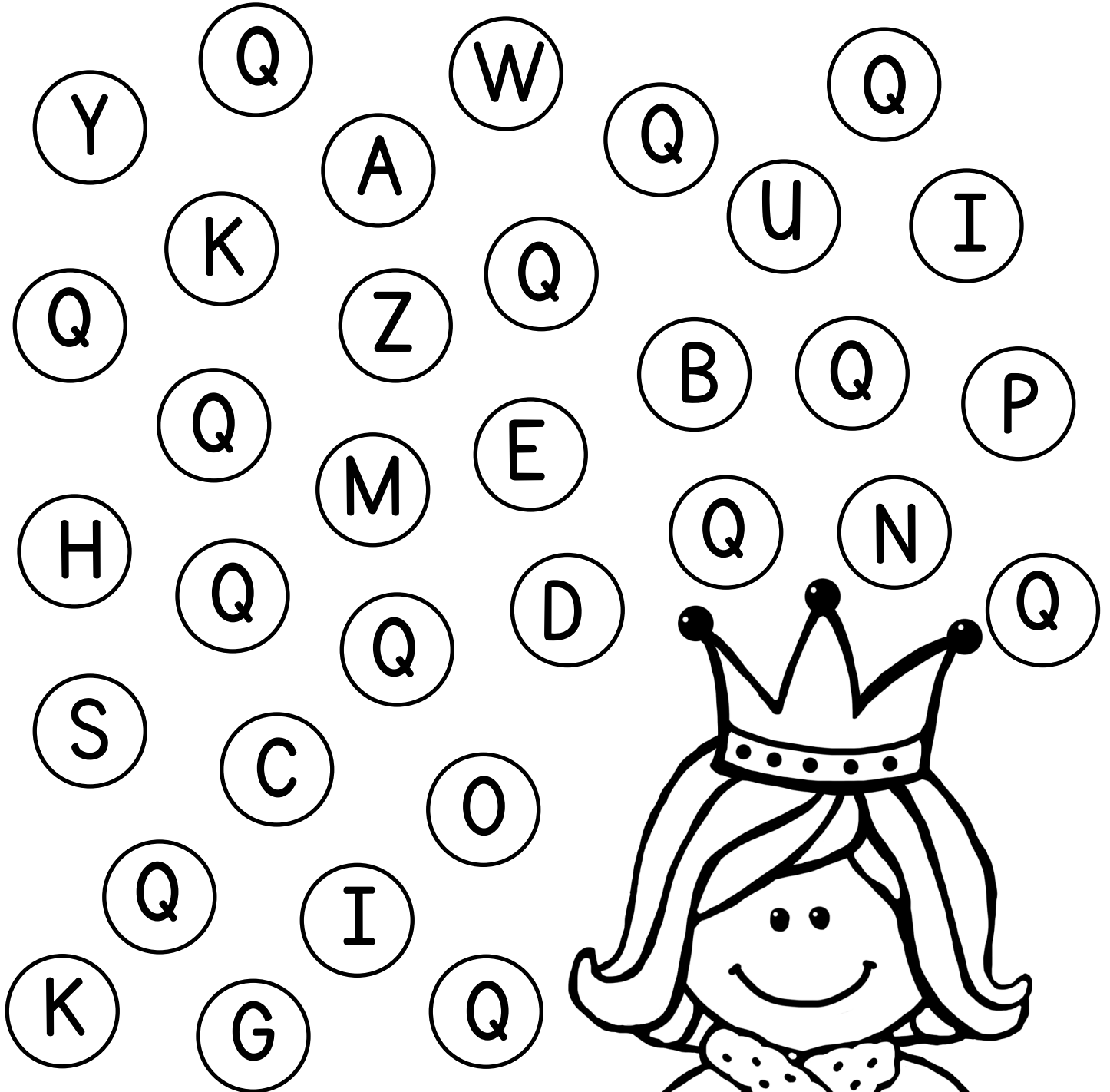

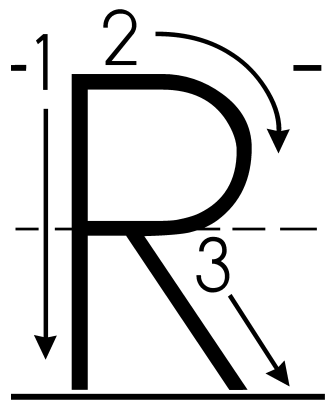

is for
rabbit

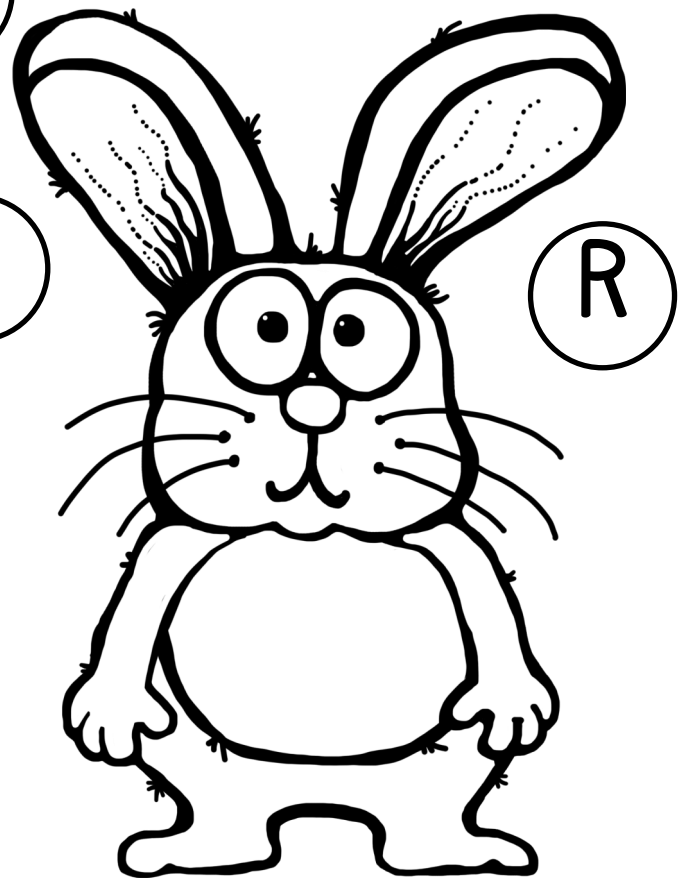
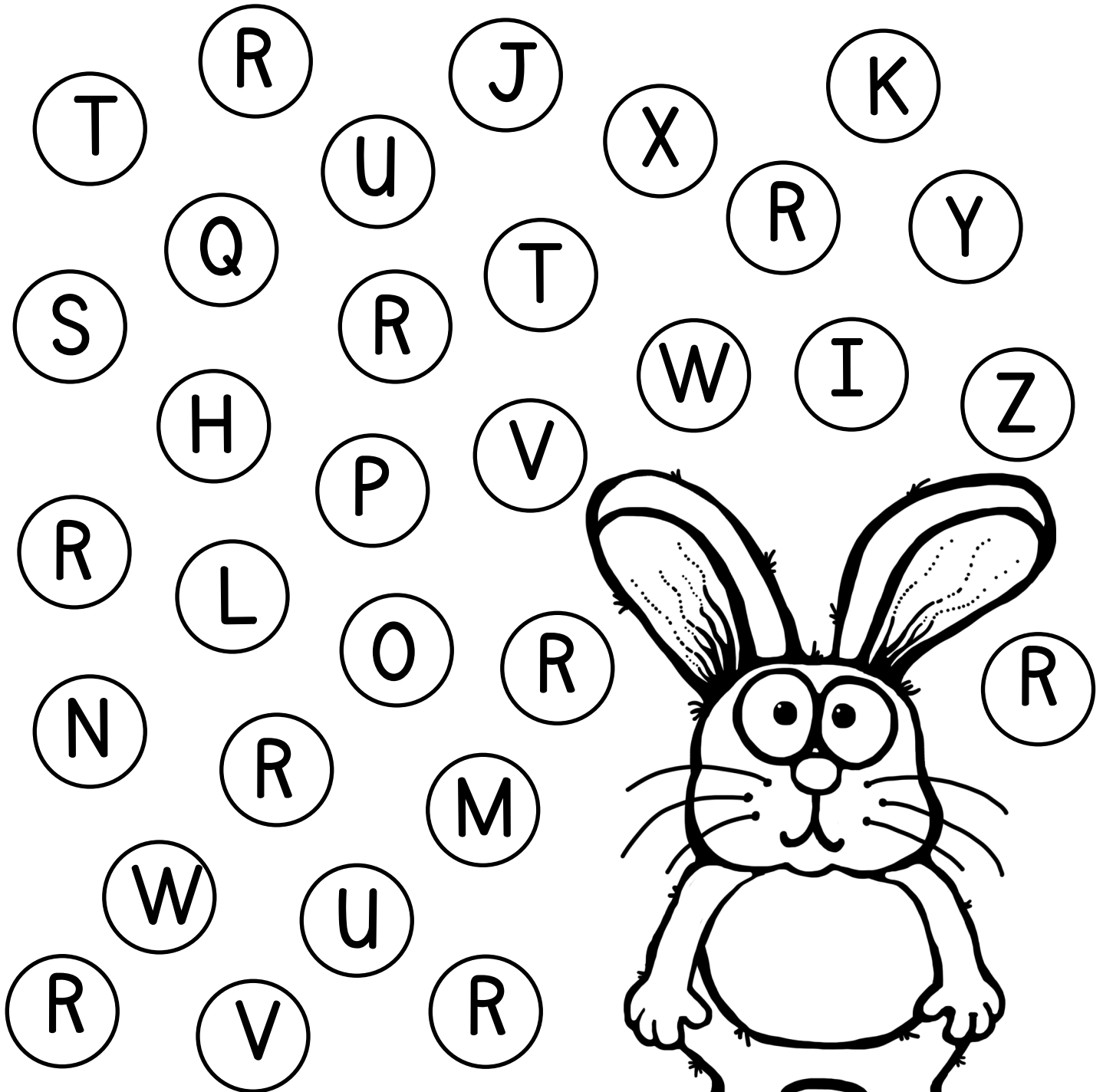

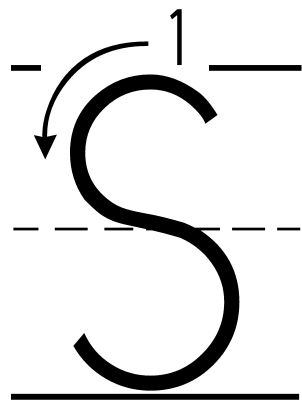

is for
snake

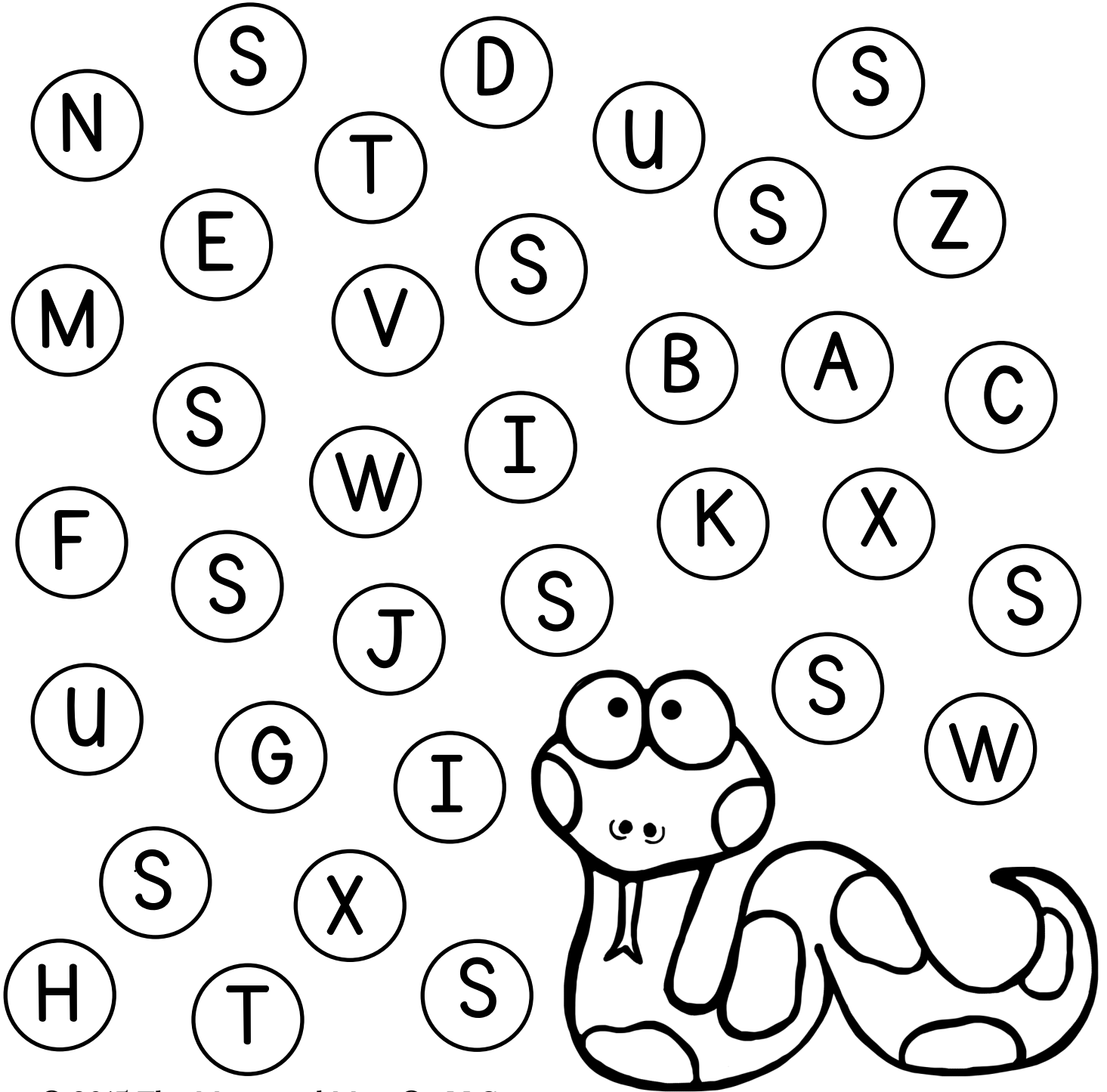

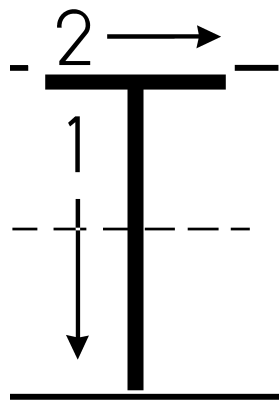

is for
turtle

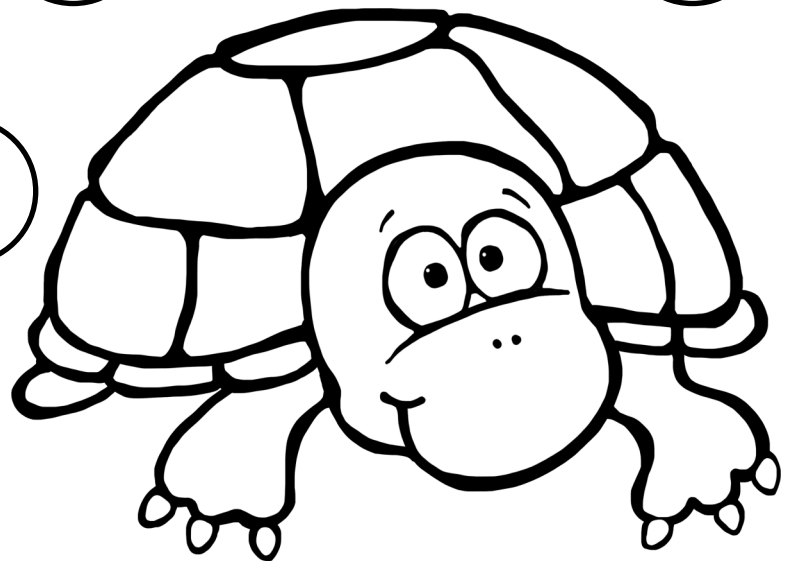
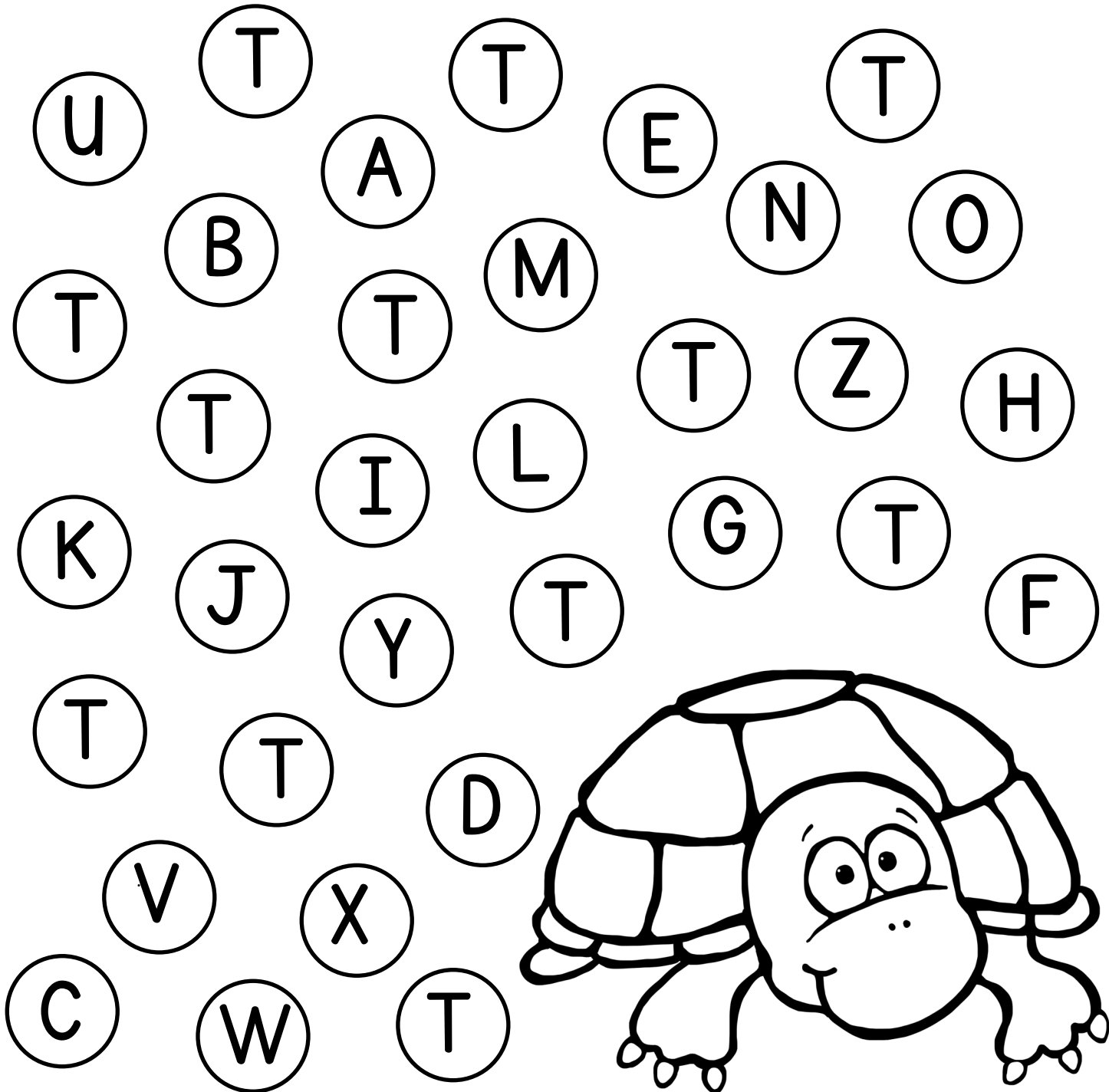

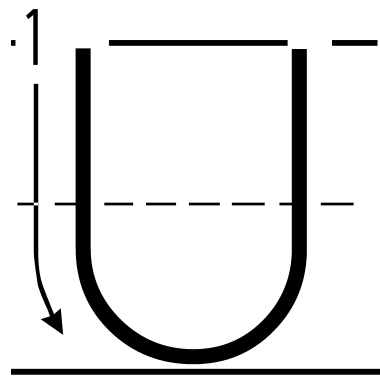

is for
umbrella

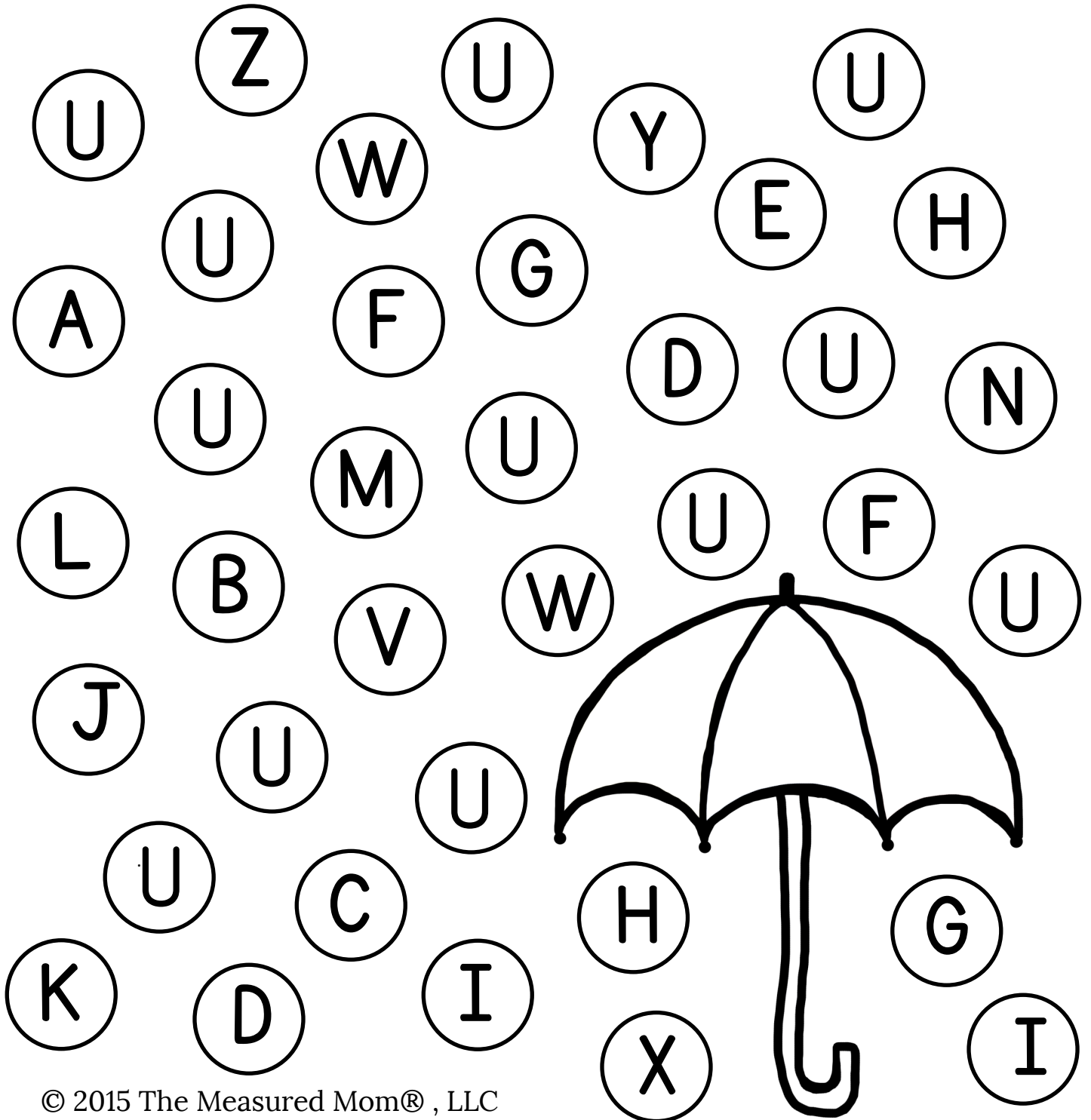

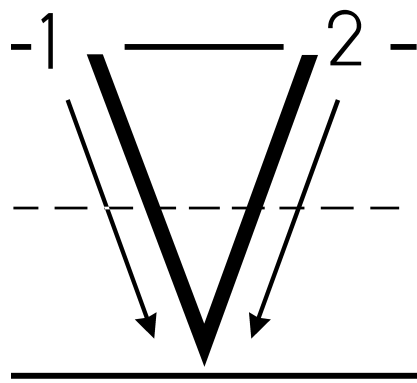

V is for
volcano

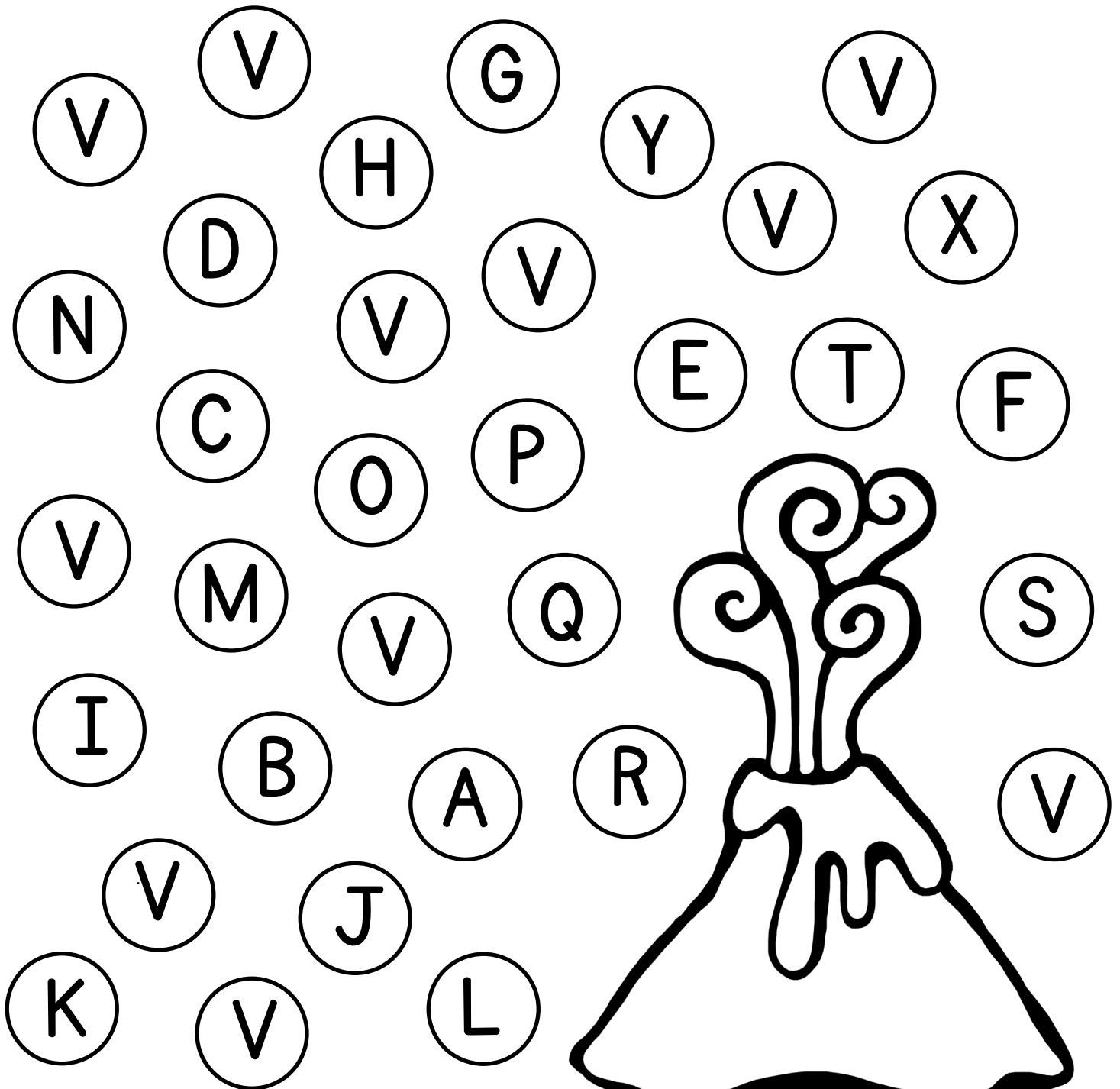

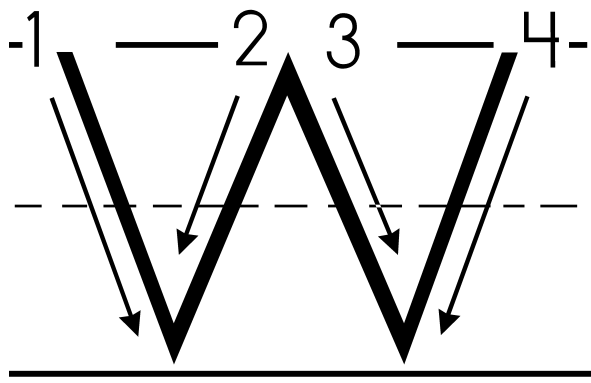

is for
whale

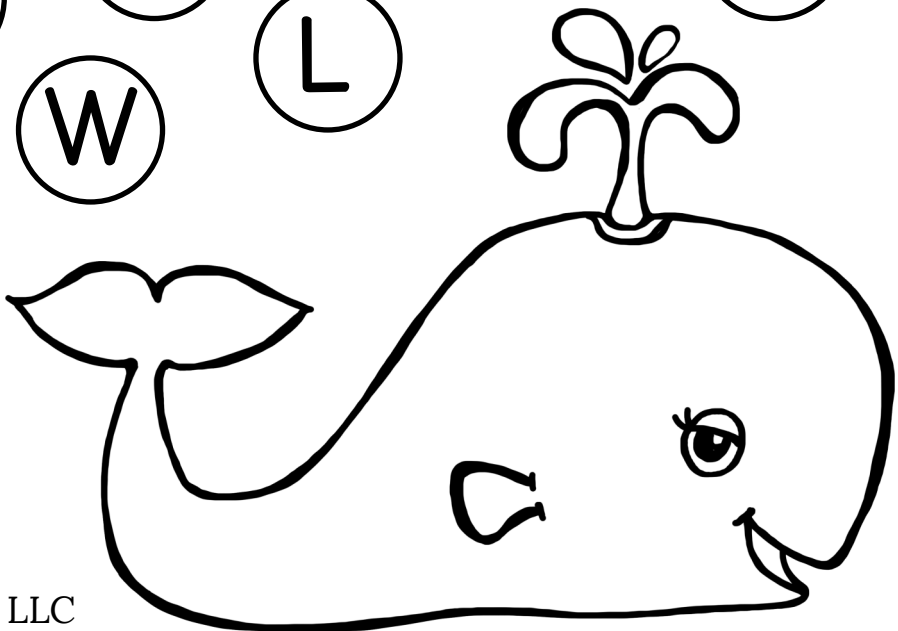
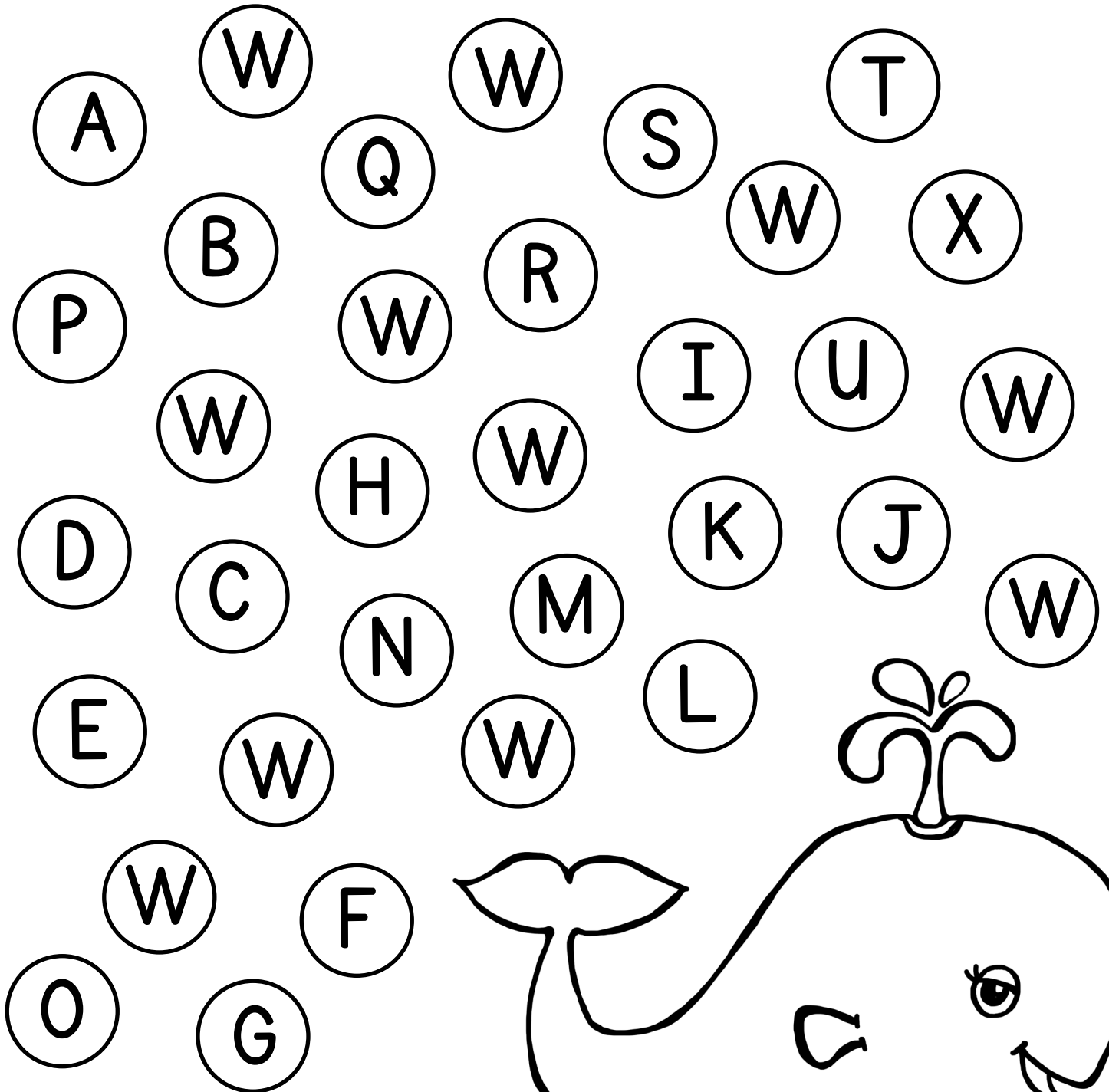

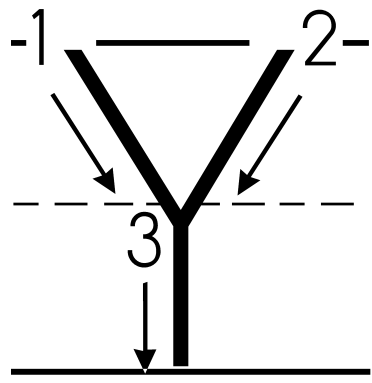

is for
yarn

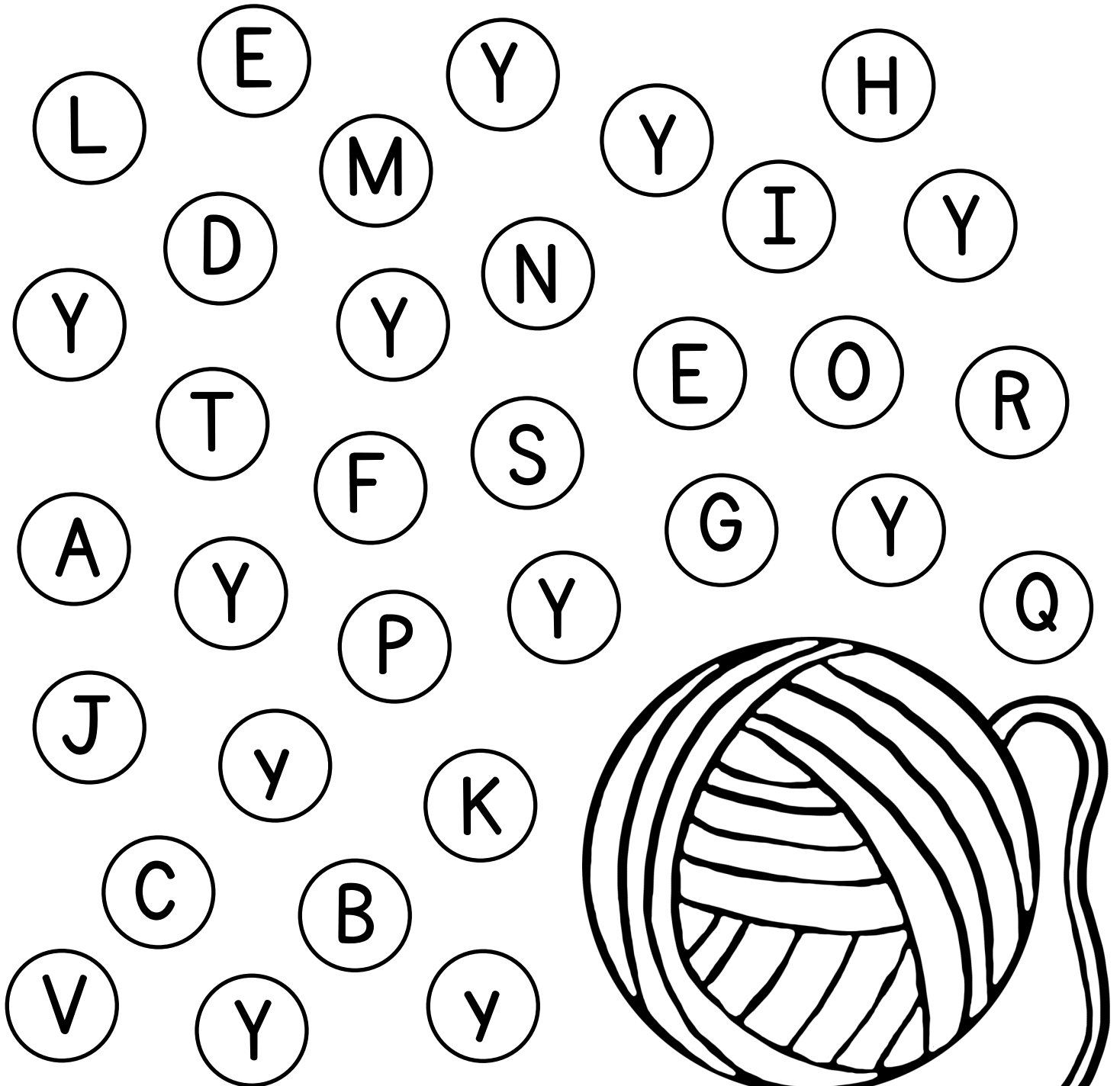

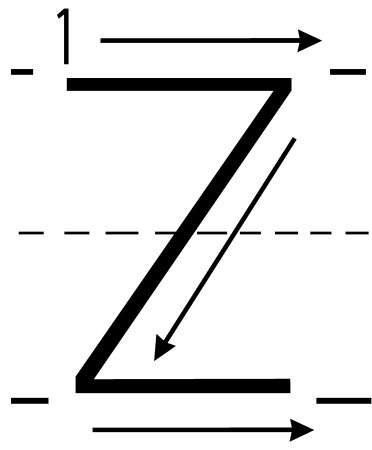

is for
zebra

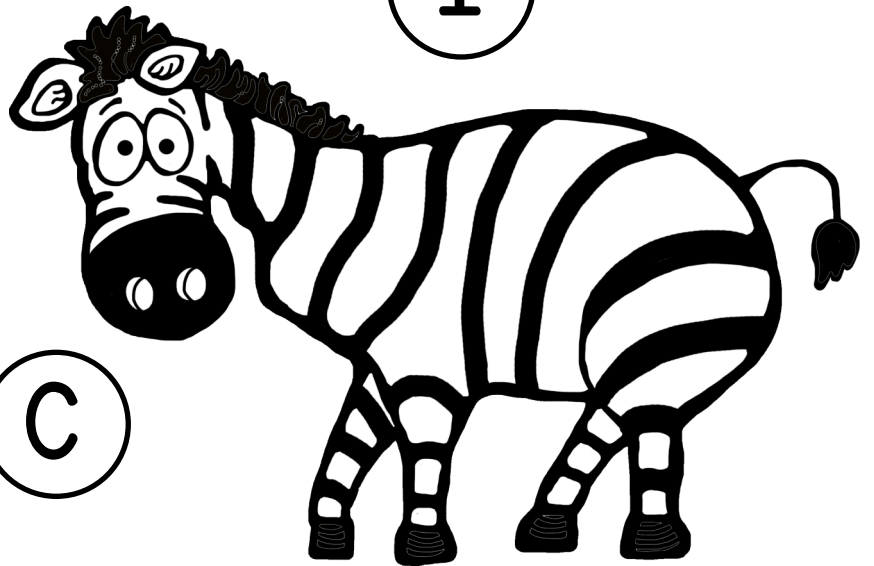
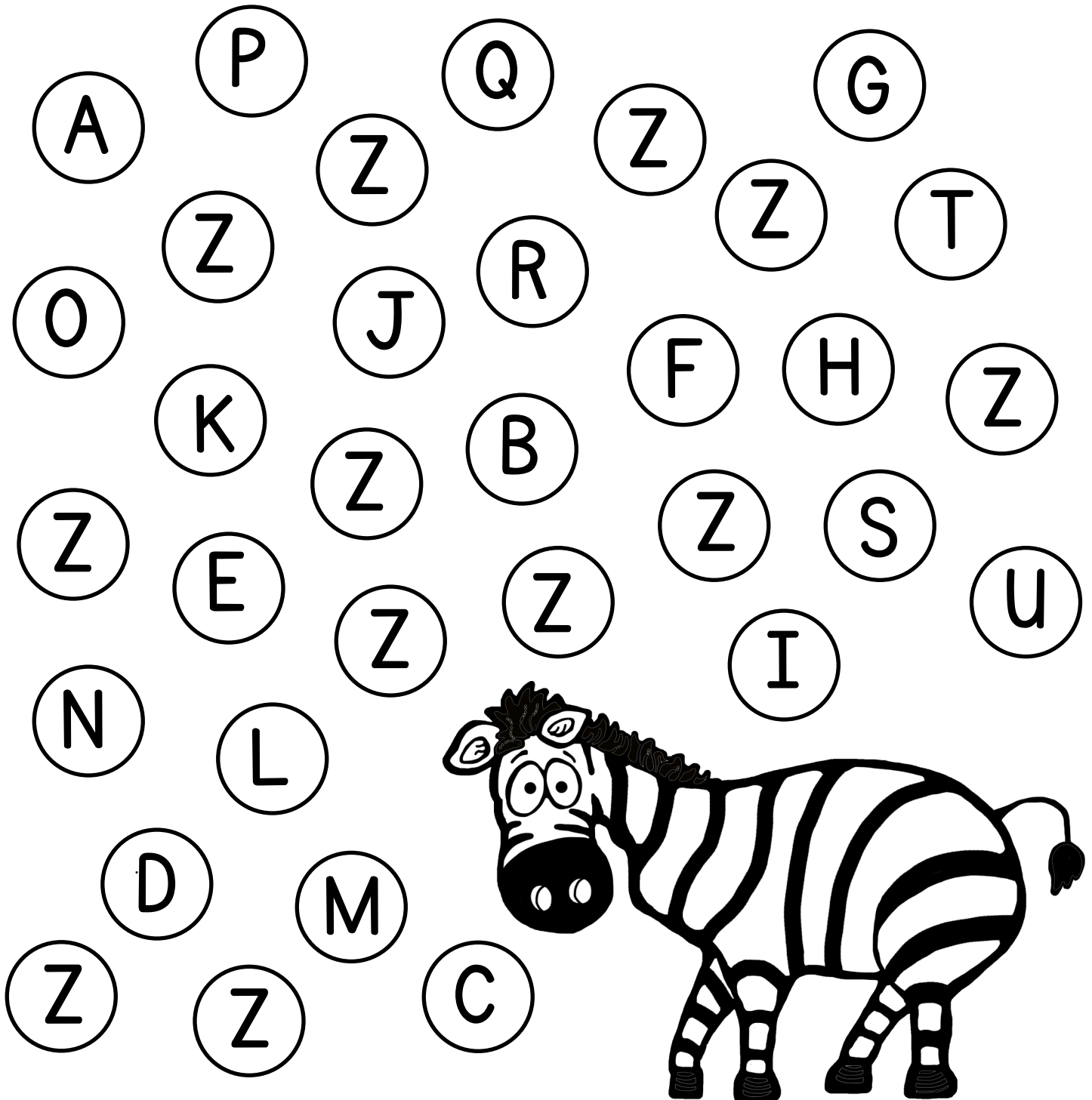

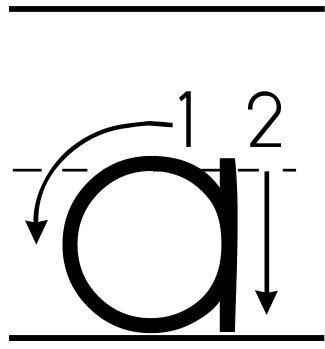

is for
apple

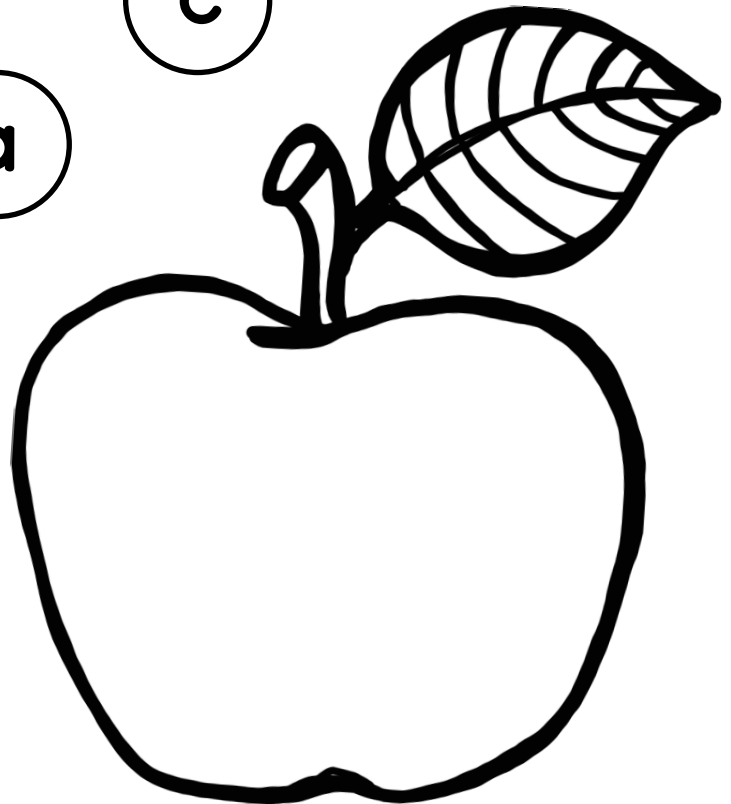
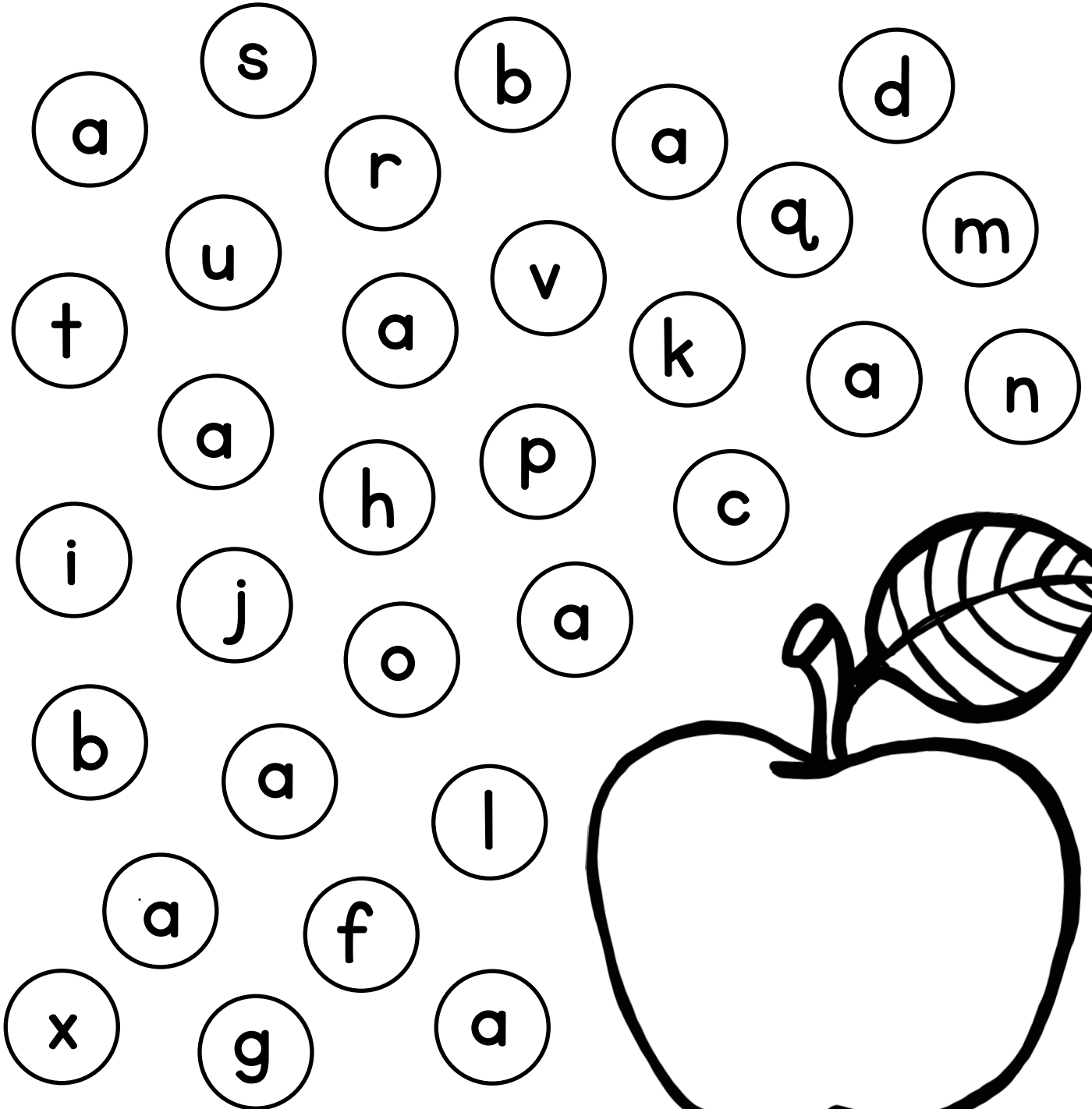

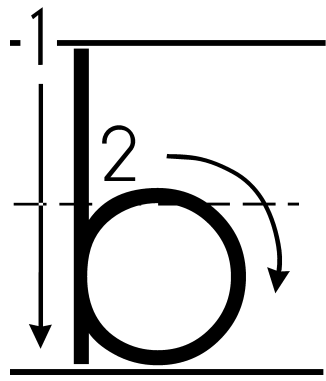

is for
bird

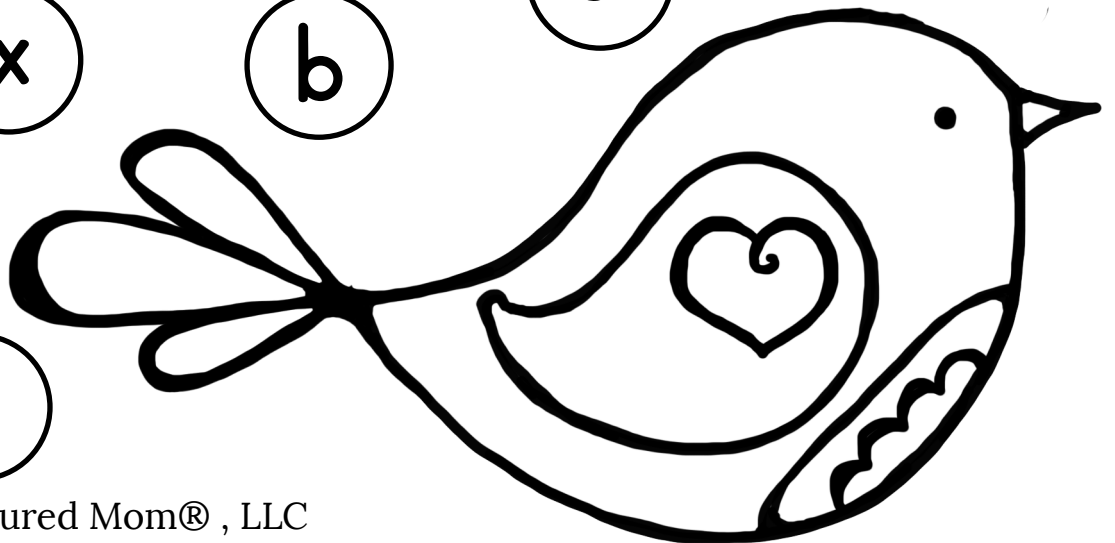
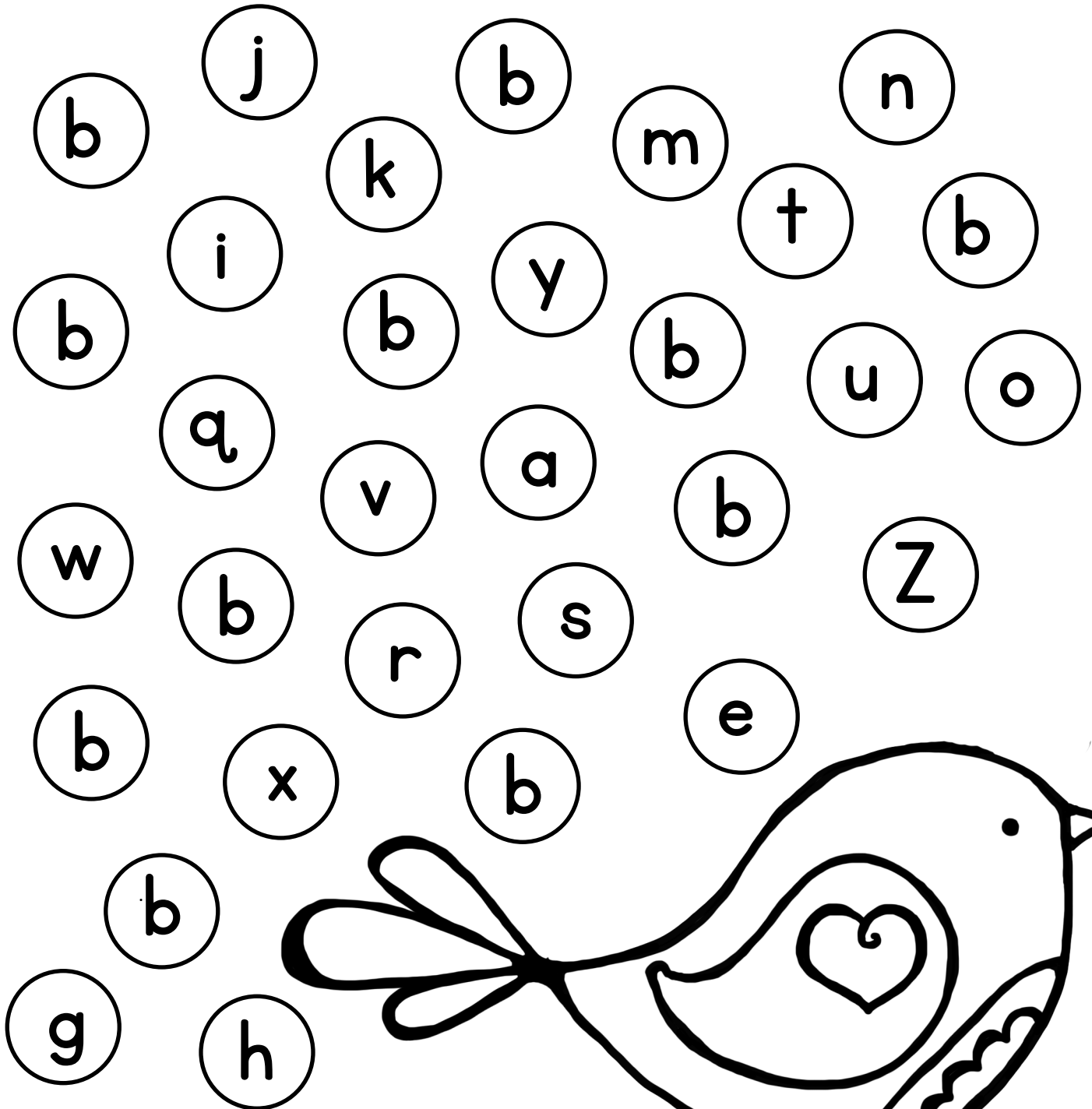

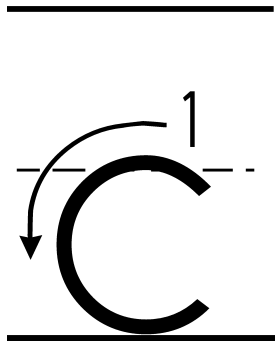

is for
cat

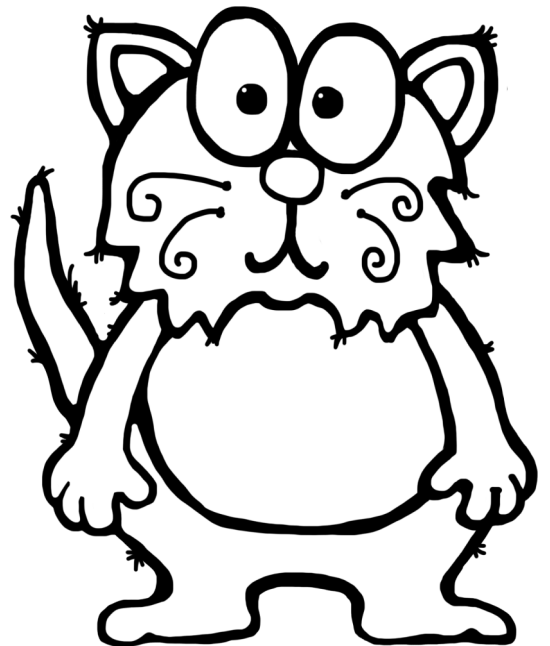
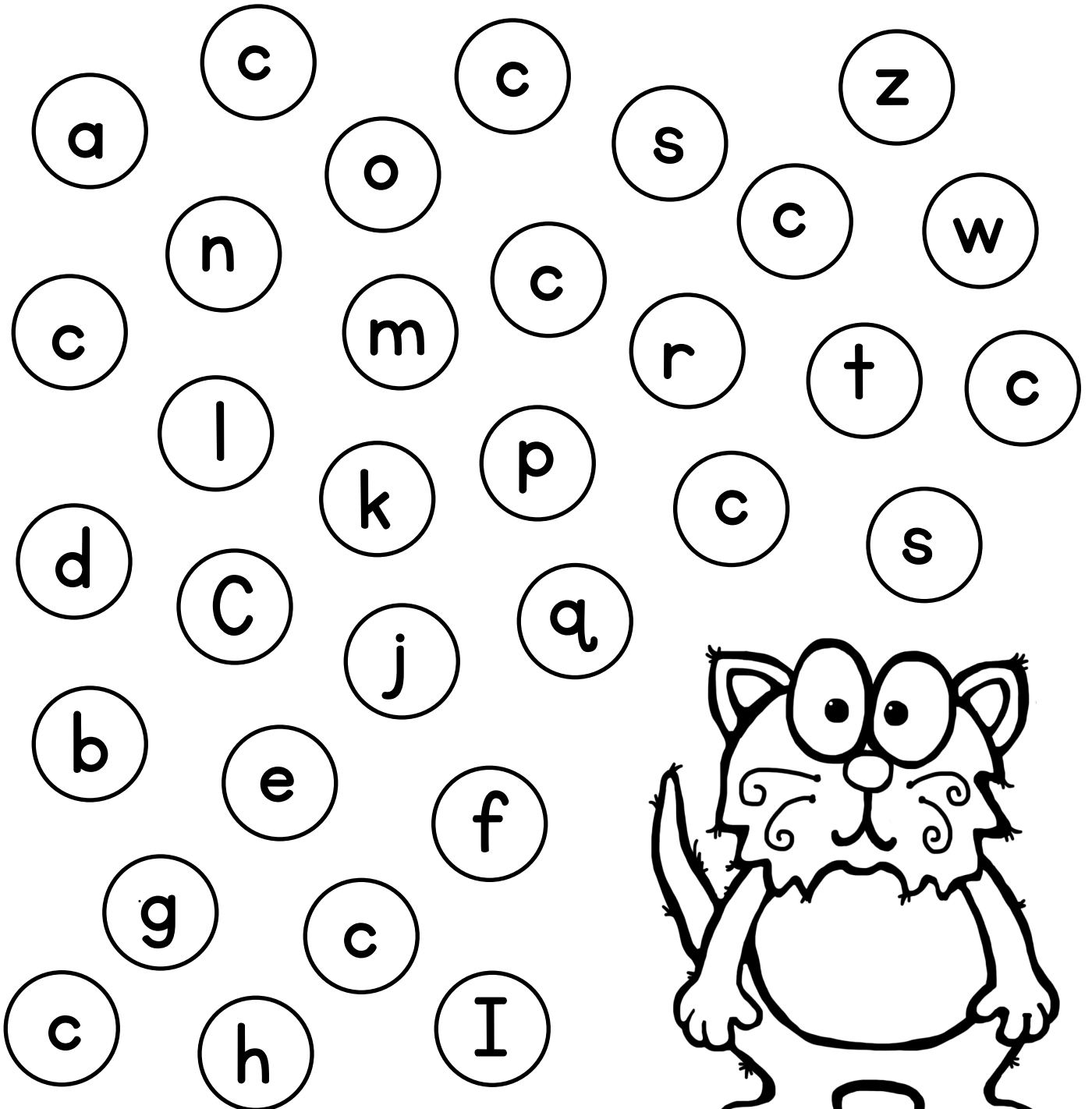

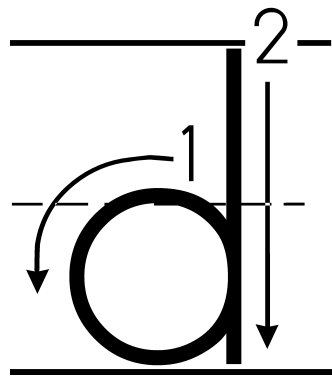

is for
dinosaur

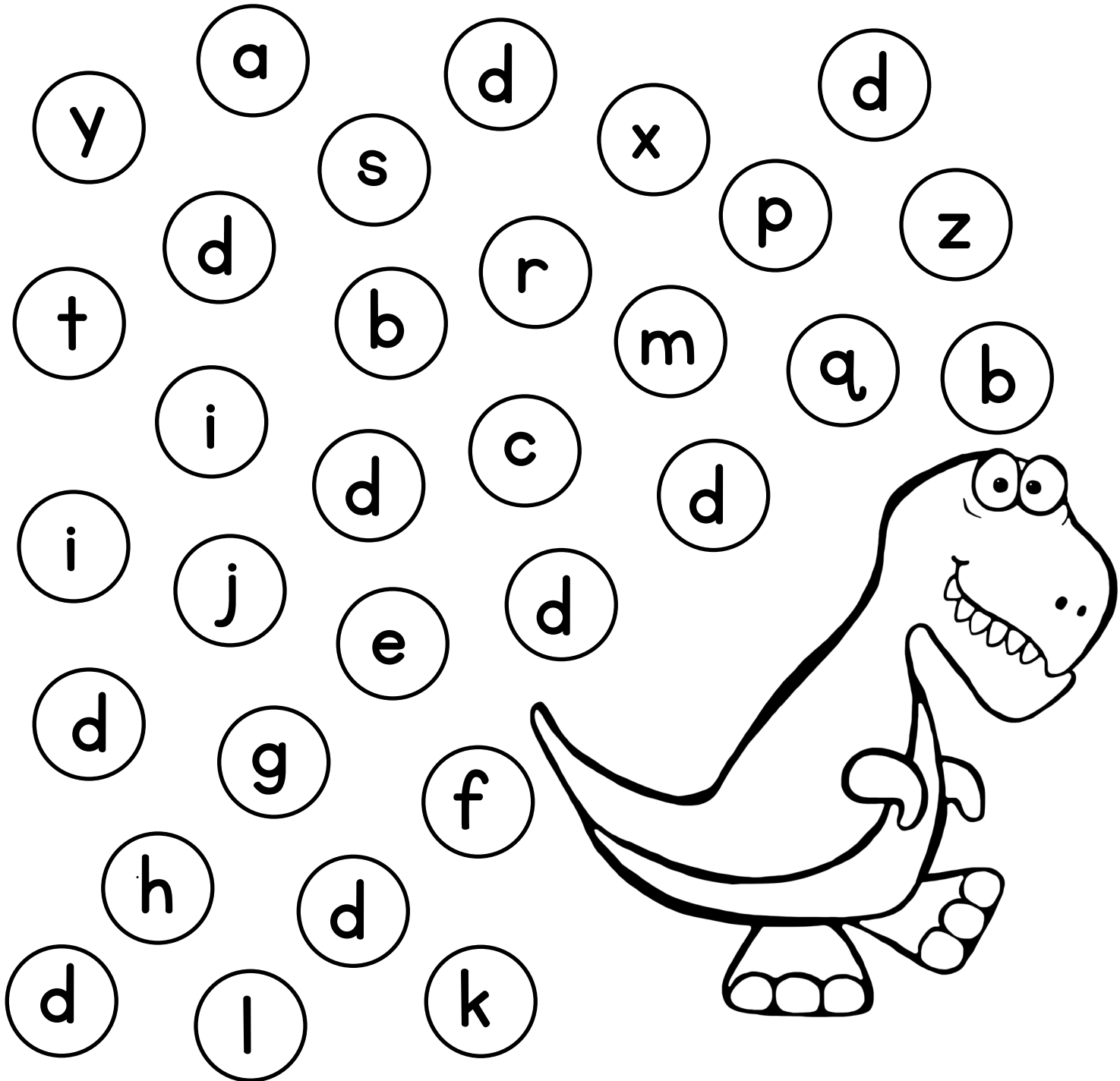

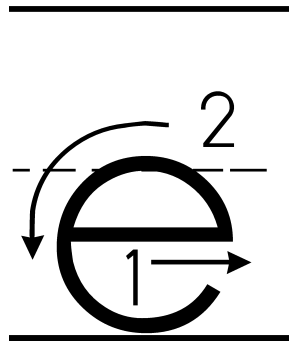

is for
elephant

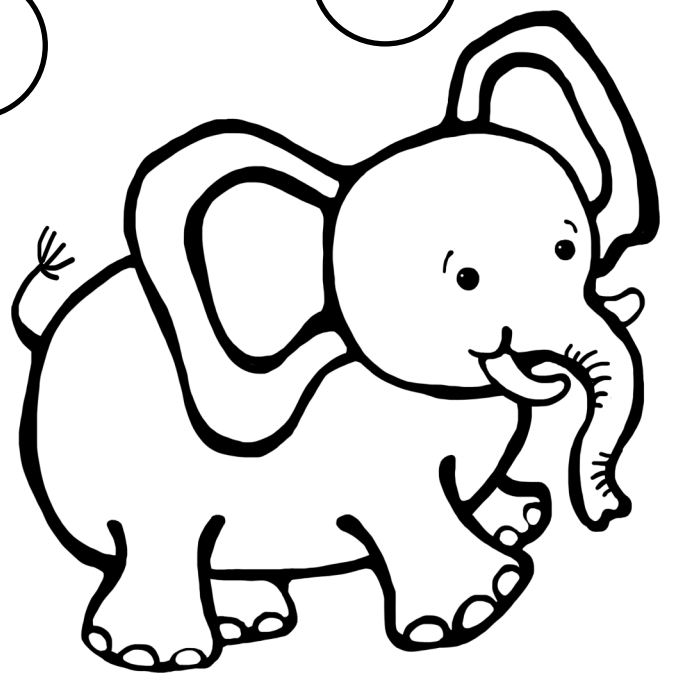
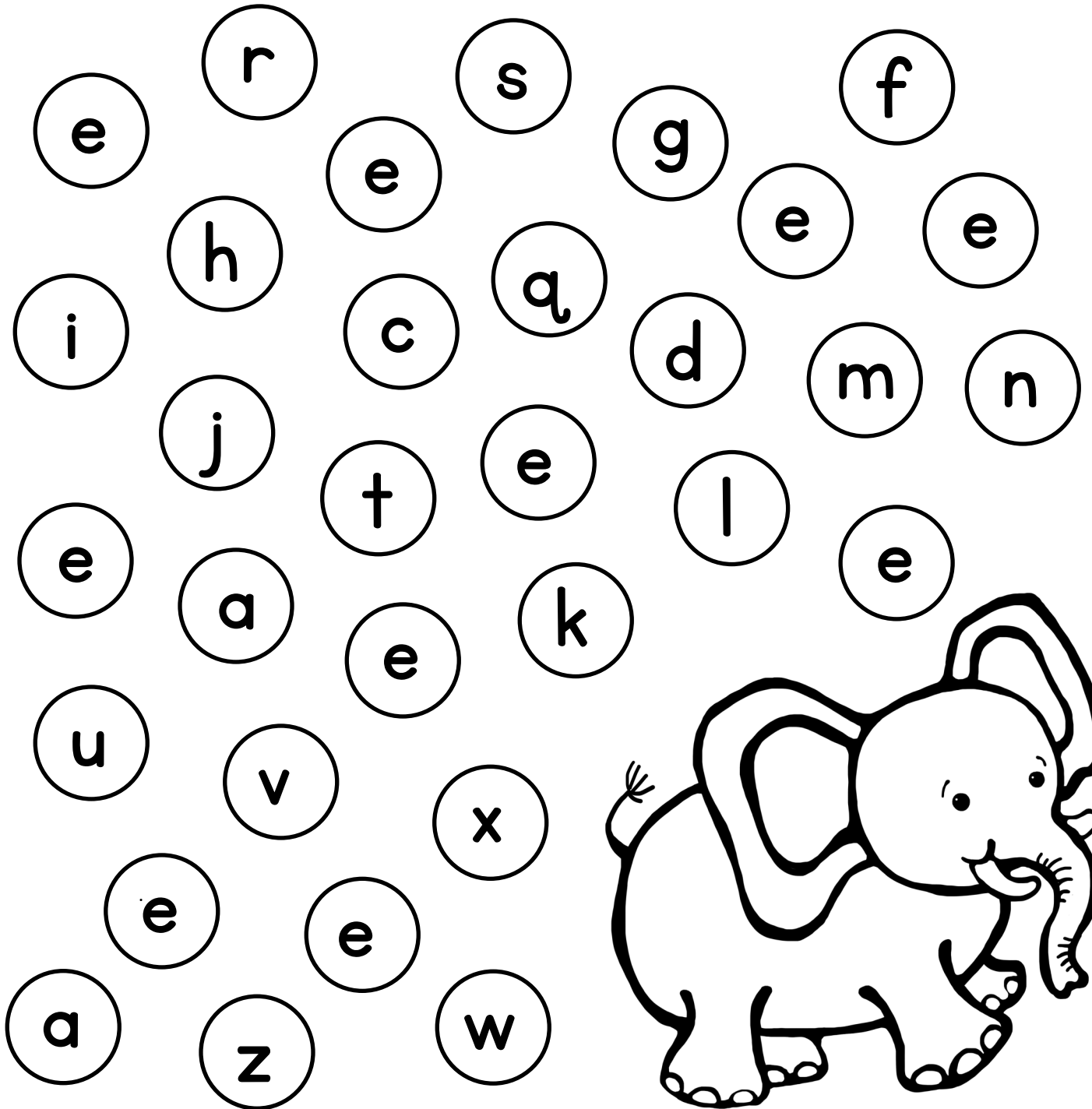

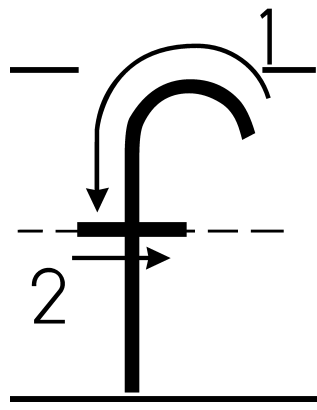

is for
frog

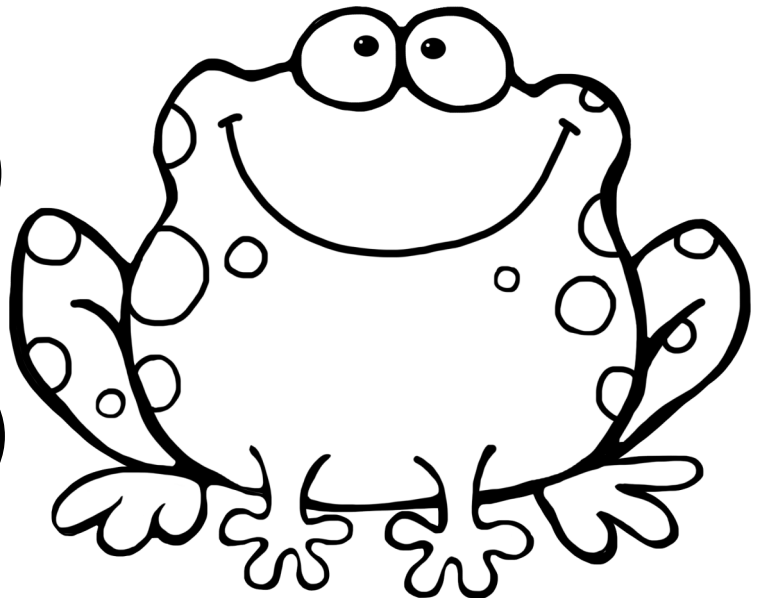
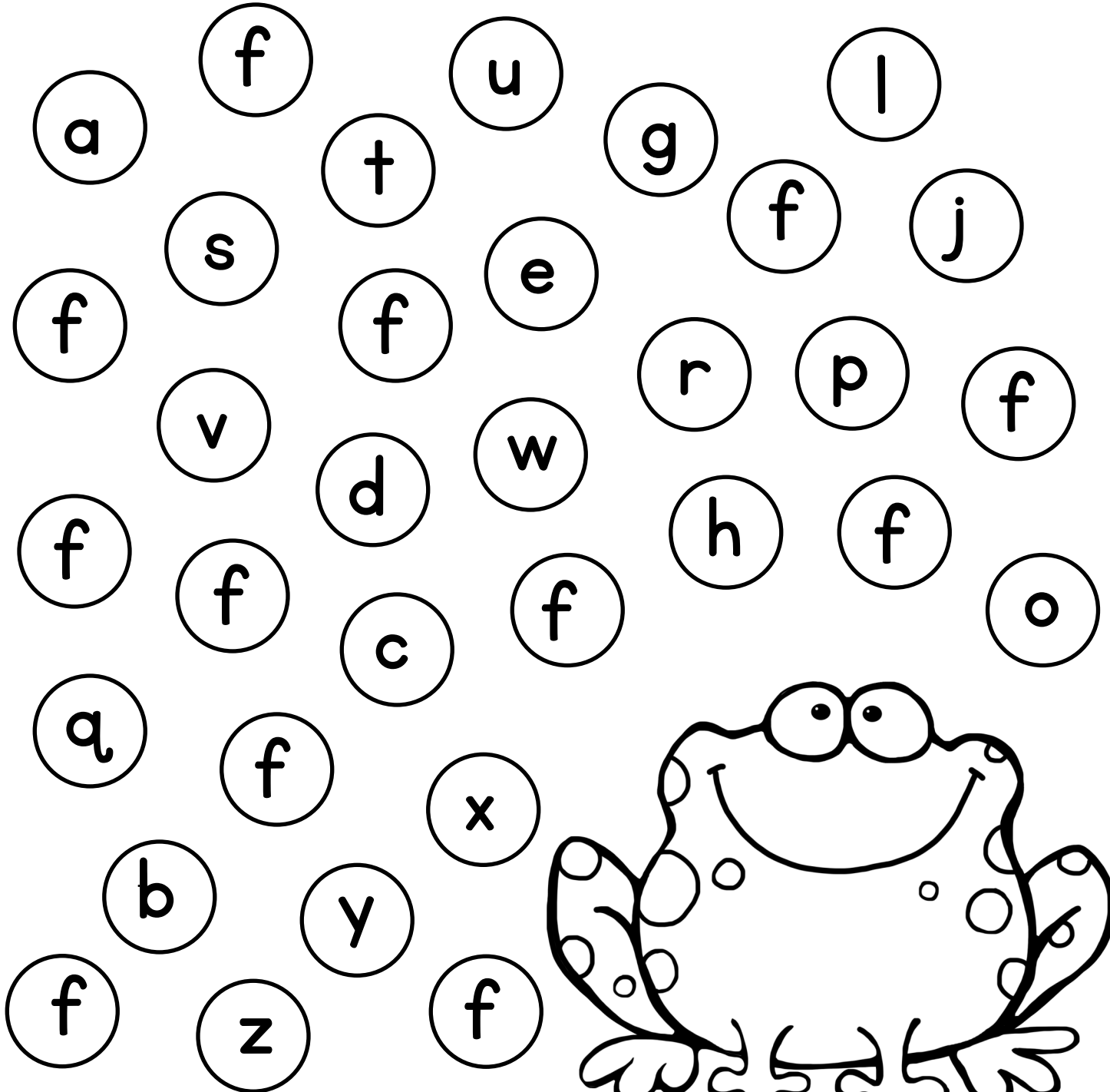

is for
gumballs

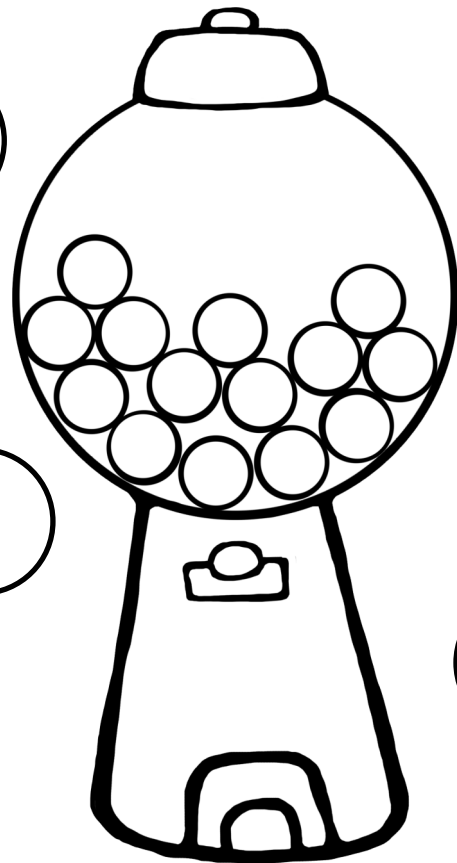
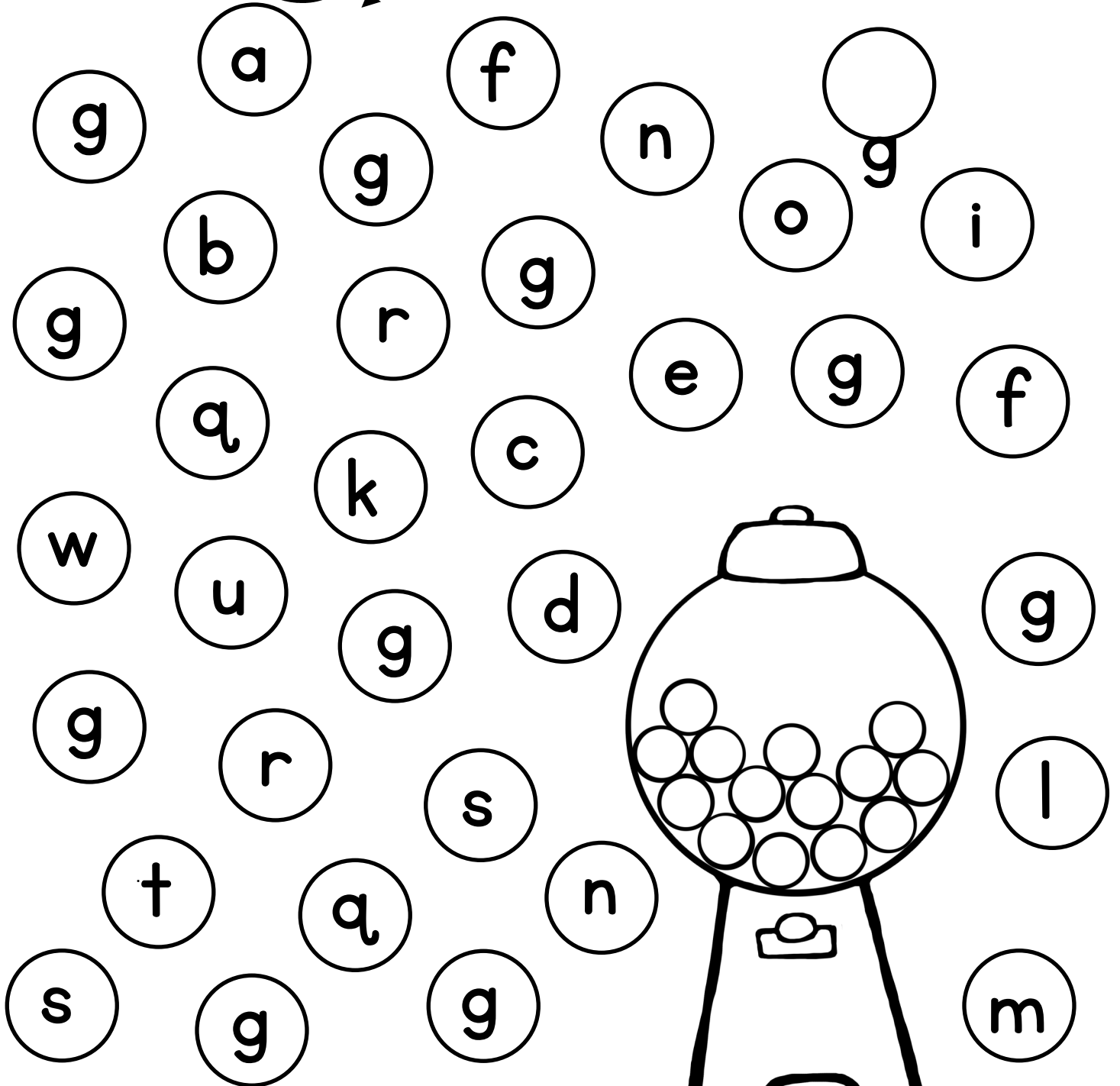
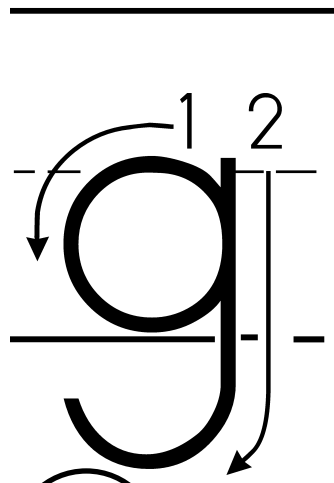

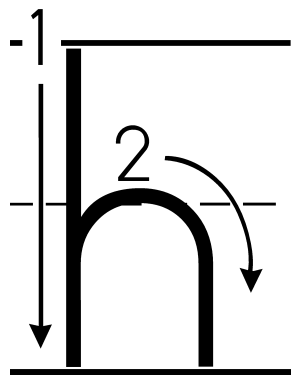

is for
hippo

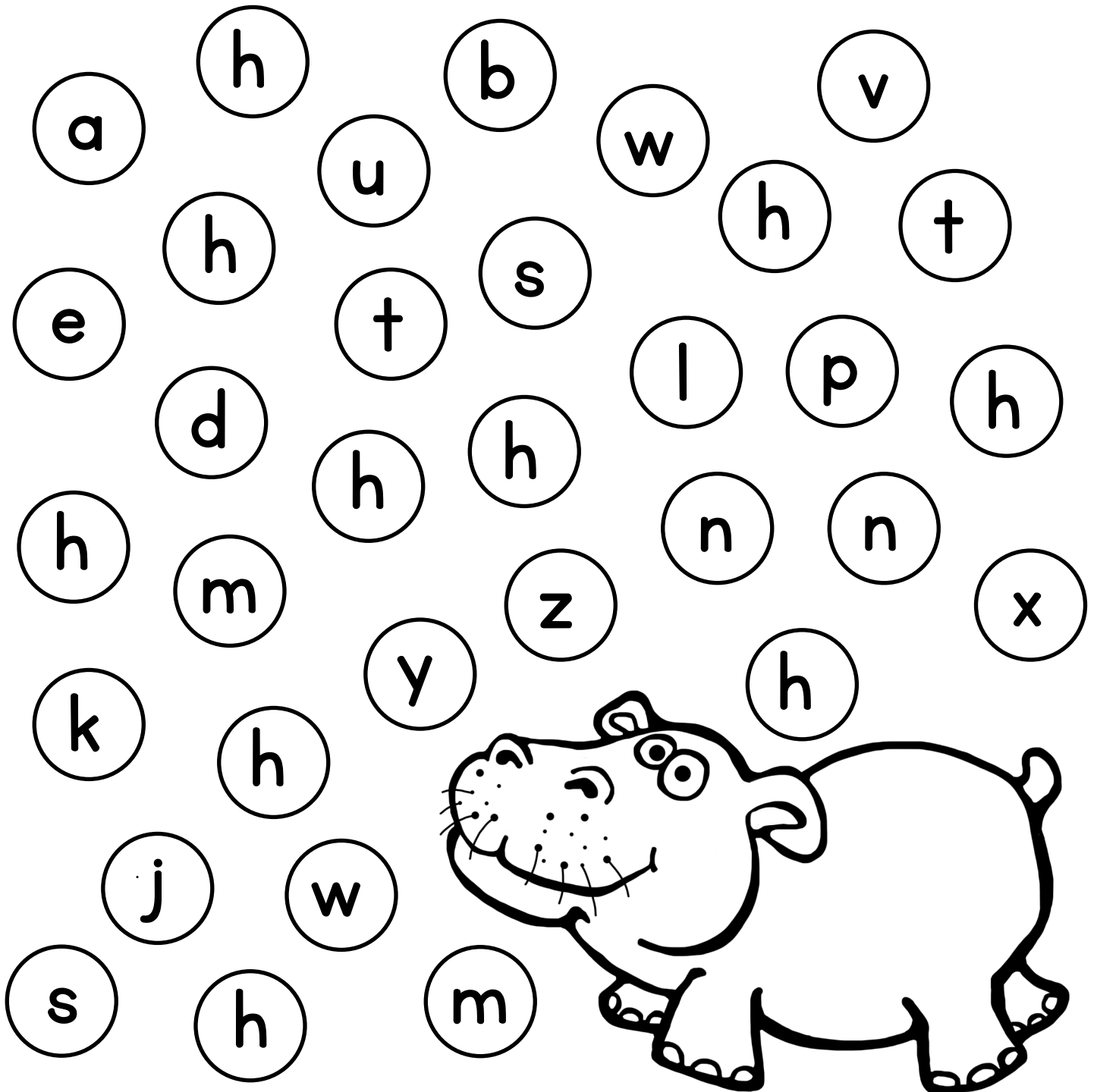

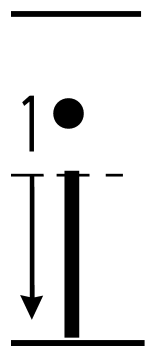

is for
igloo

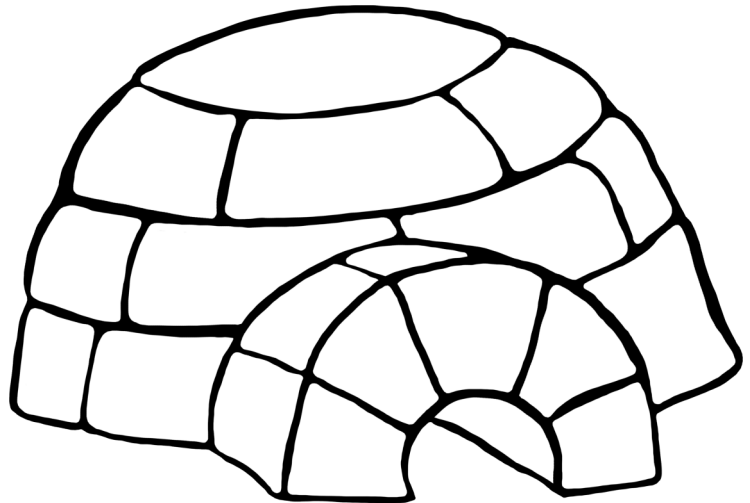
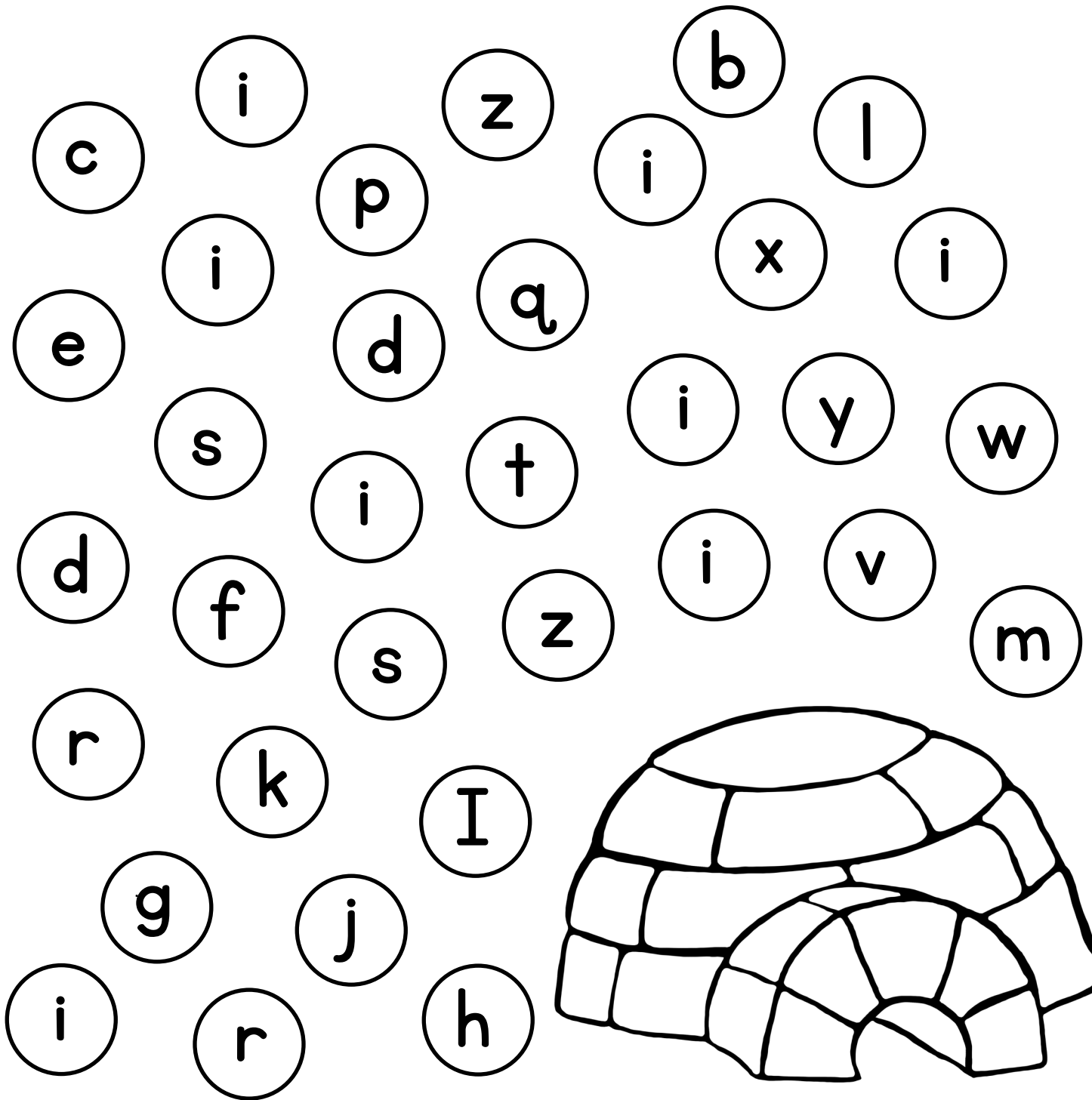

is for
jellyfish

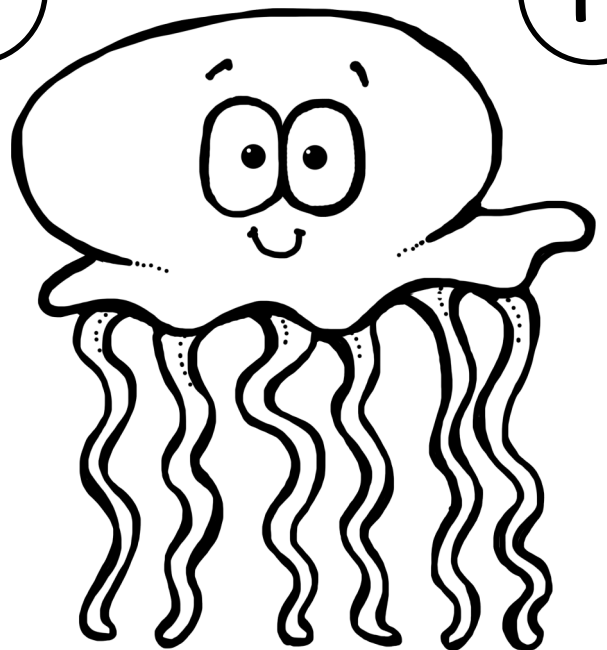
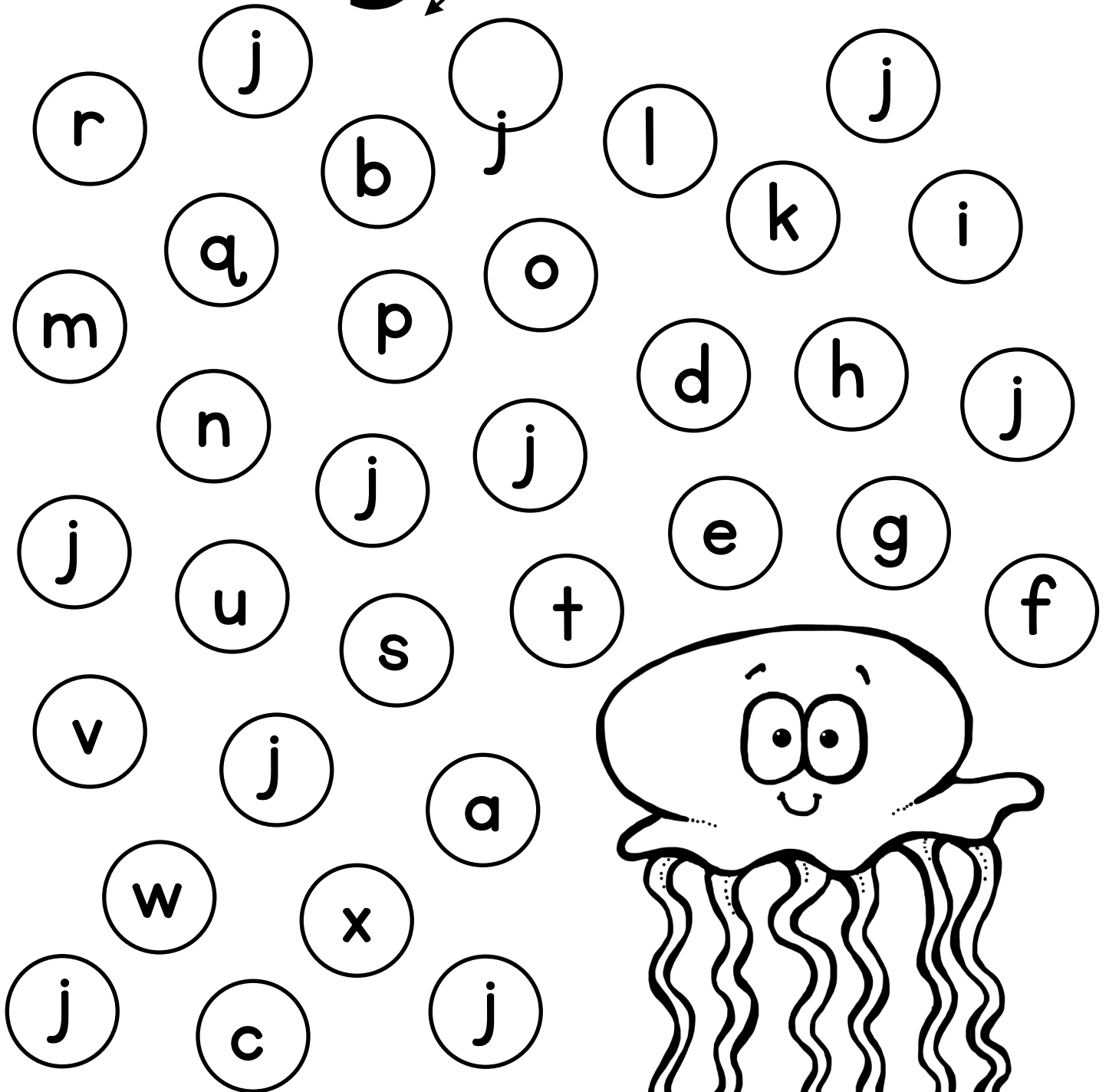
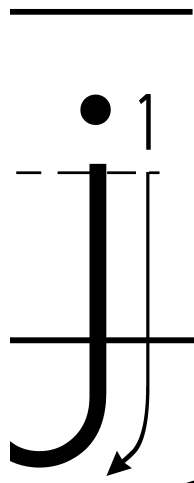

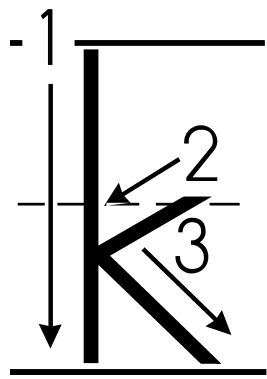

is for
koala

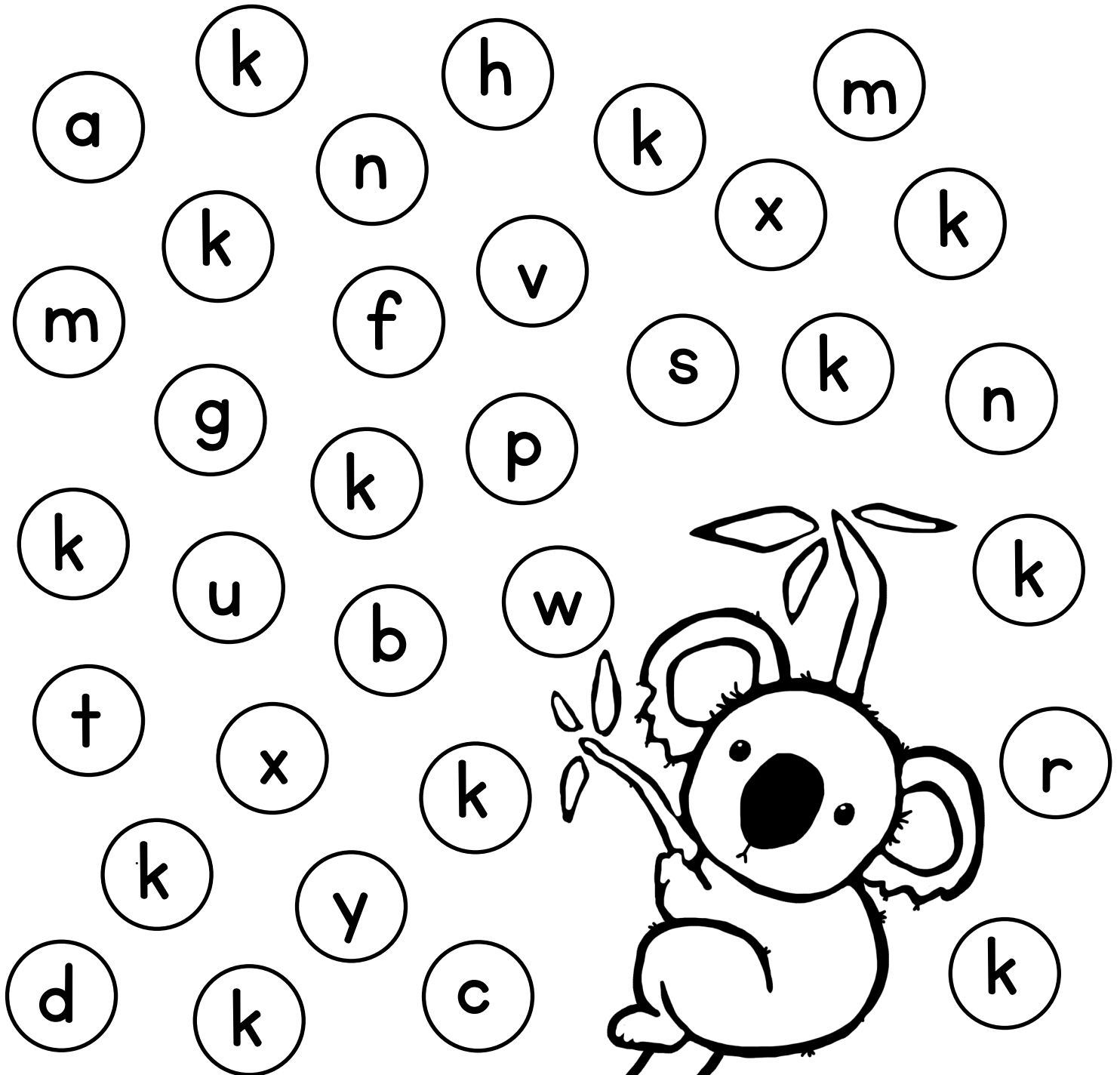

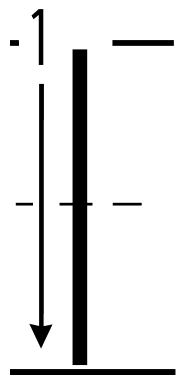

is for
lion

A collection of lowercase letters in circles for a word search. The letters are: l, c, m, g, m, b, l, n, f, d, l, s, q, o, z, r, L, e, k, n, l, t, i, g, j, l, h, l, l.



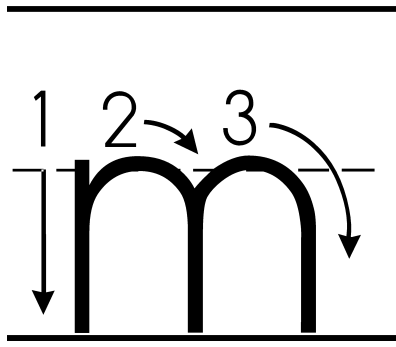

is for
mushroom

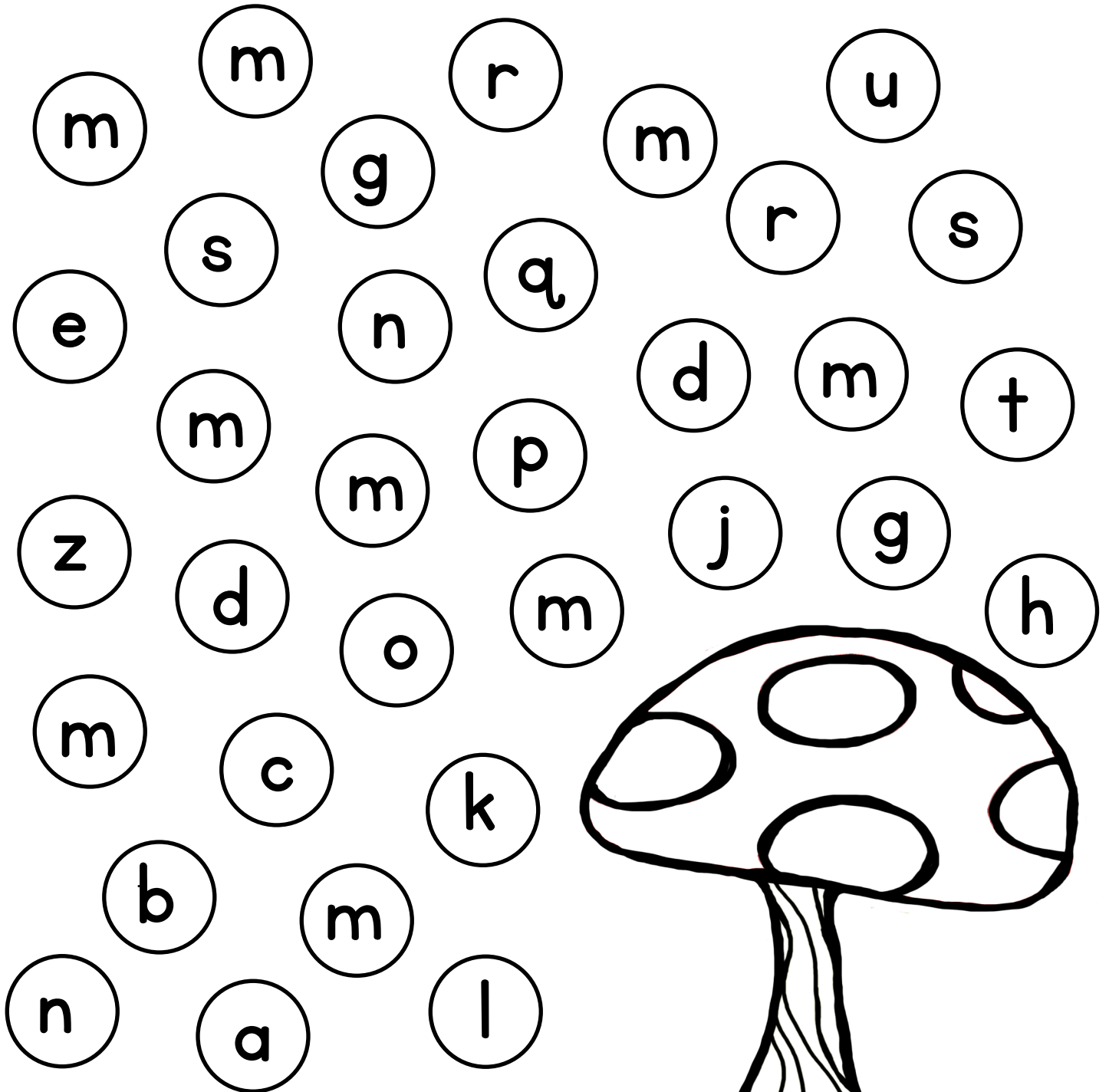

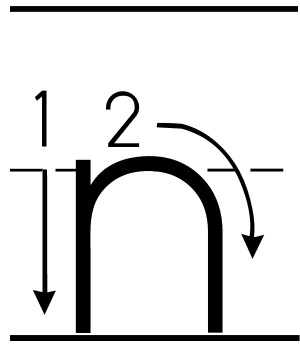

is for
nest

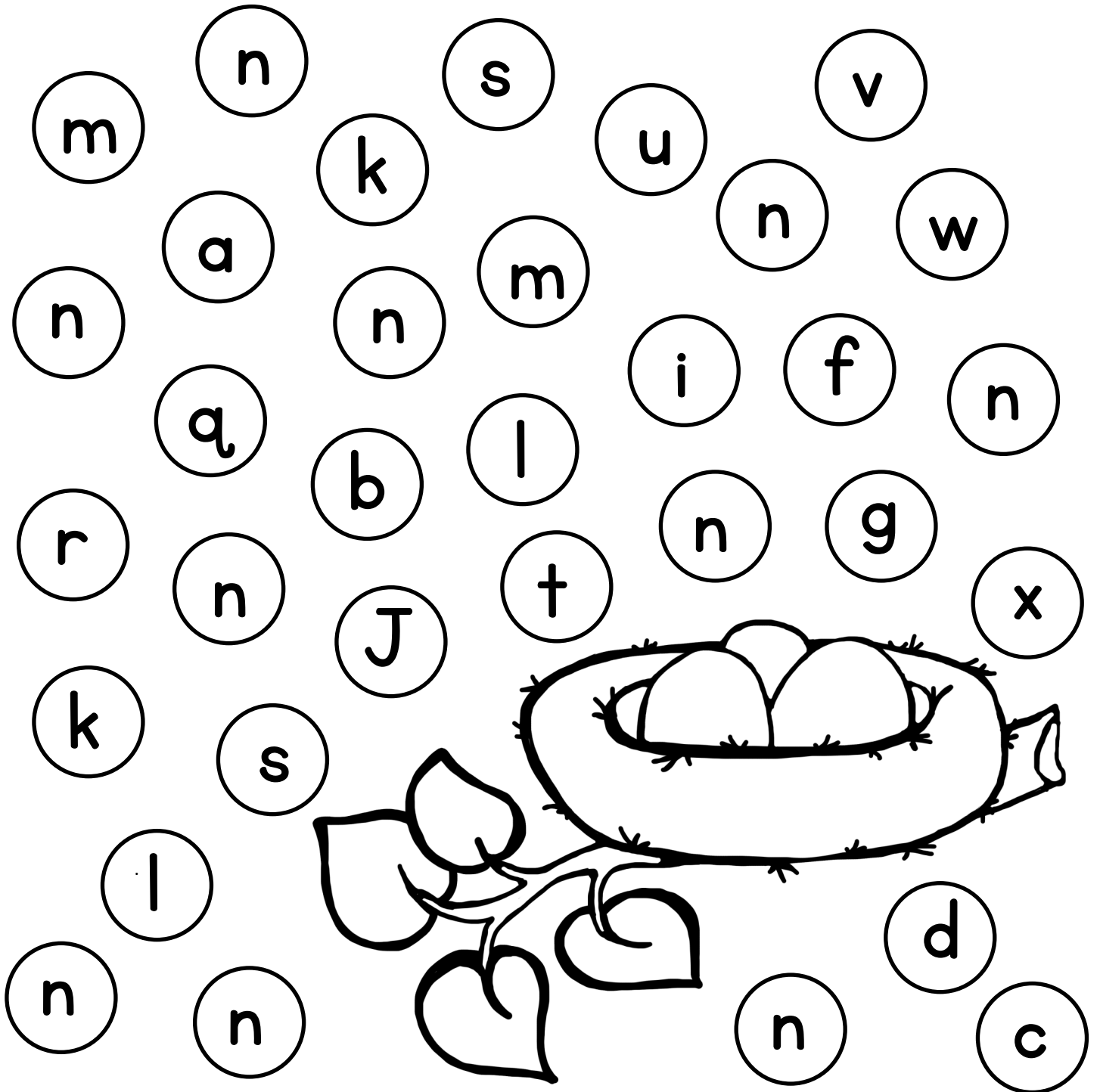

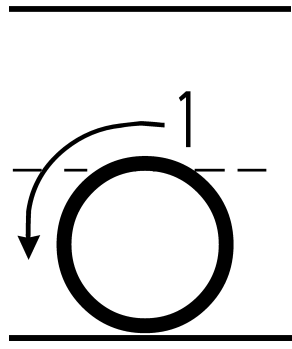

is for
octopus

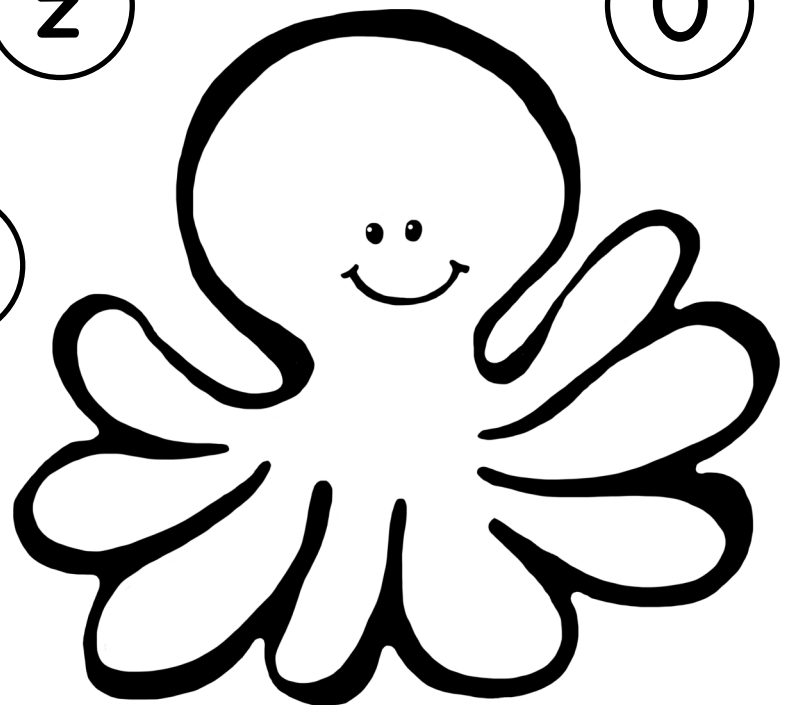
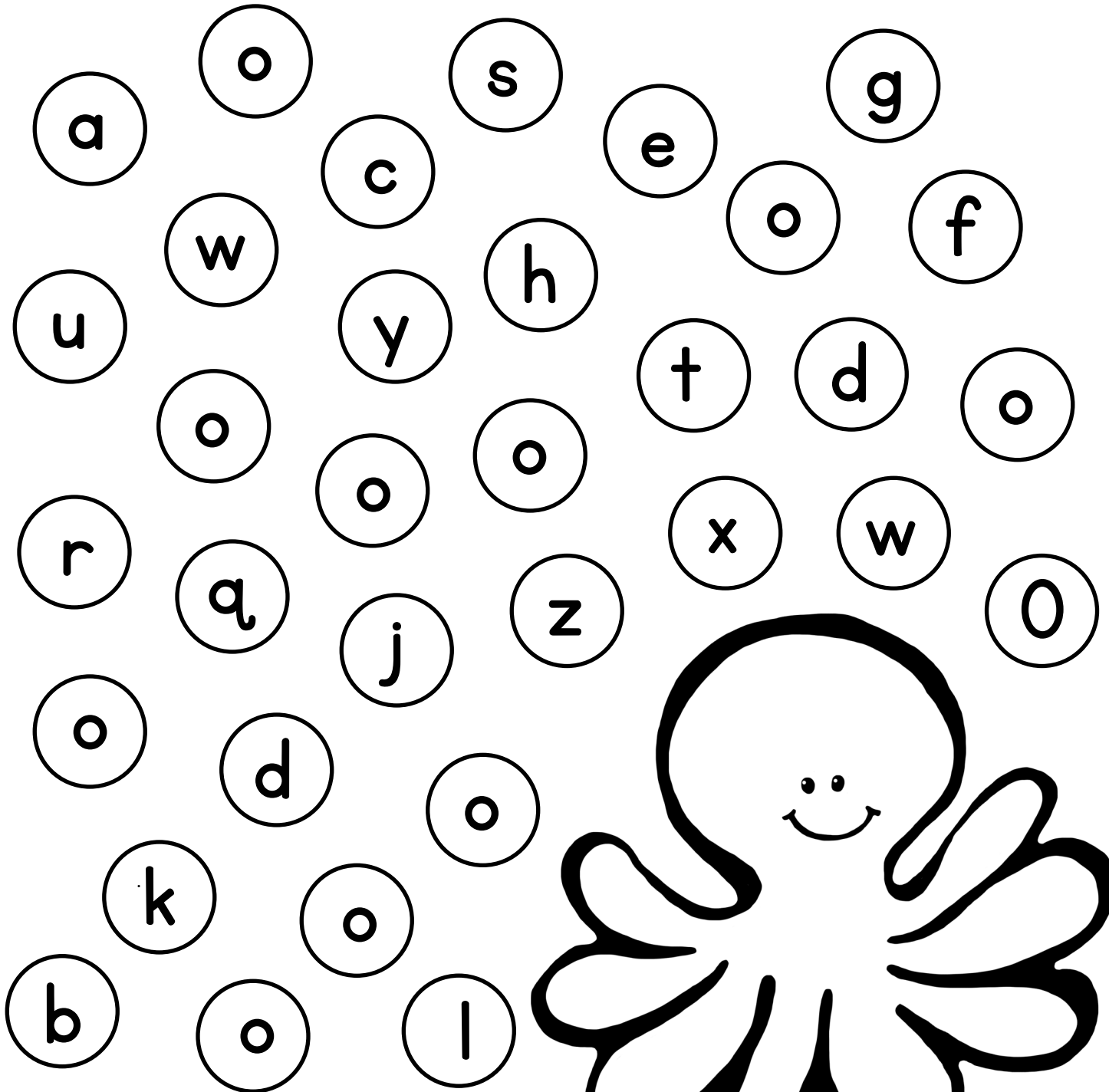

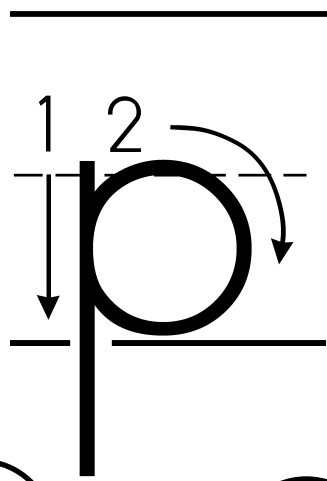

is for
pig

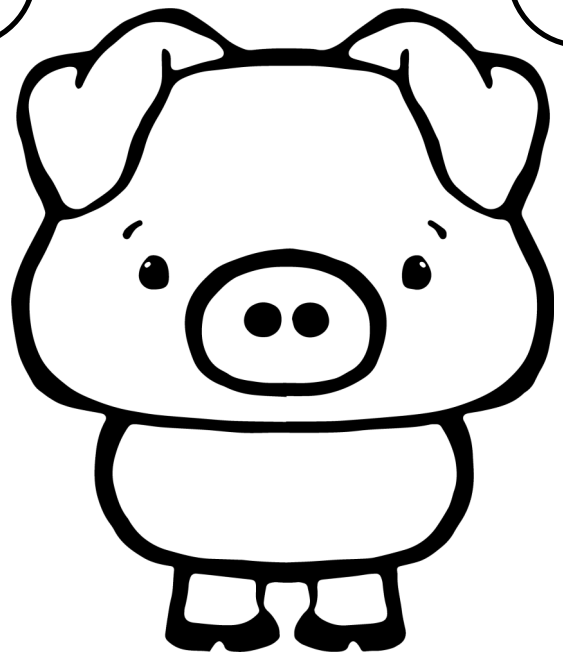
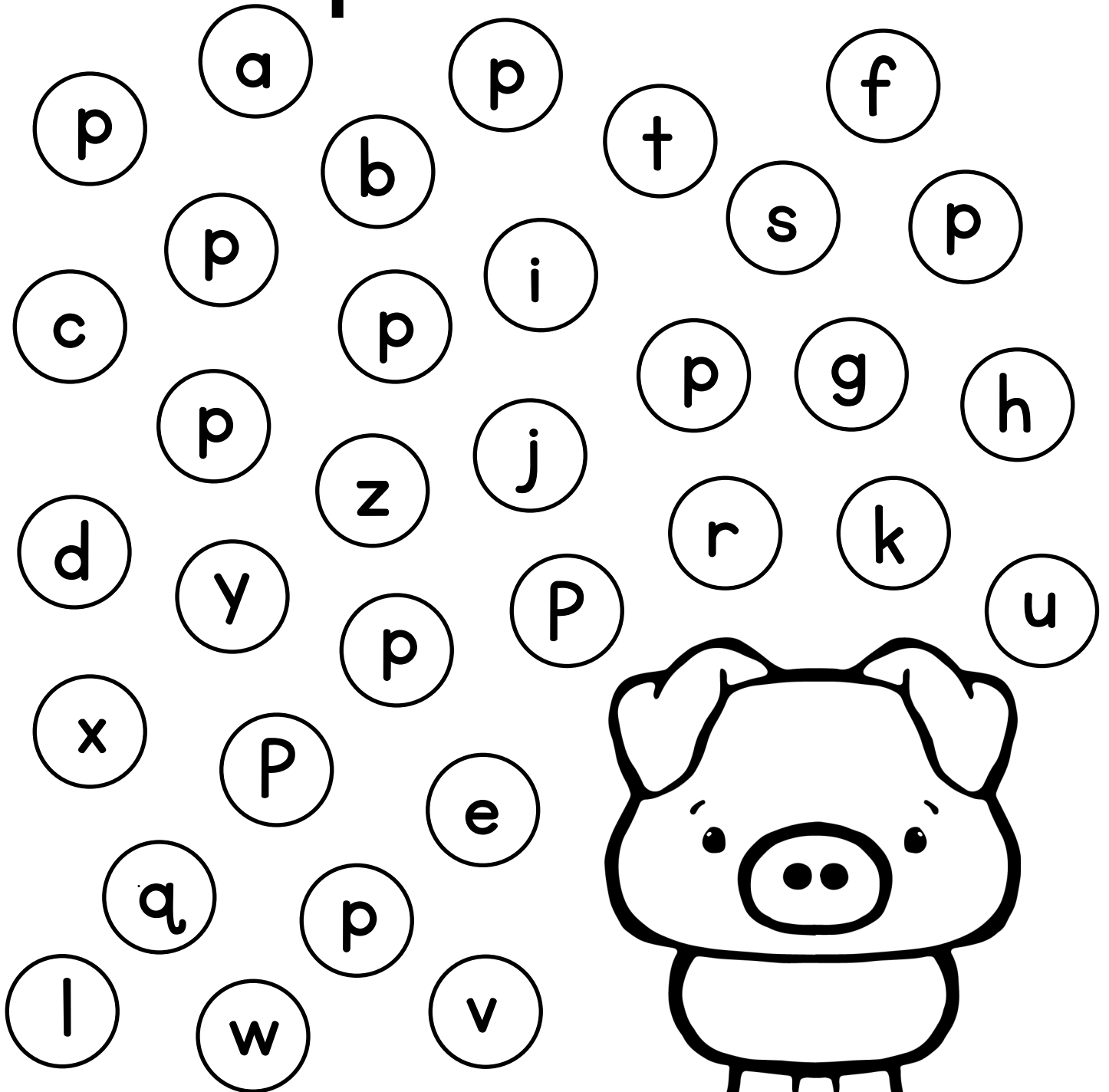

is for
queen

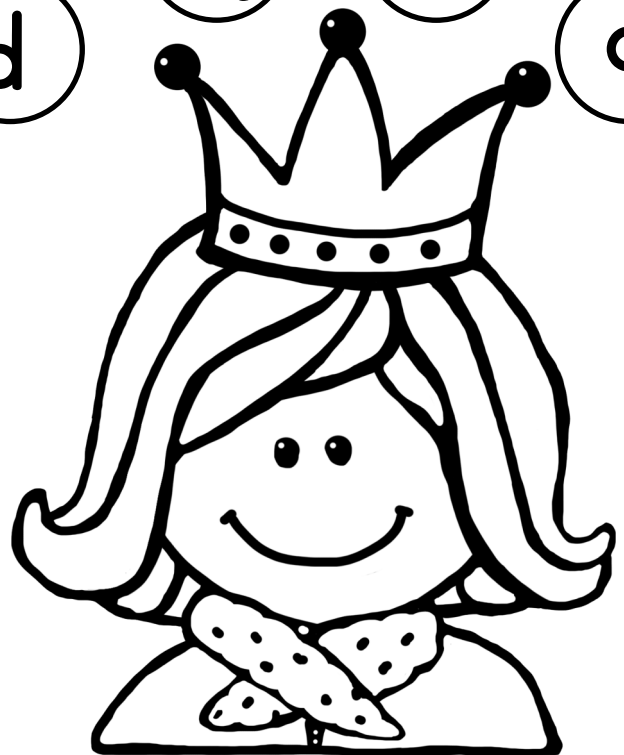
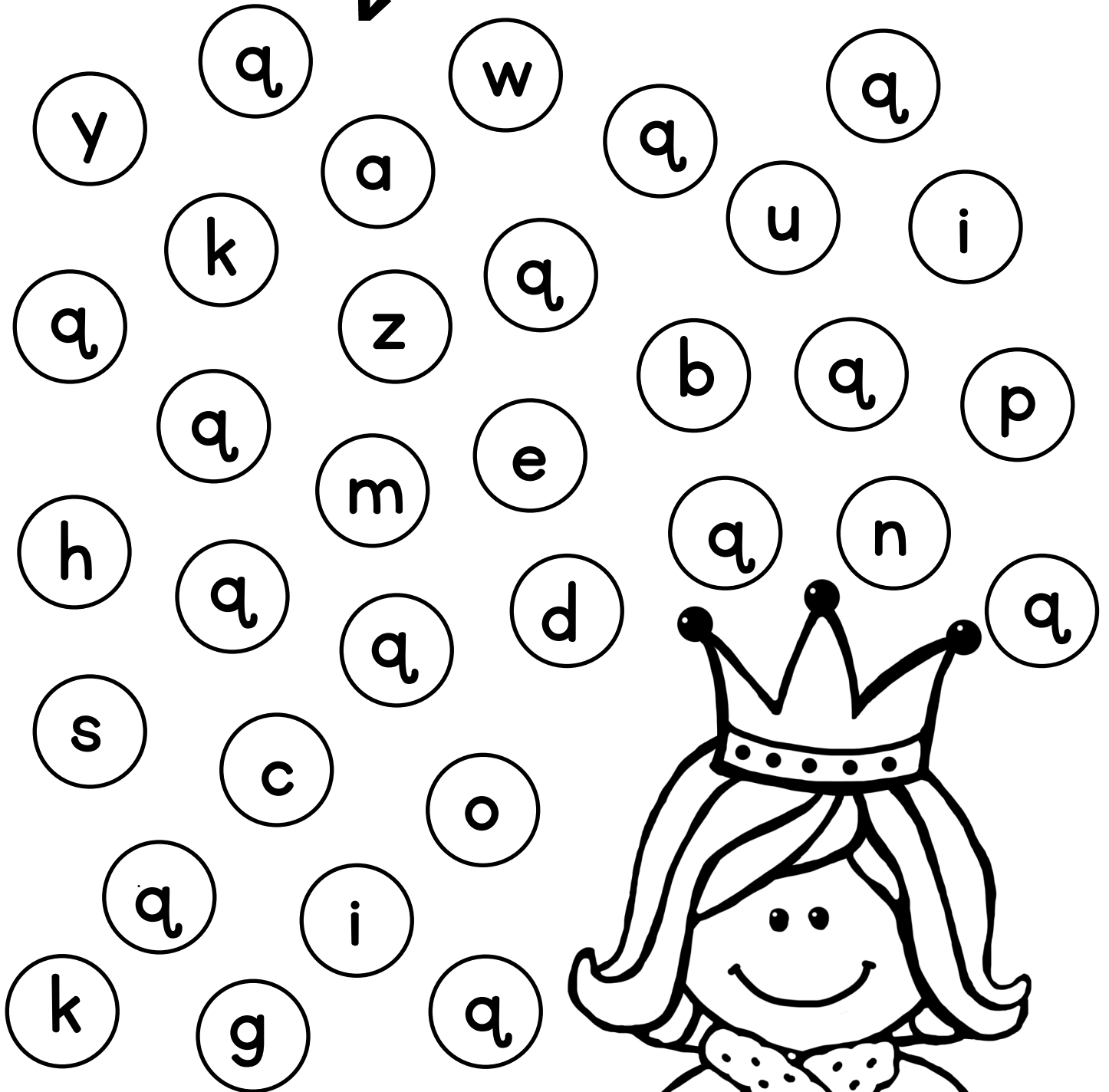
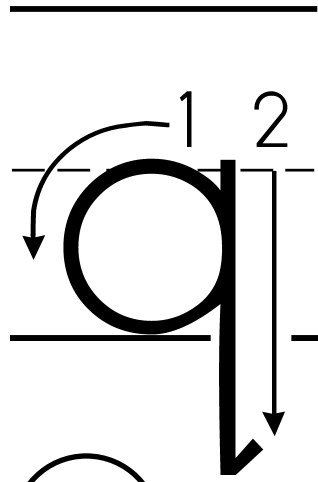

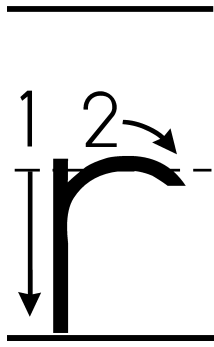

is for
rabbit

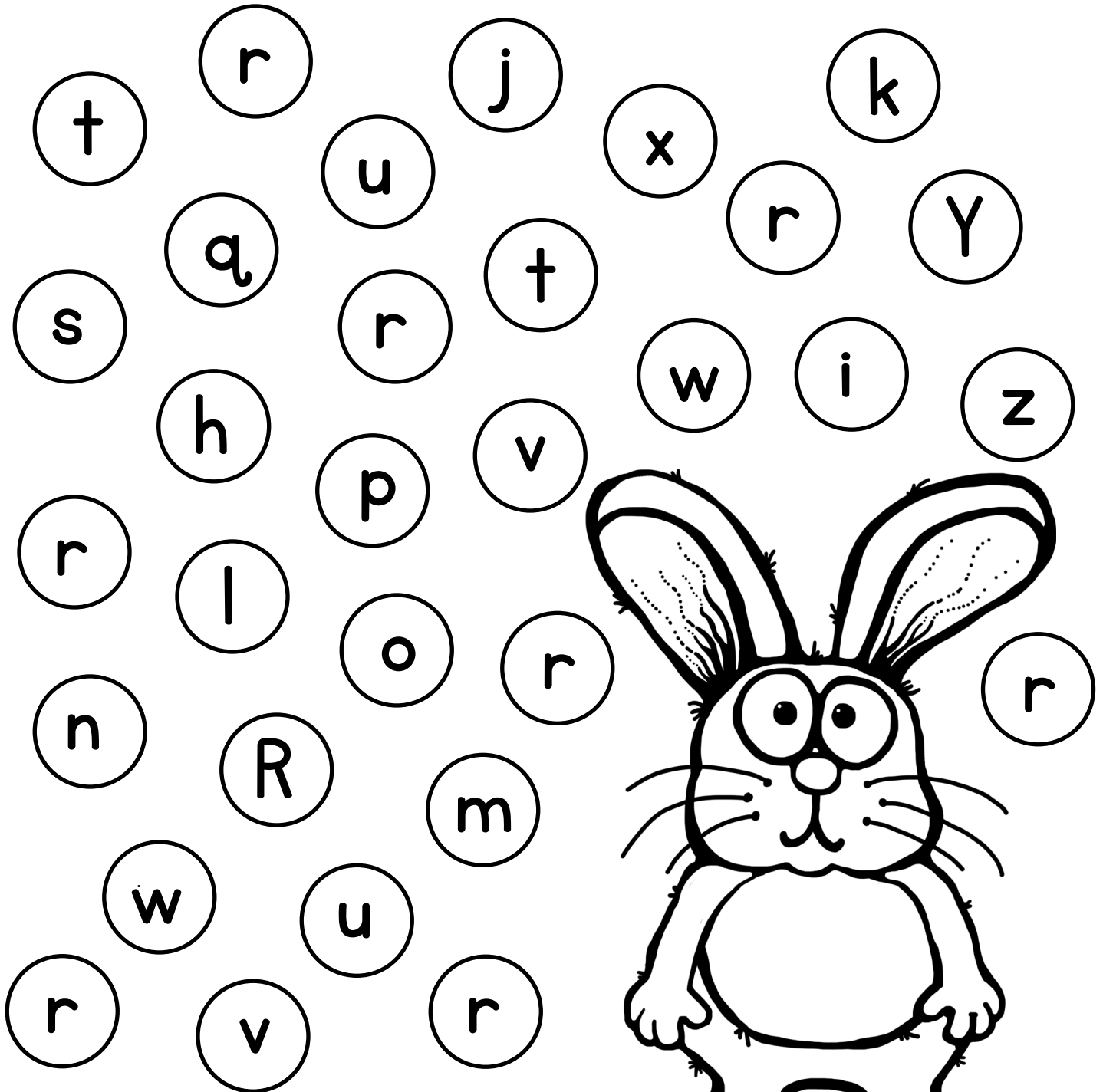

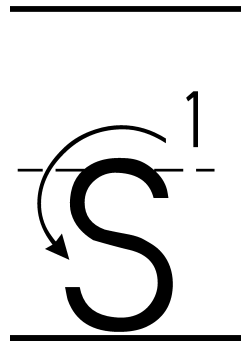

is for
snake

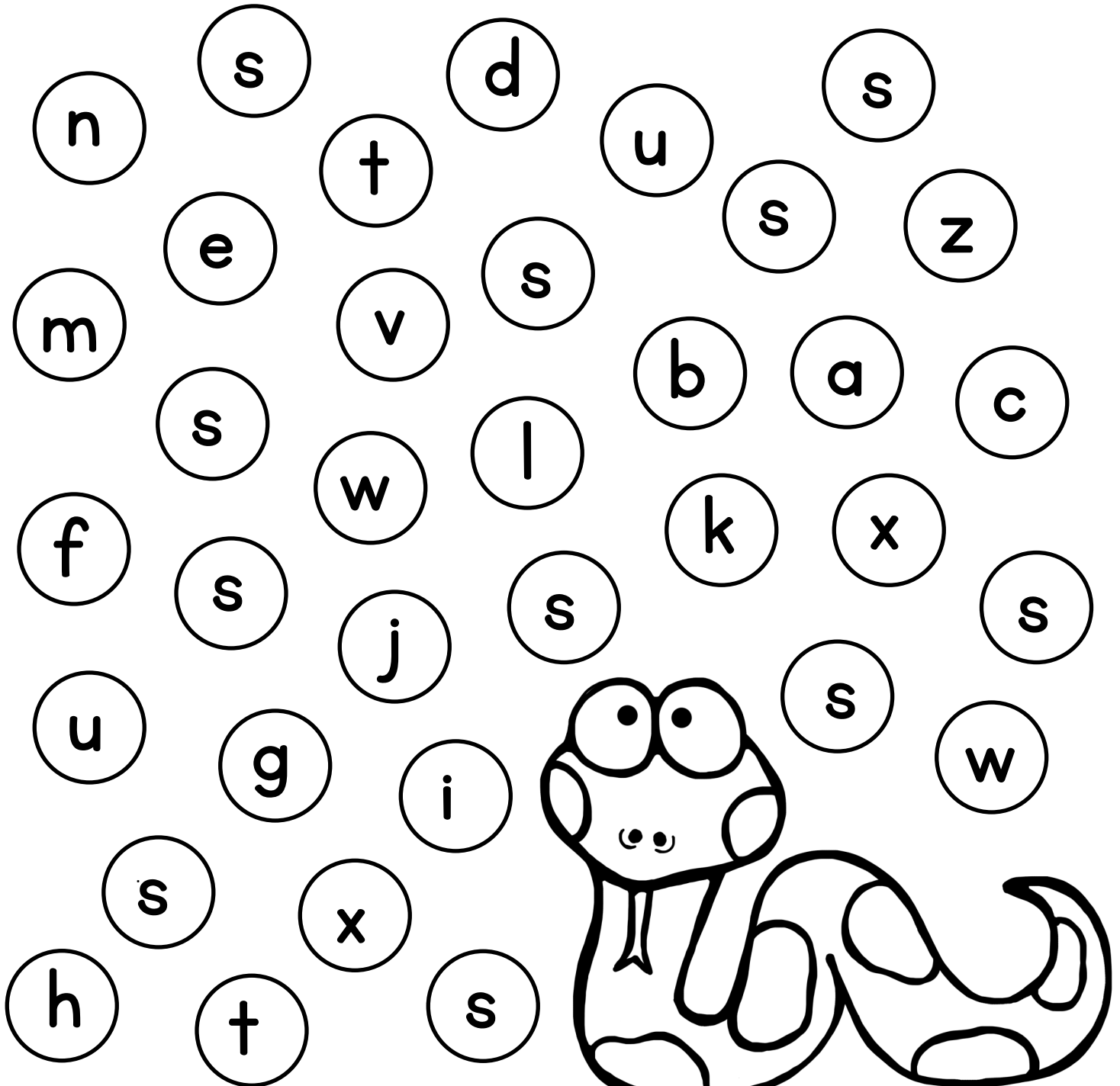

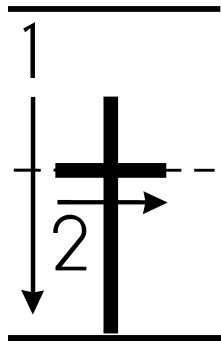

is for
turtle

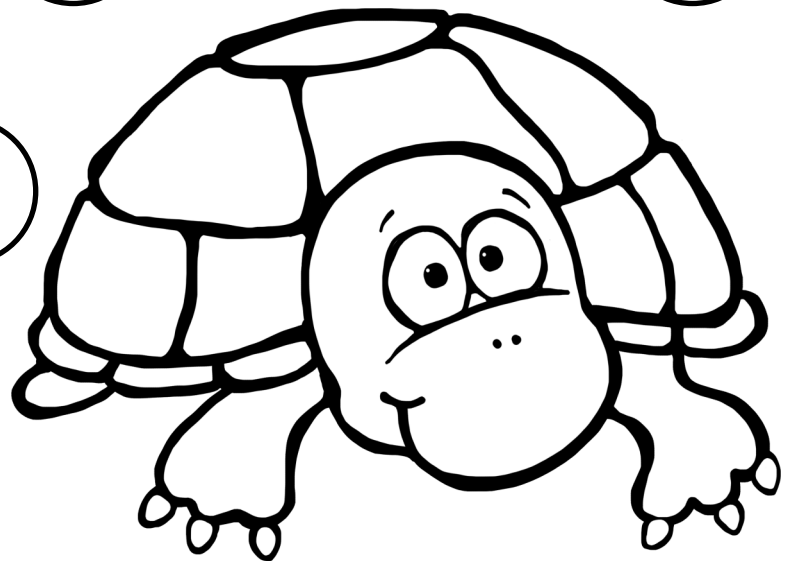
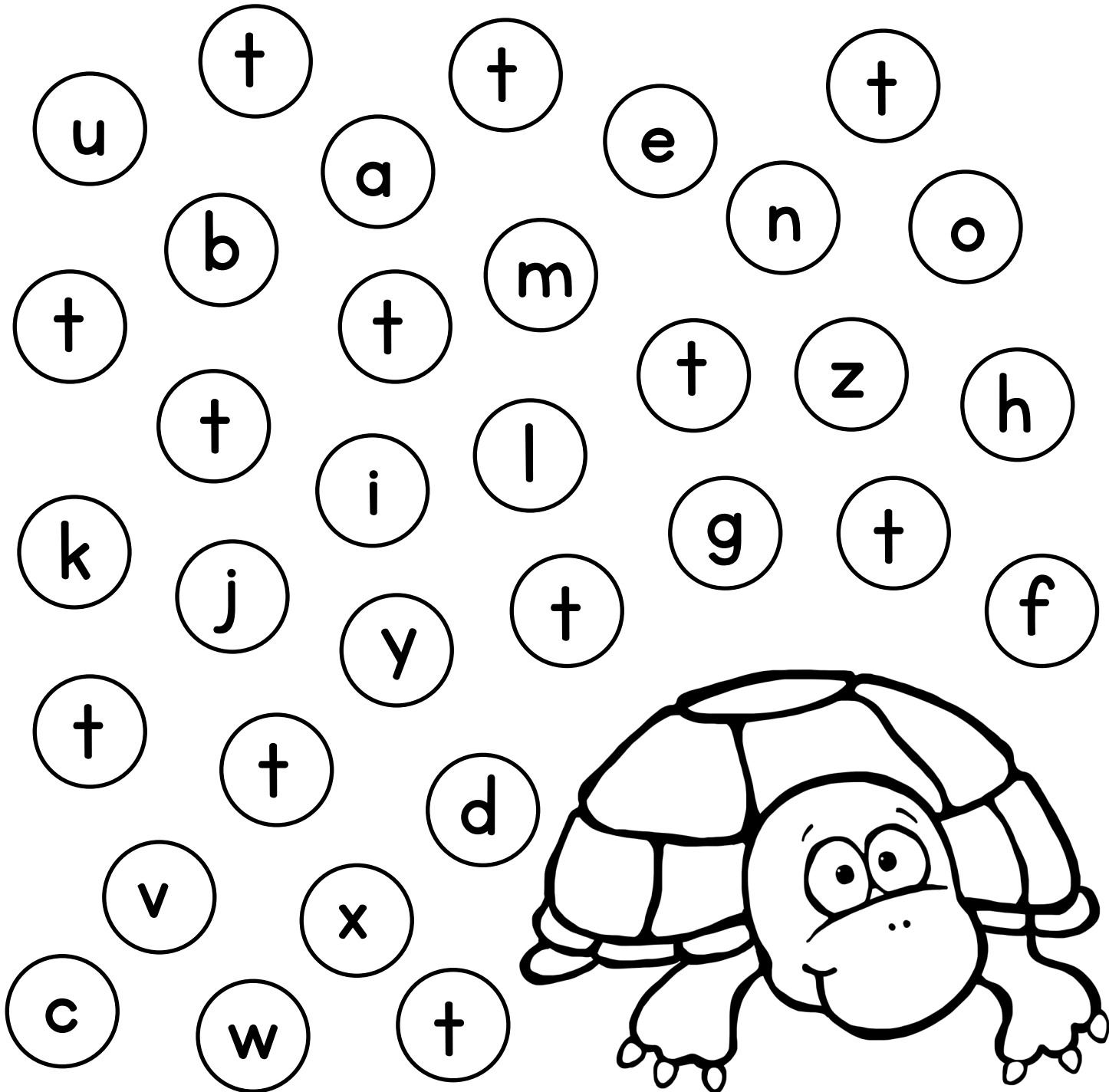

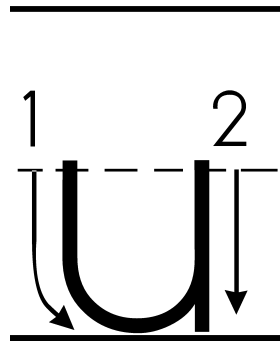

is for
umbrella

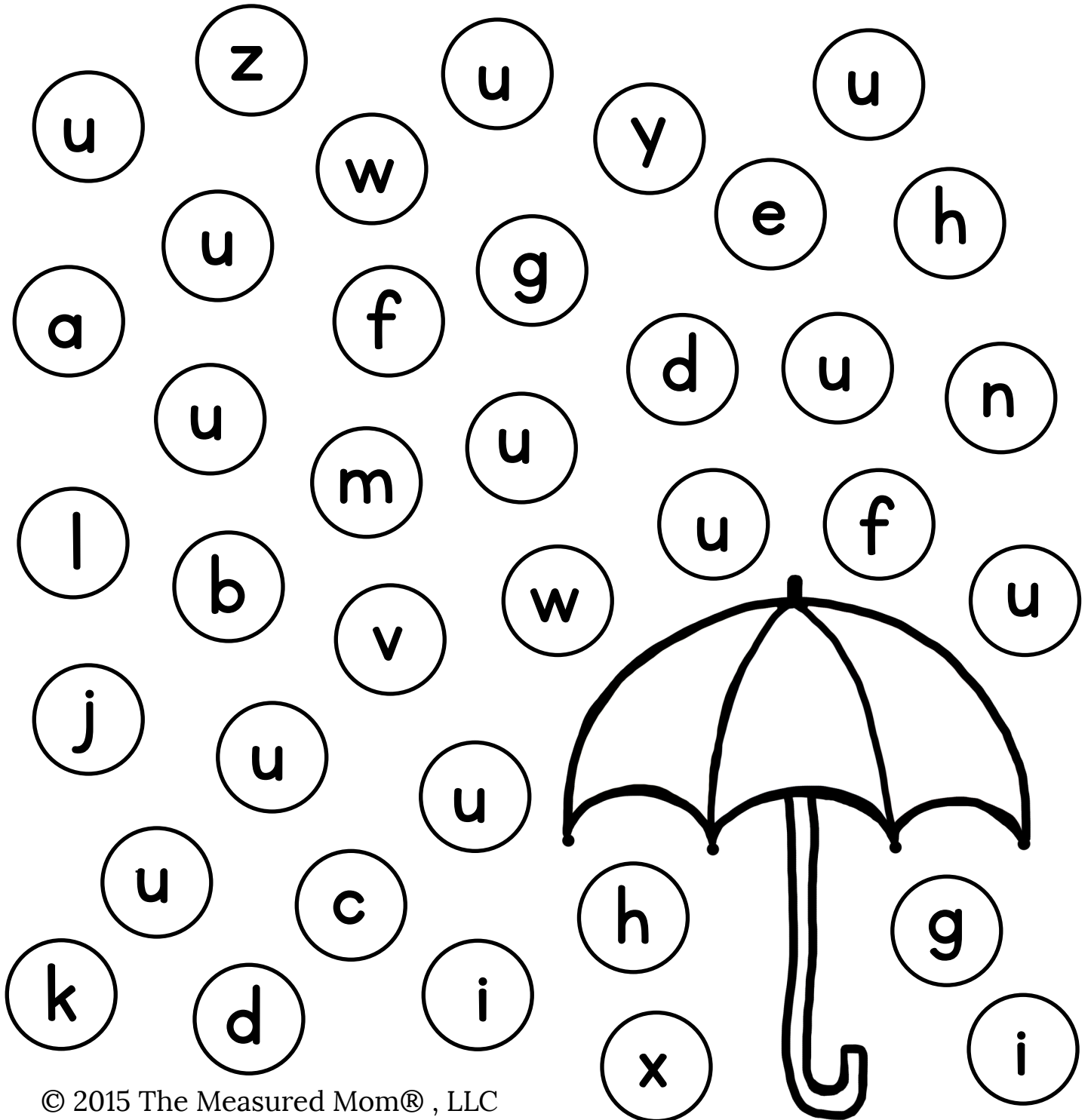

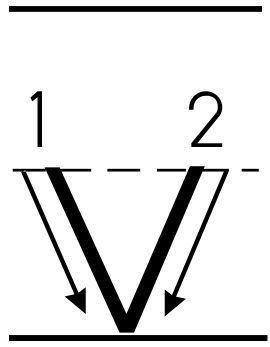

is for
volcano

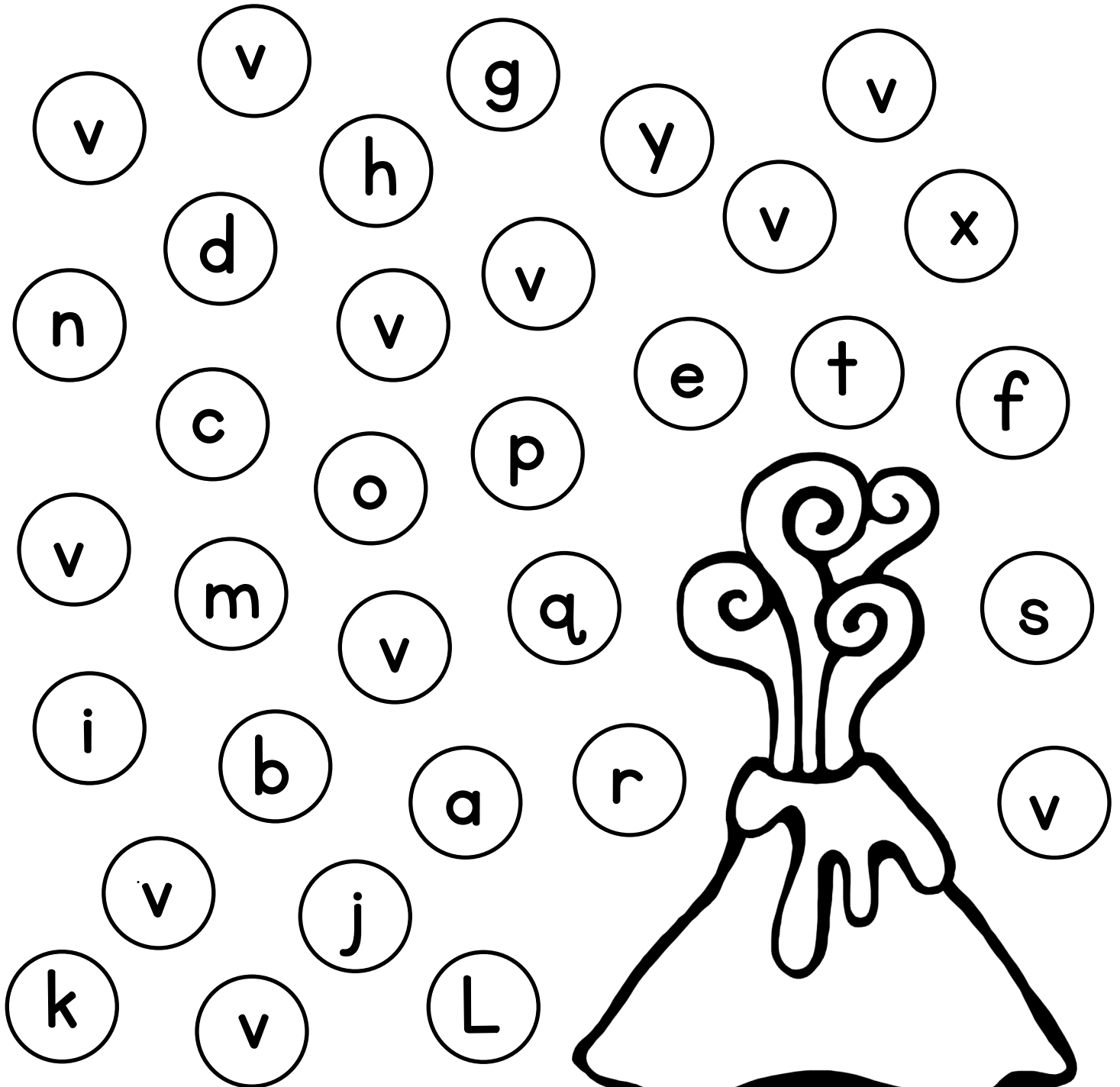

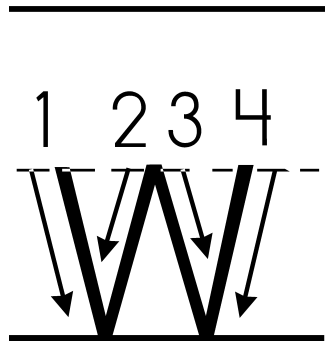

is for
whale

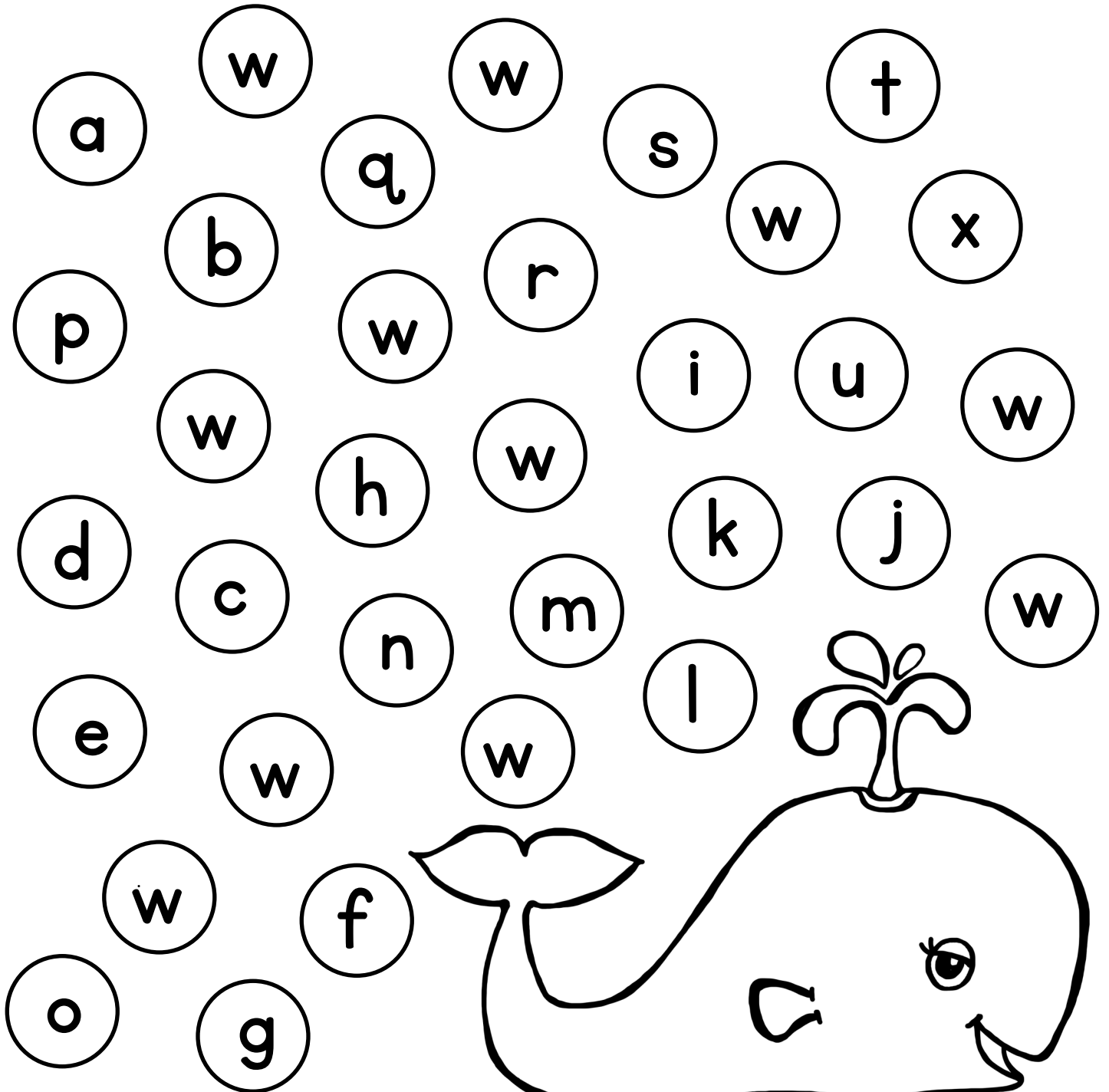

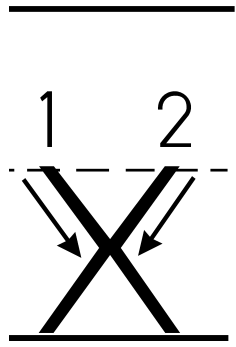

is for
X-ray

A collection of letters in circles for a word search. The letters are: x, x, m, X, y, i, n, s, e, t, x, k, r, f, u, x, y, j, h, x, y, z, v, o, l, x, y, p, q, x, g.

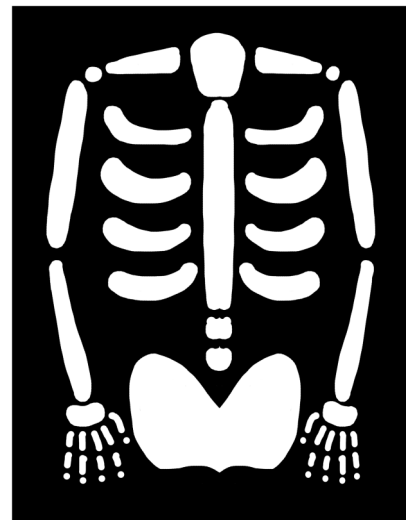

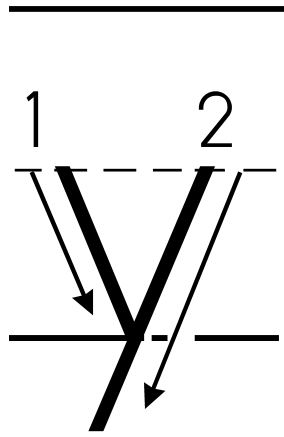

is for
yarn

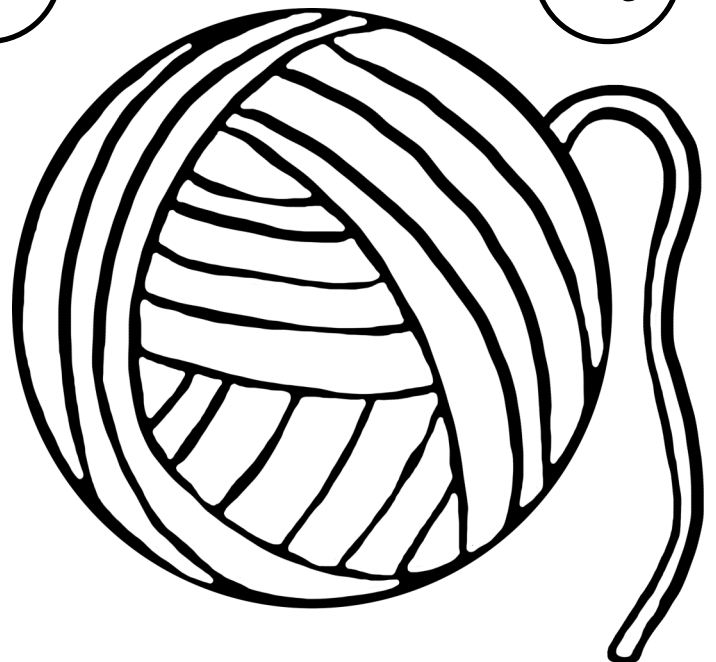
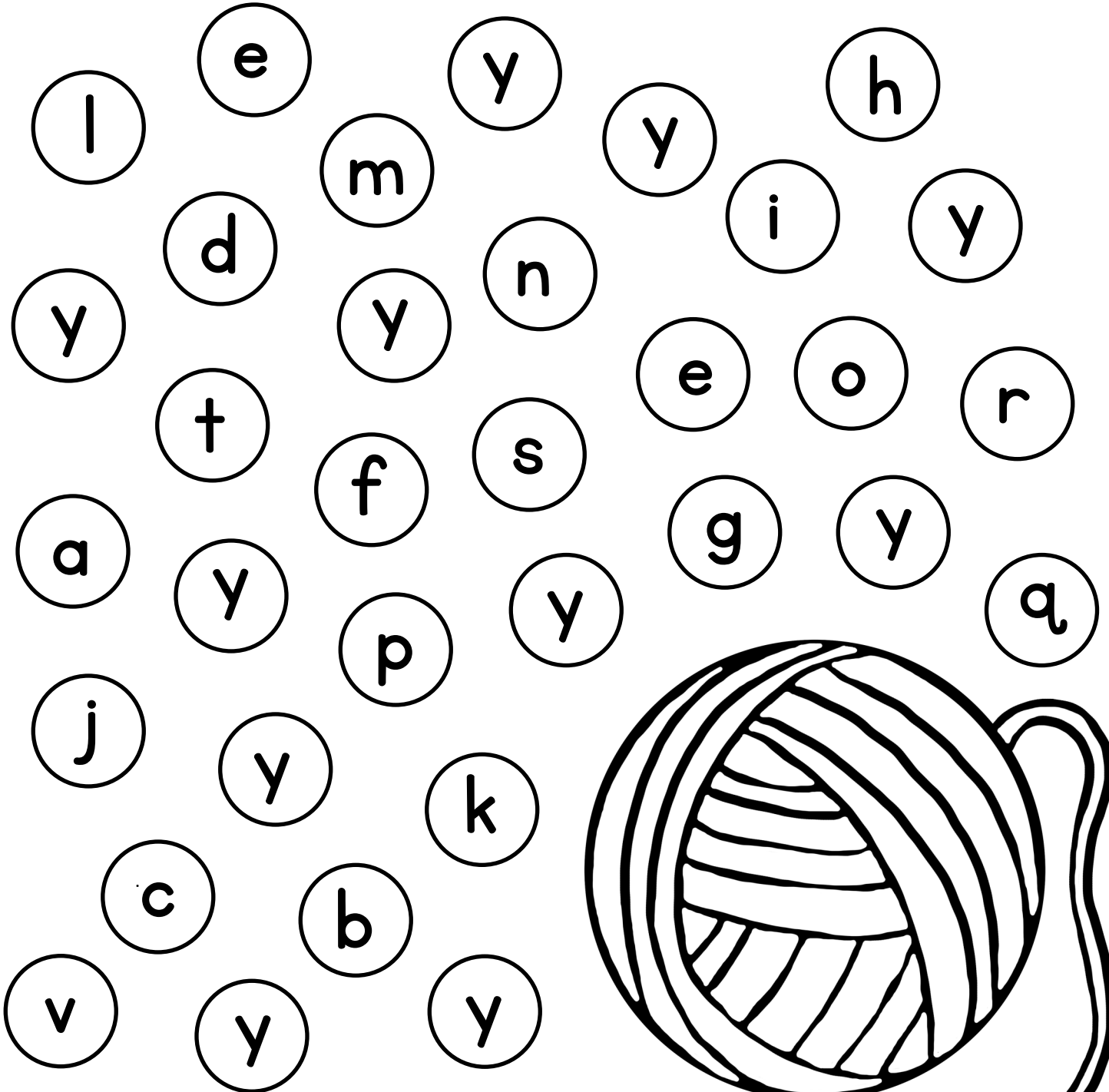

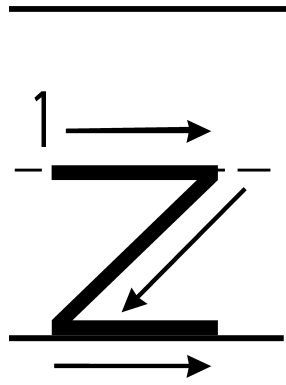

is for
zebra

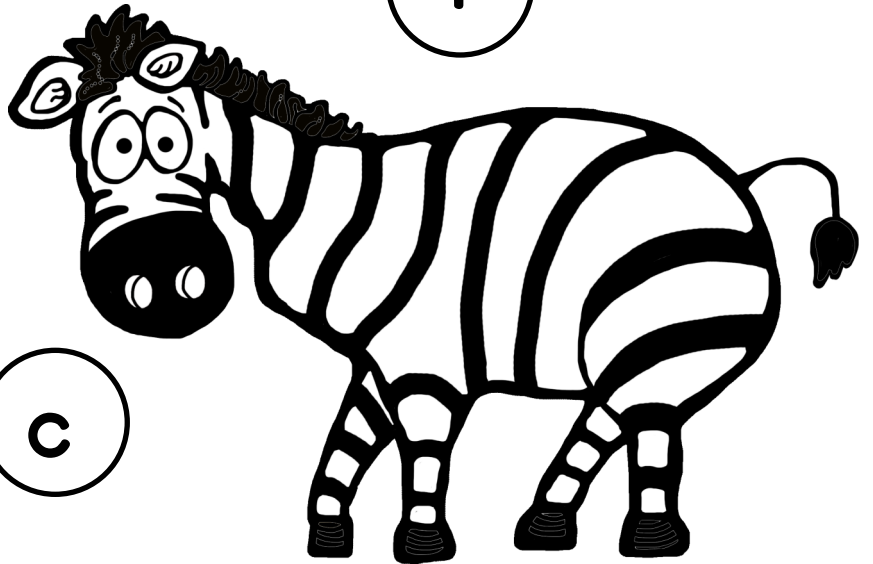
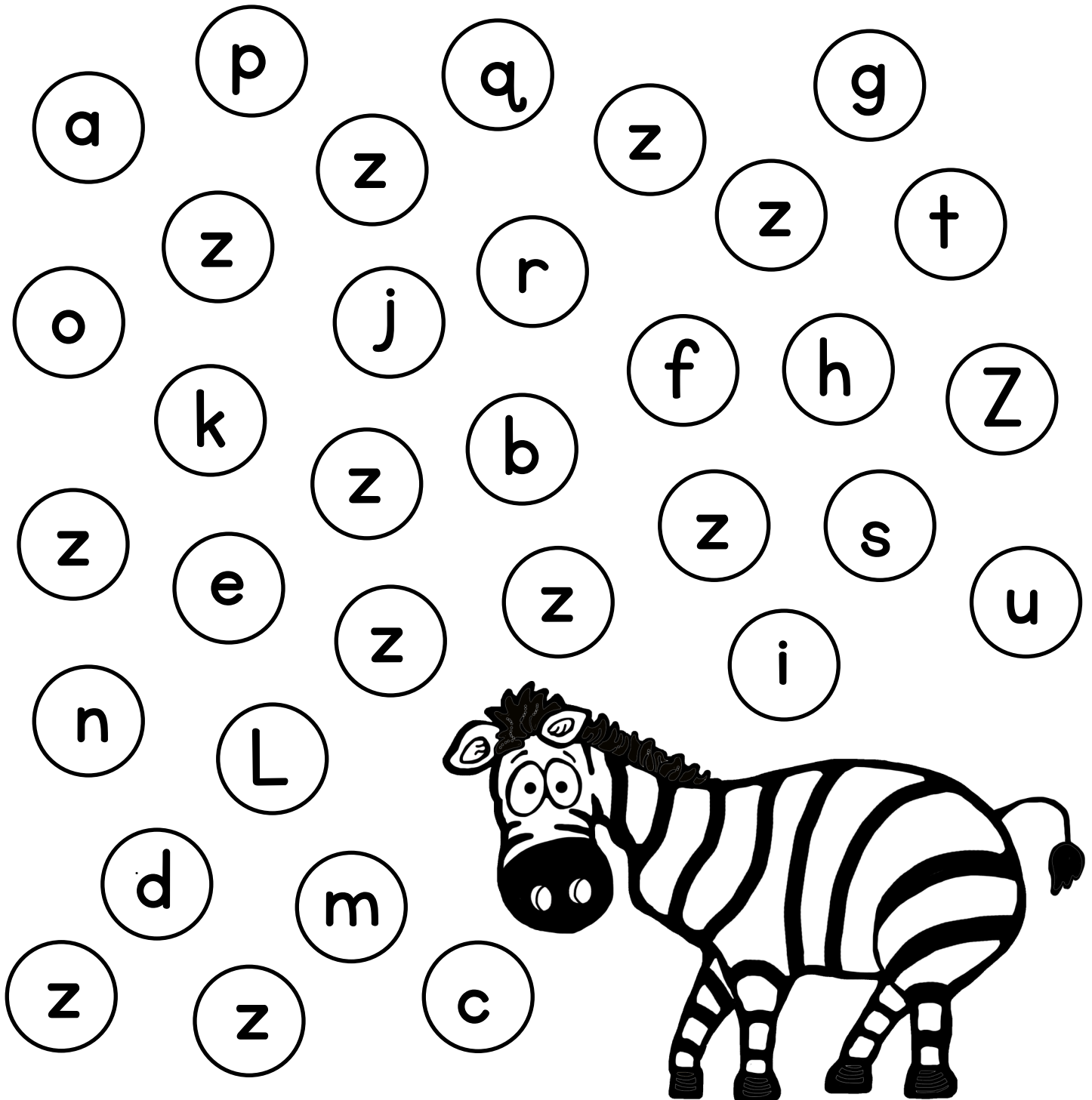

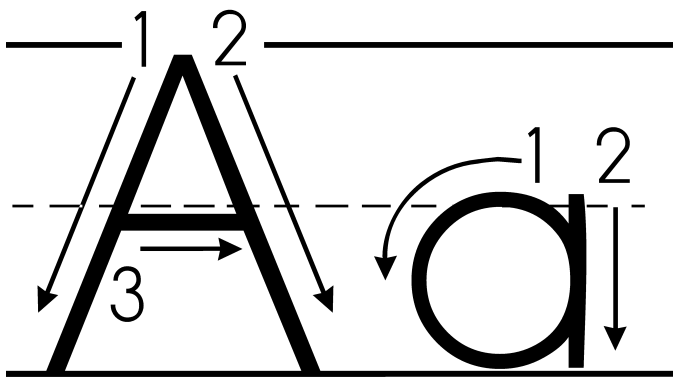

is for
apple

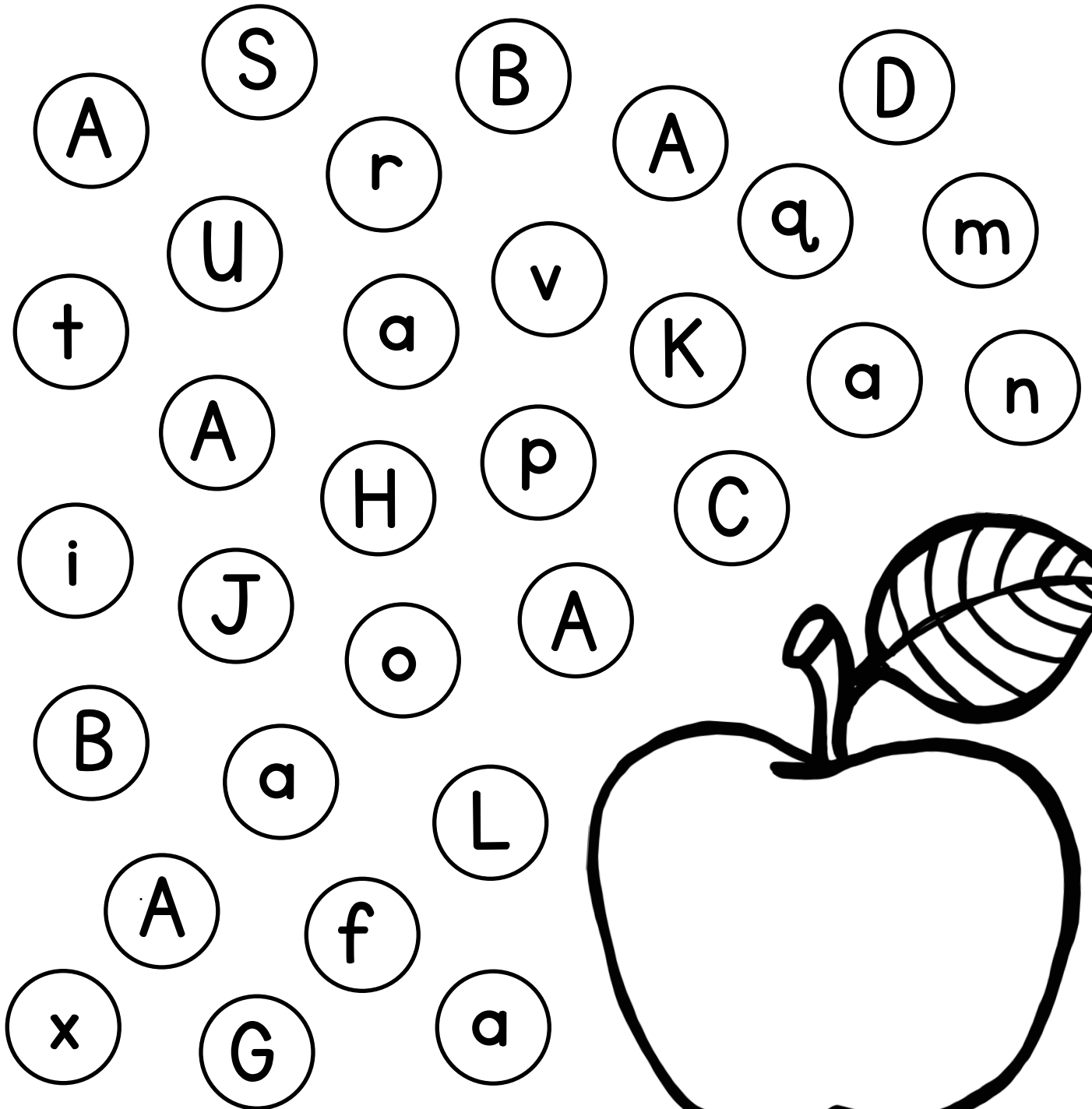

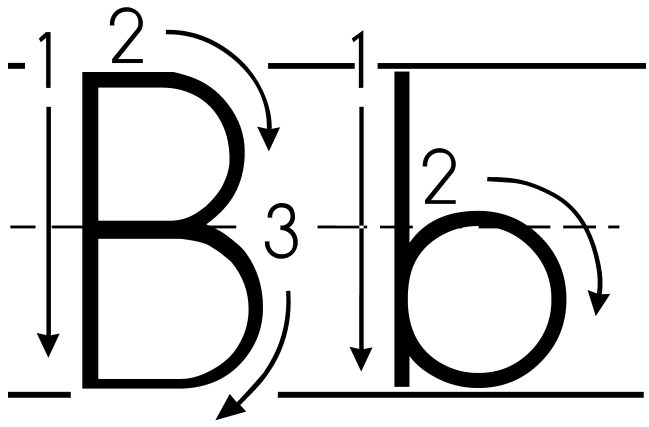

is for
bird

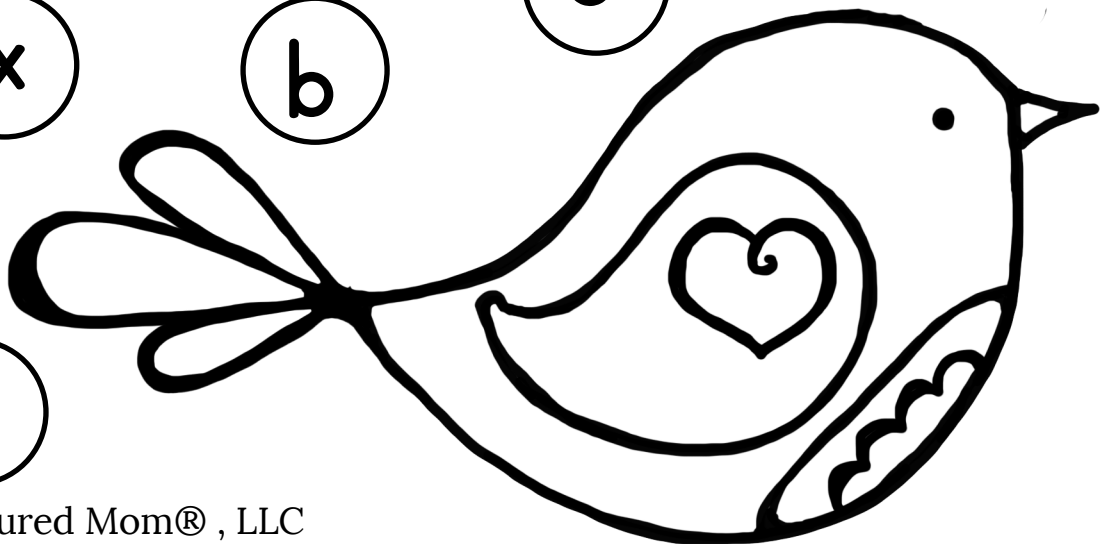
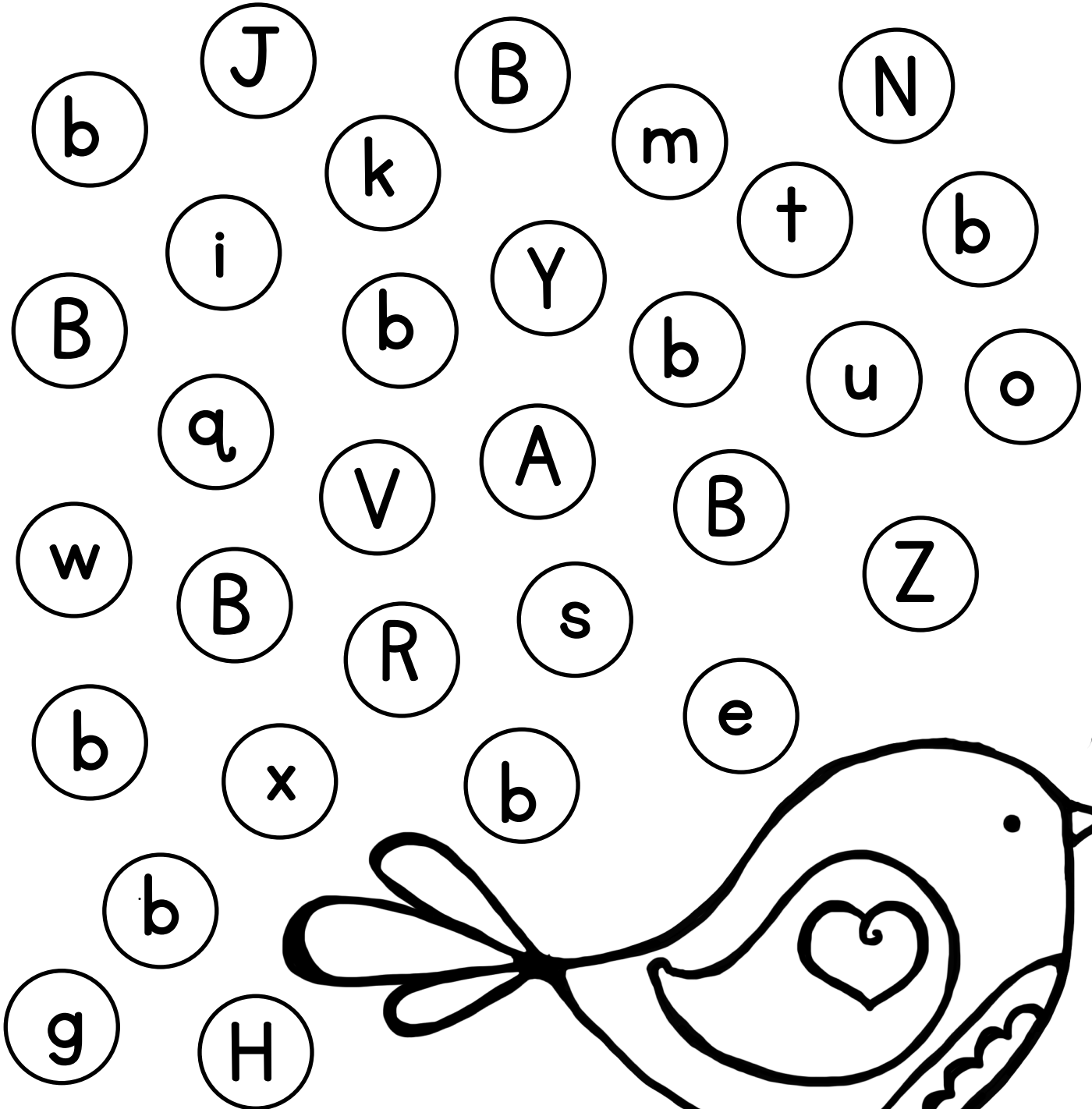

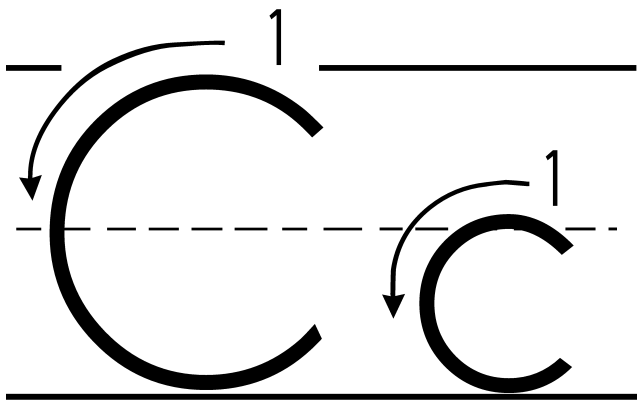

is for
cat

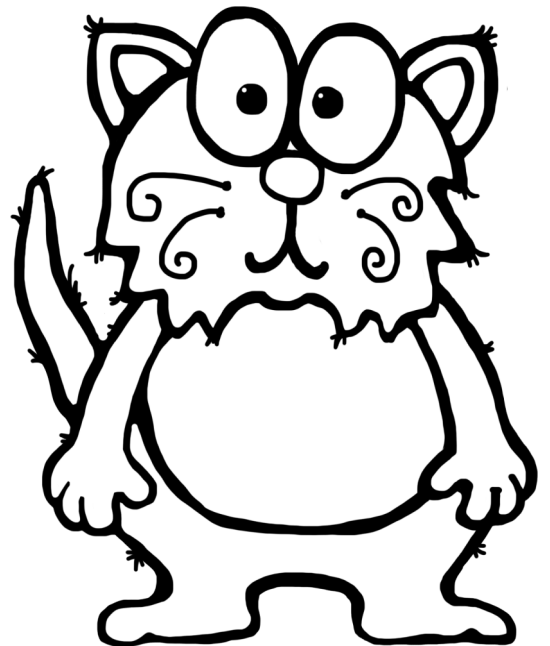
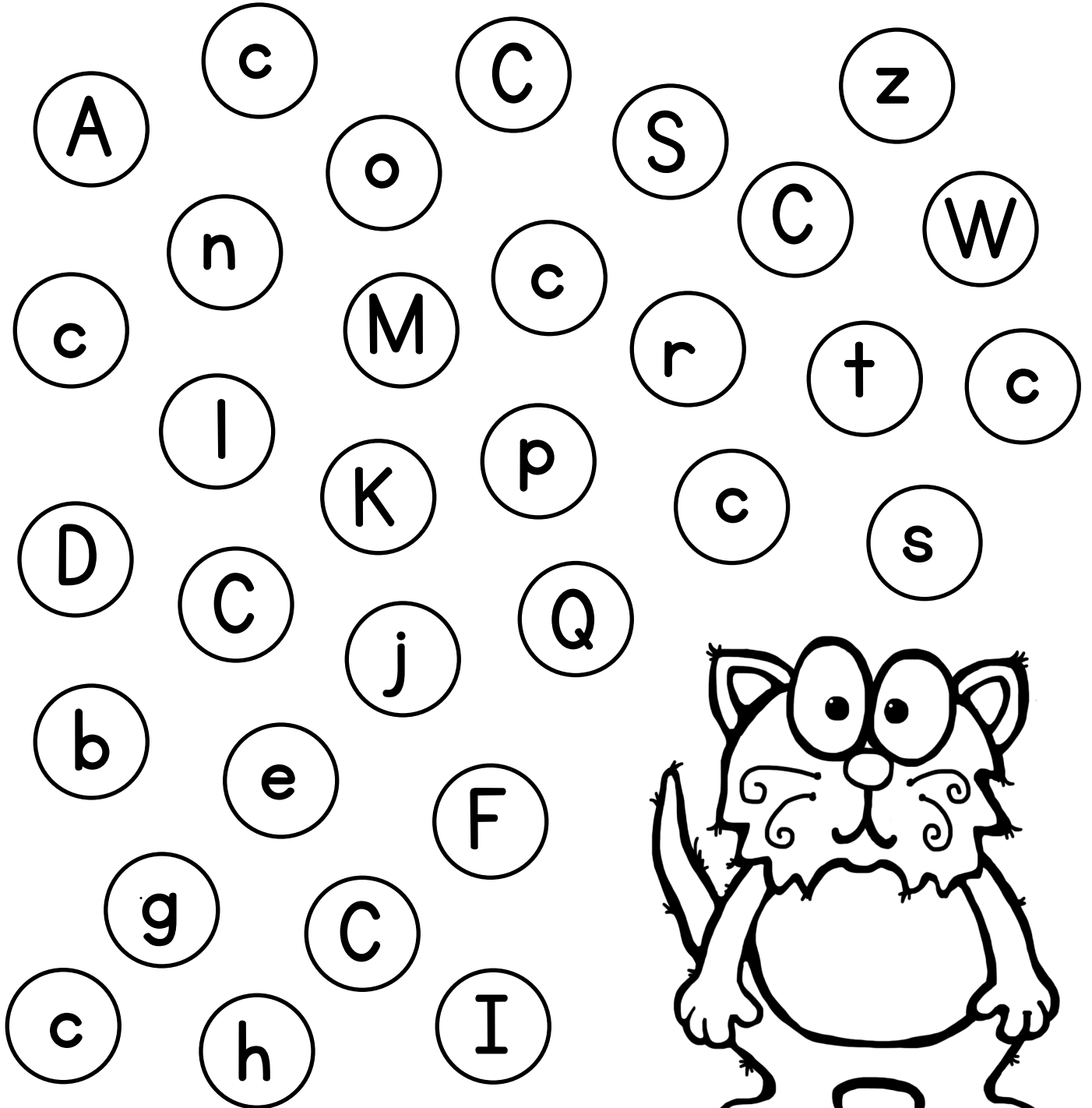

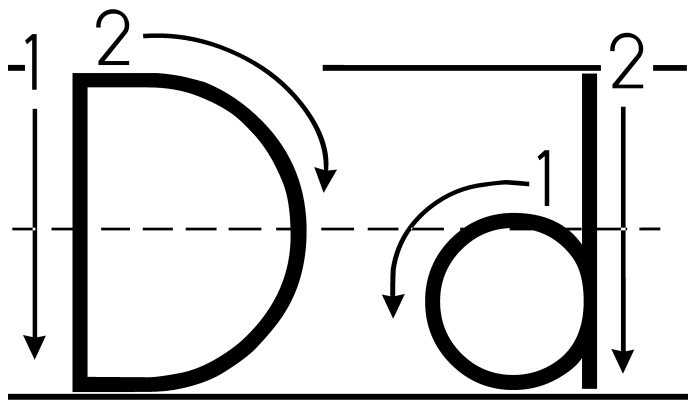

is for
dinosaur

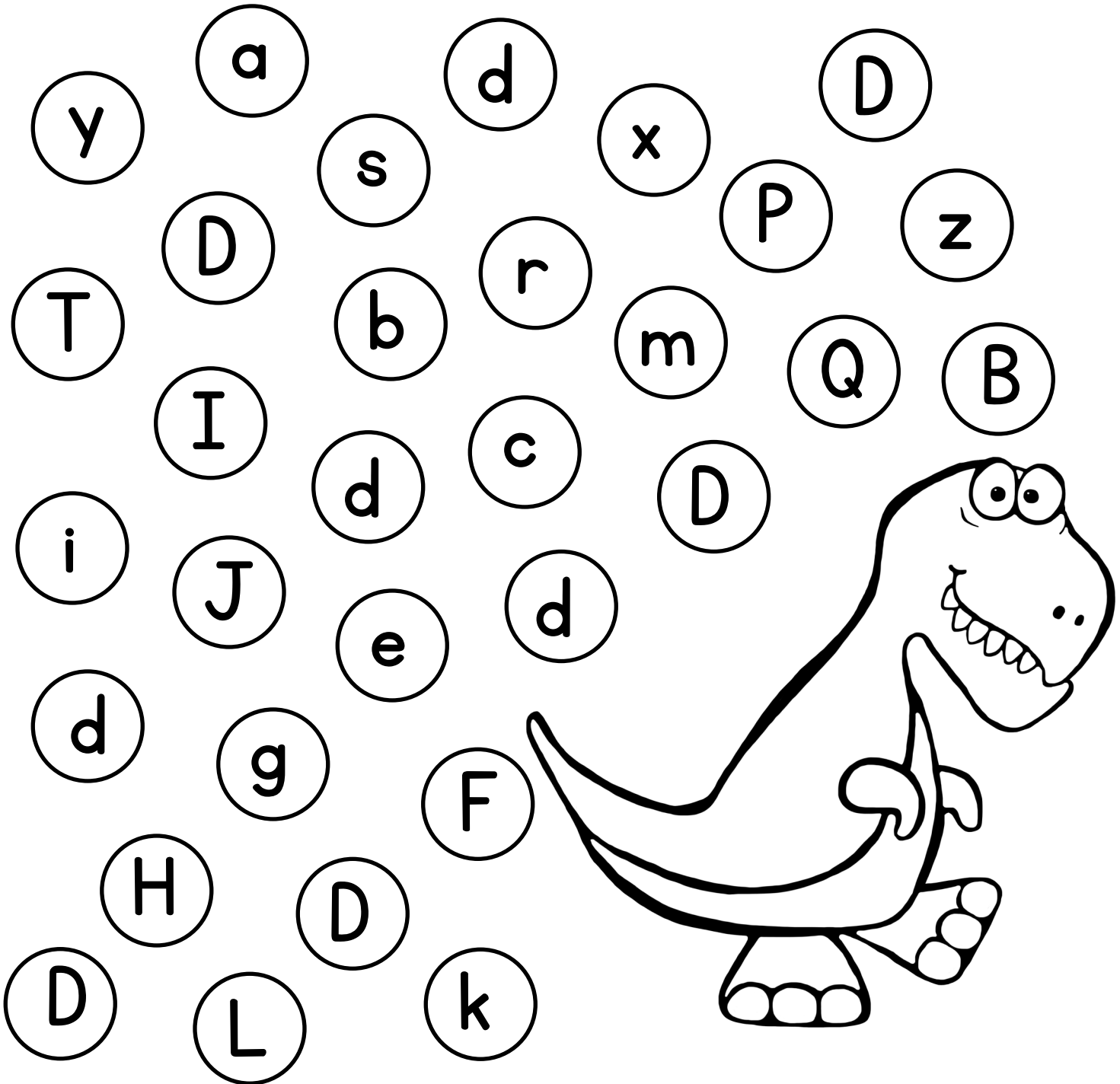

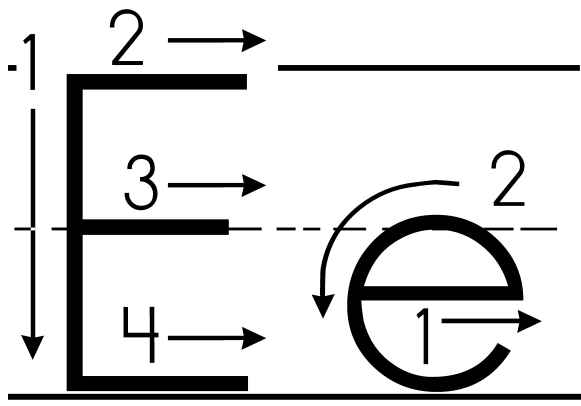

is for
elephant

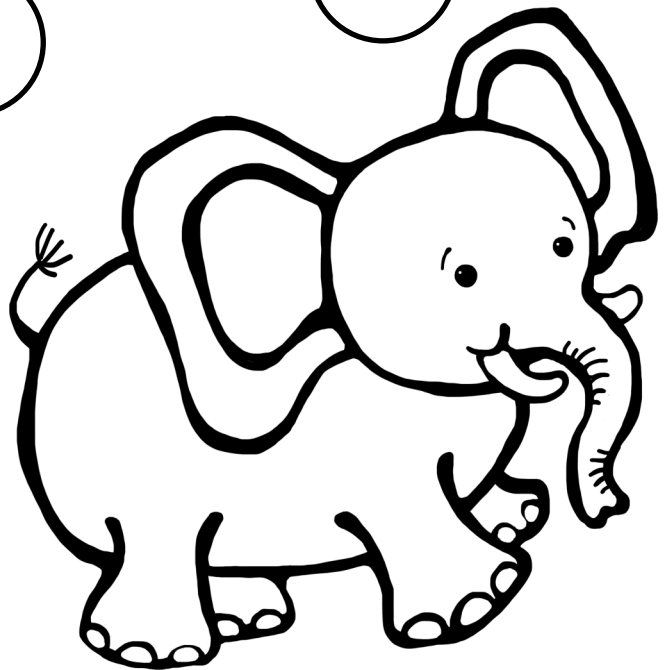
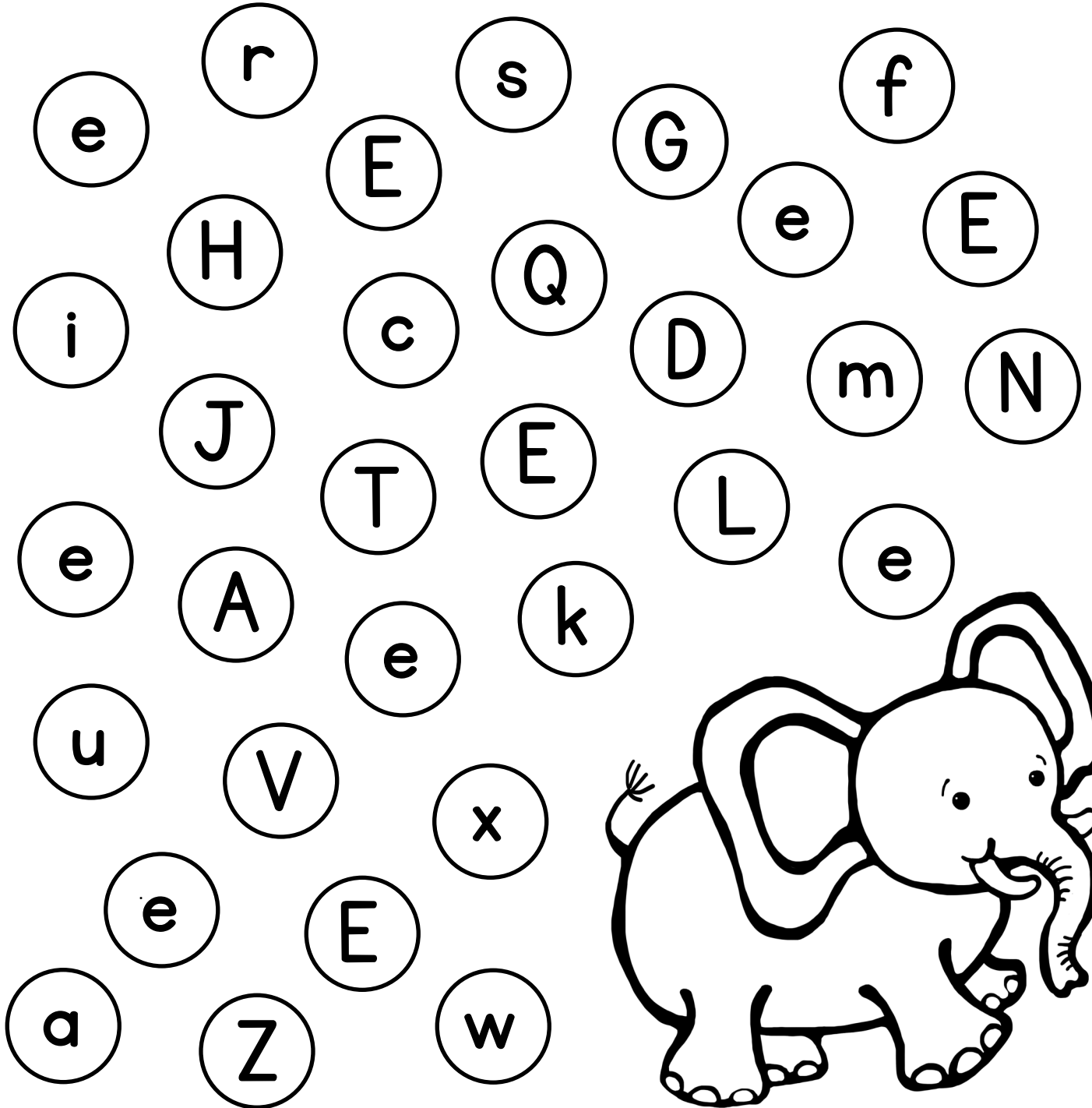

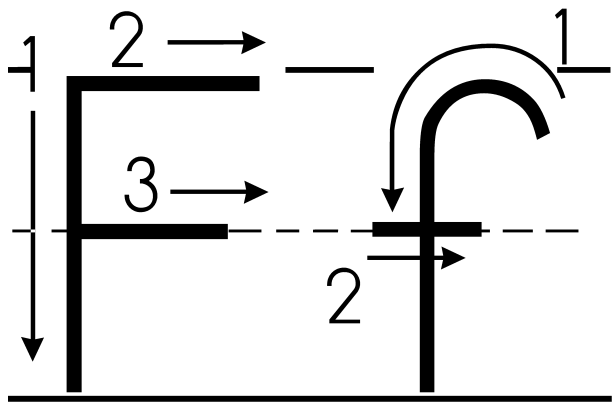

is for
frog

A collection of letters in circles for a dot-marker activity. The letters are: A, F, u, L, G, T, s, E, f, j, F, V, d, w, r, P, f, F, h, F, f, C, Q, F, x, b, Y, f, z, f.

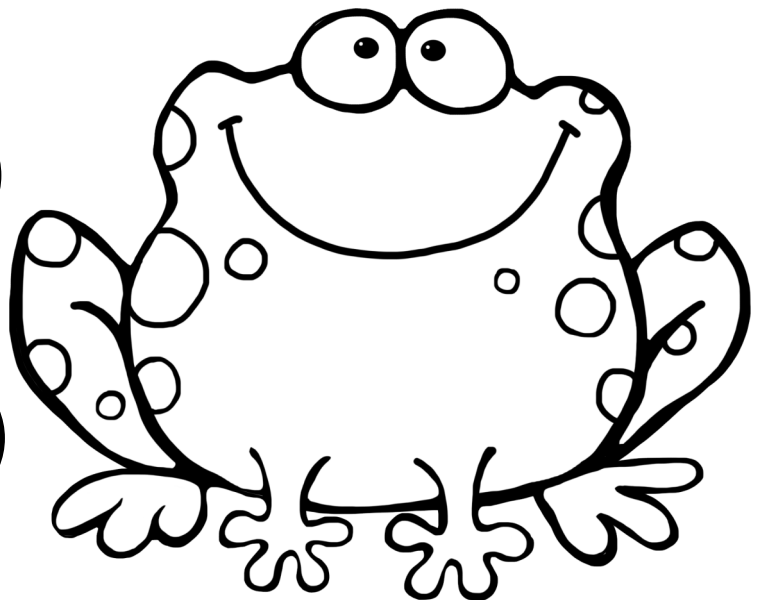

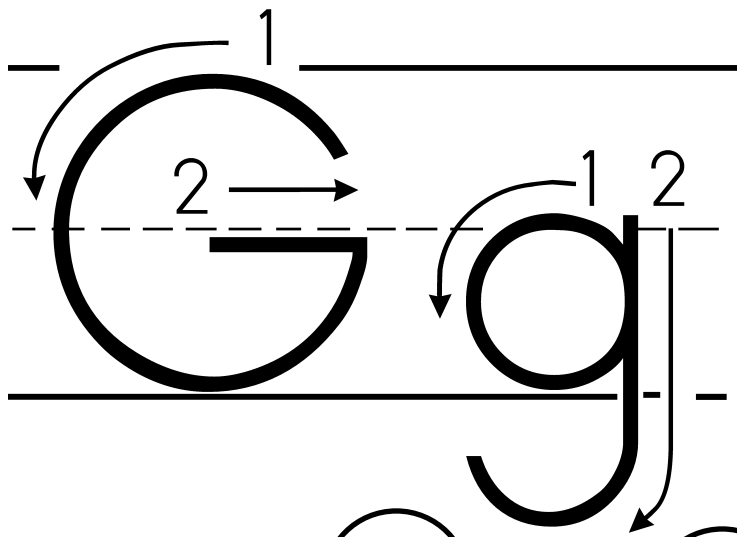

is for
gumballs

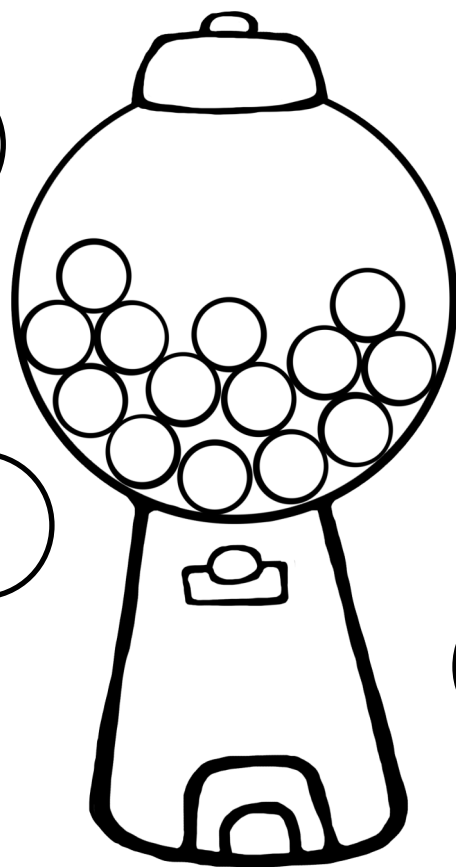
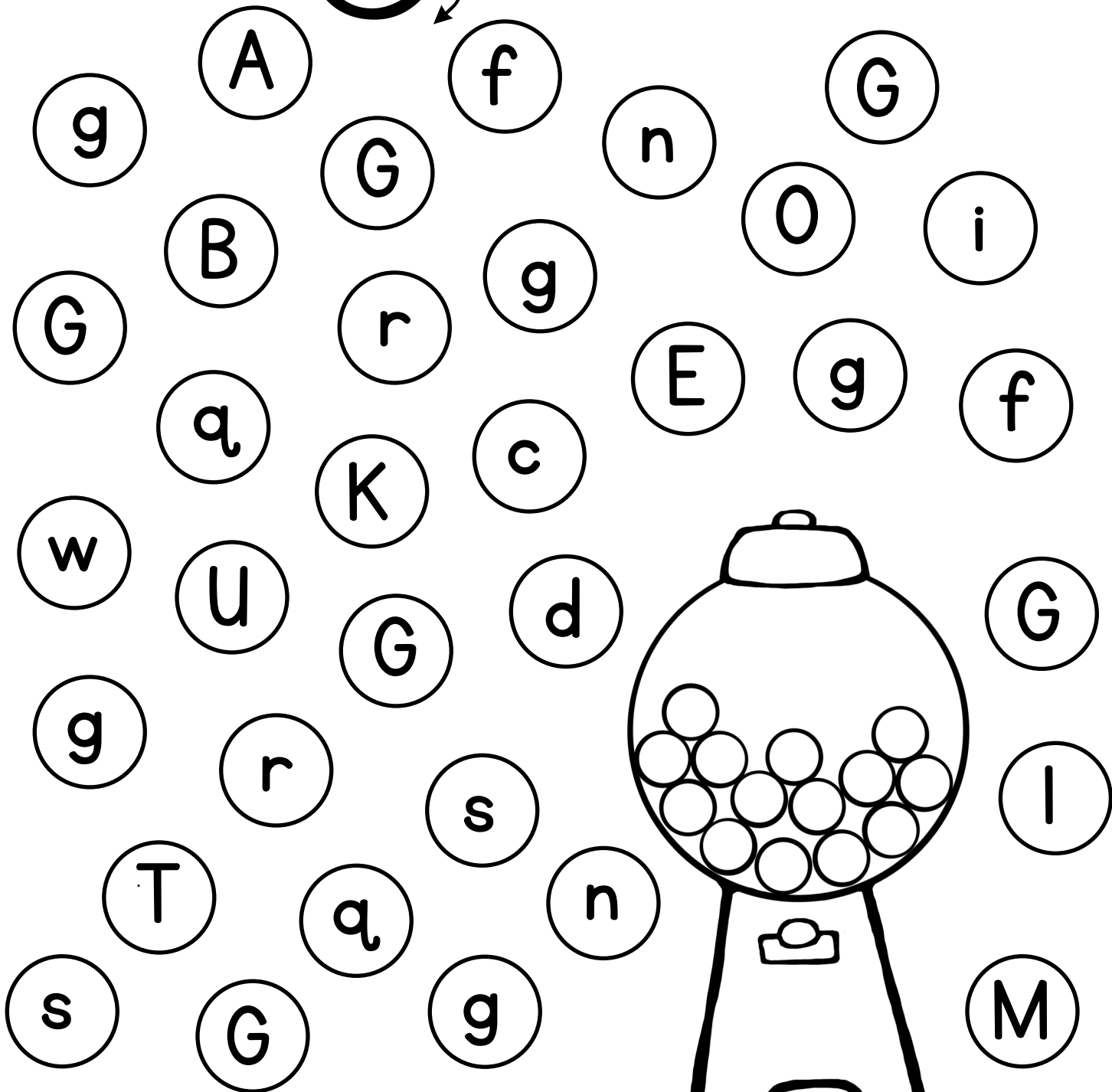

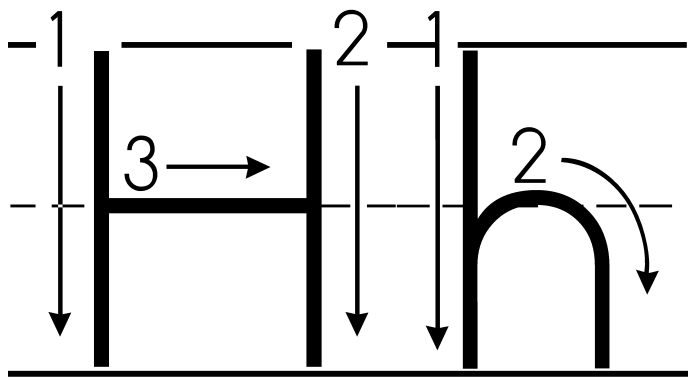

is for
hippo

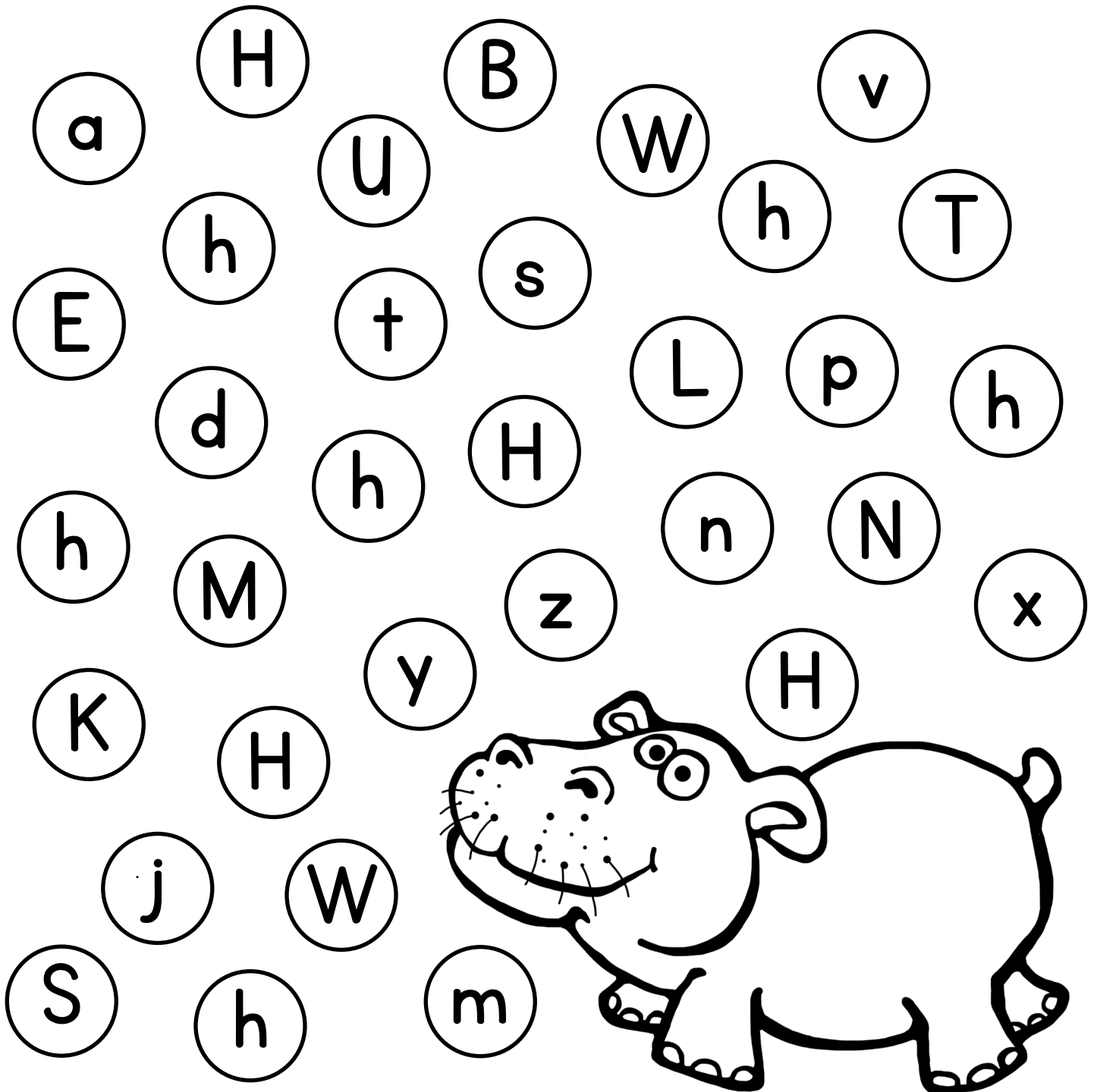

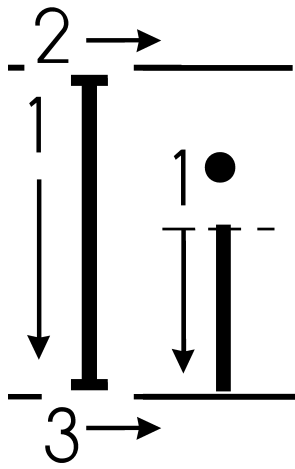

is for
igloo

A collection of letters in circles for a word search. The letters are: c, I, Z, b, i, l, p, i, x, i, e, S, D, Q, i, y, w, d, F, I, t, I, V, s, Z, M, R, k, I, g, j, i, r, H.

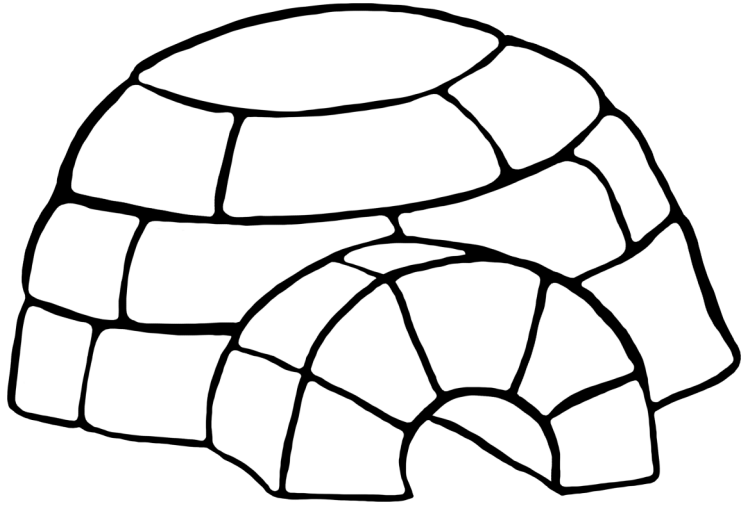

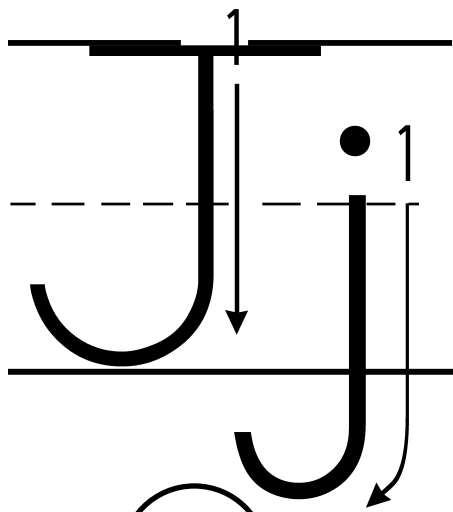

is for
jellyfish

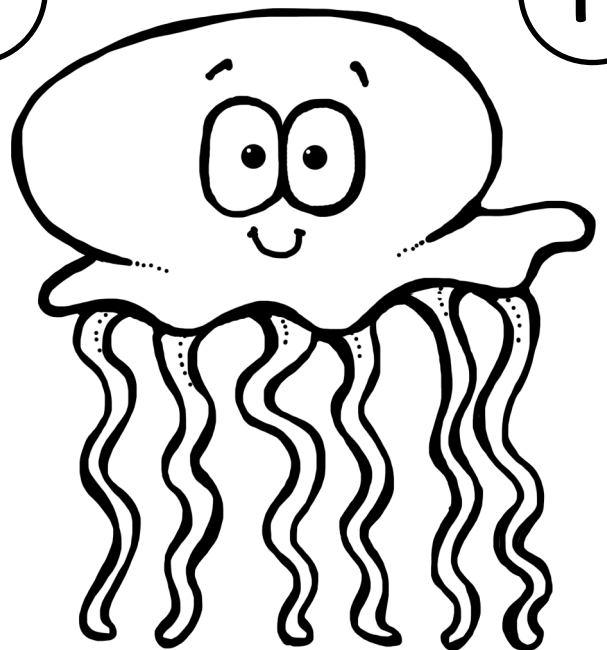
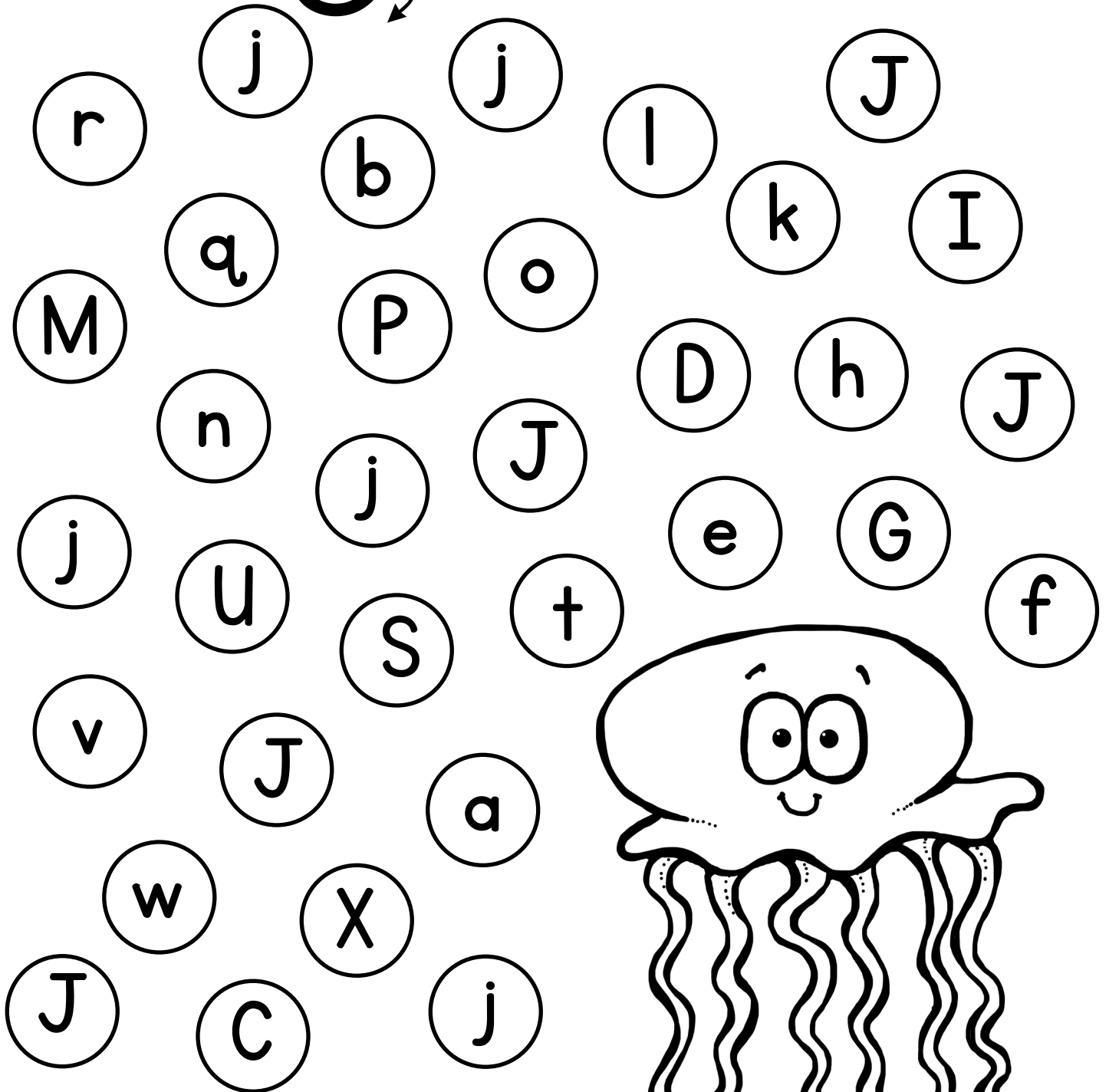

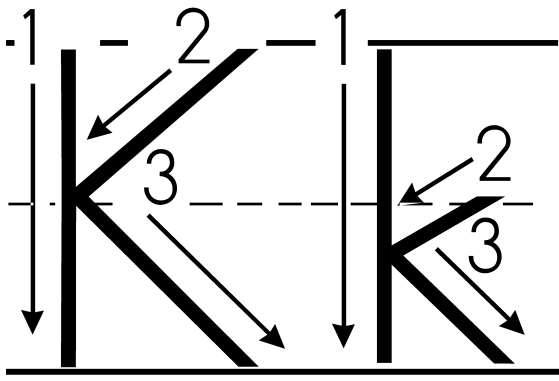

is for
koala

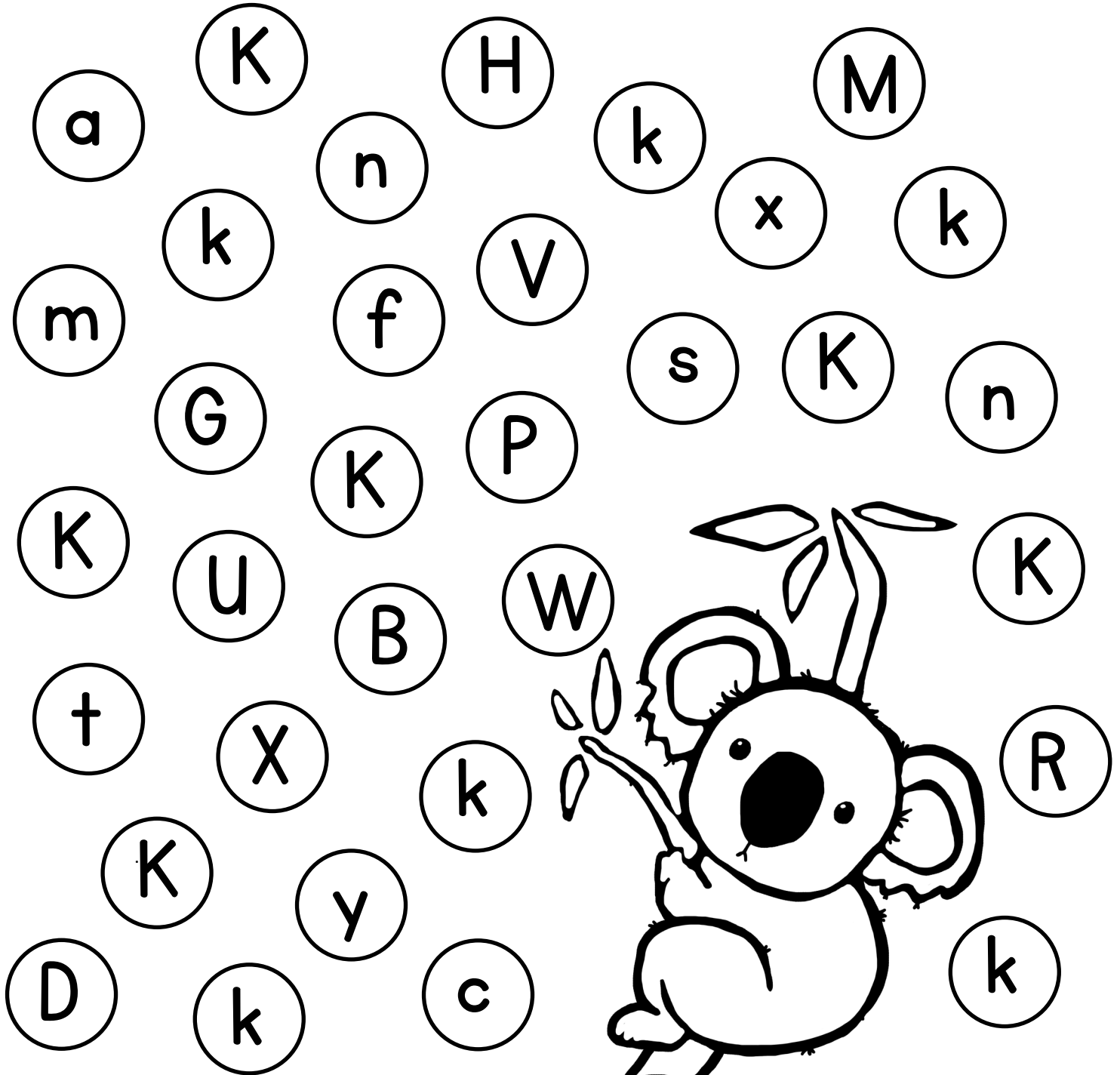

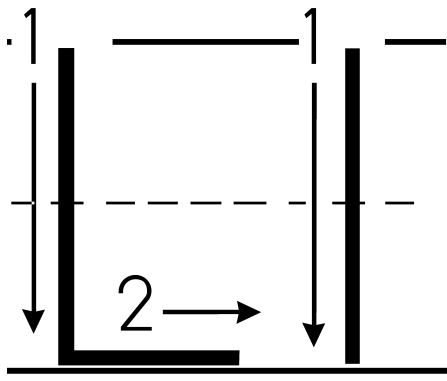

is for
lion

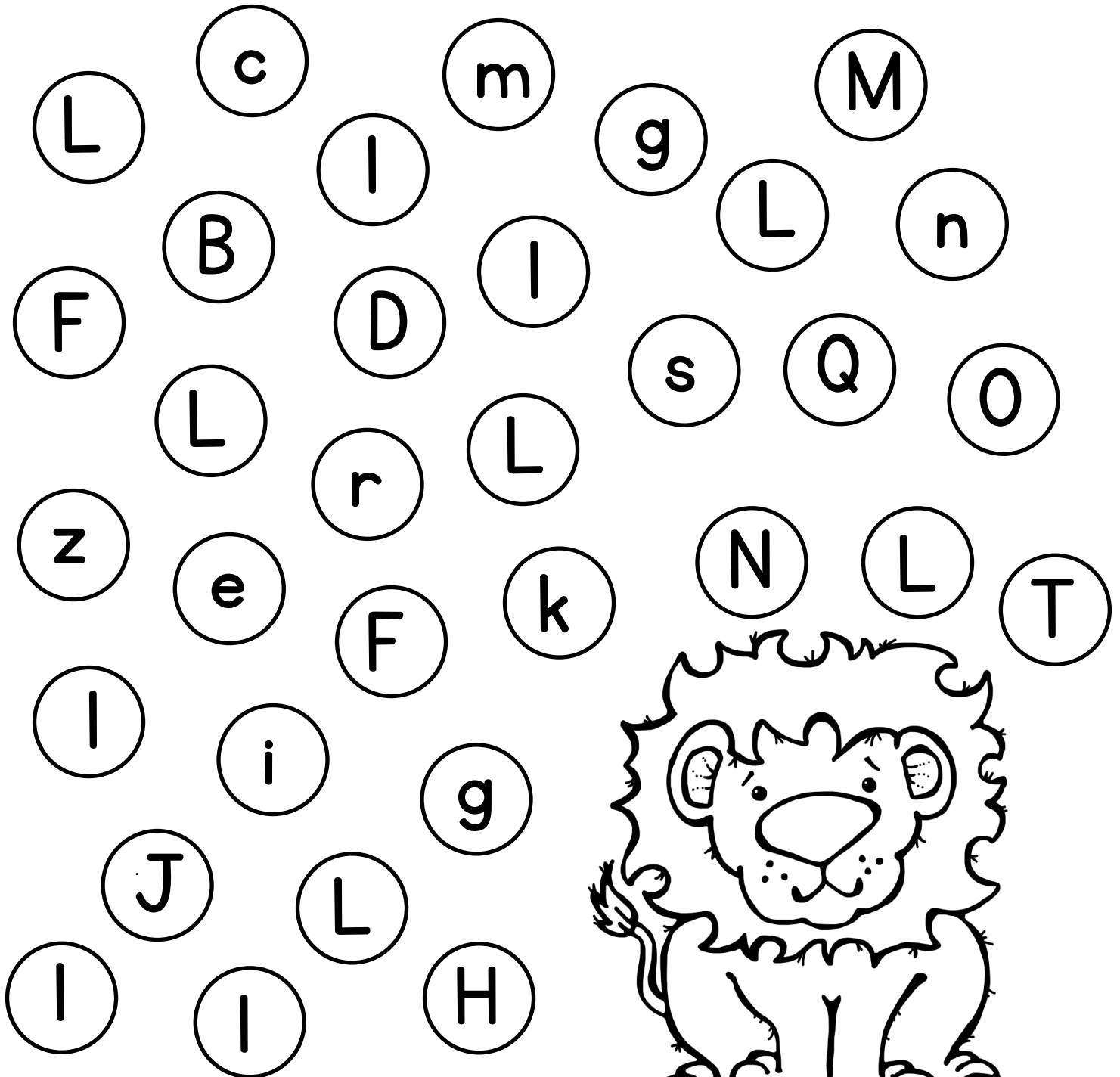

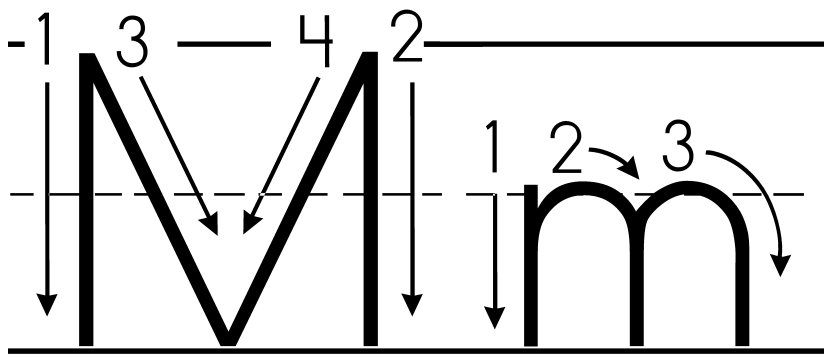

is for
mushroom

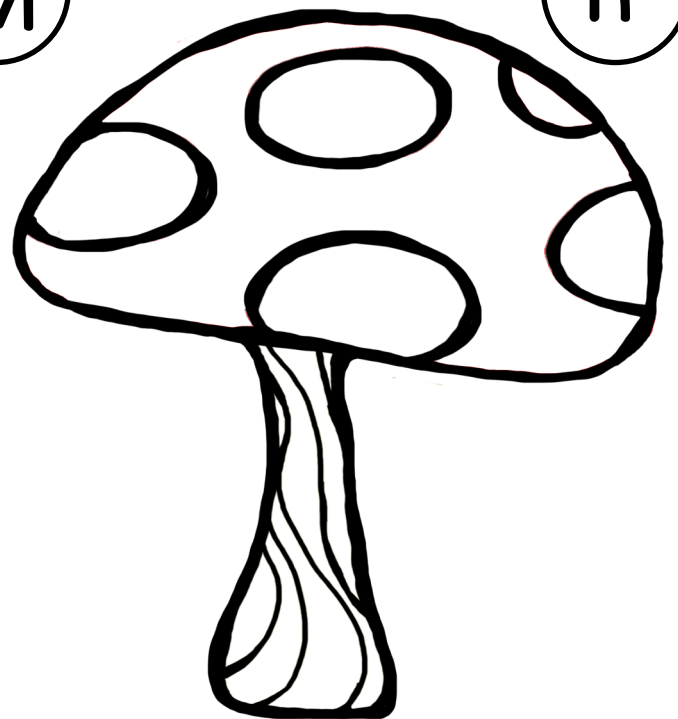
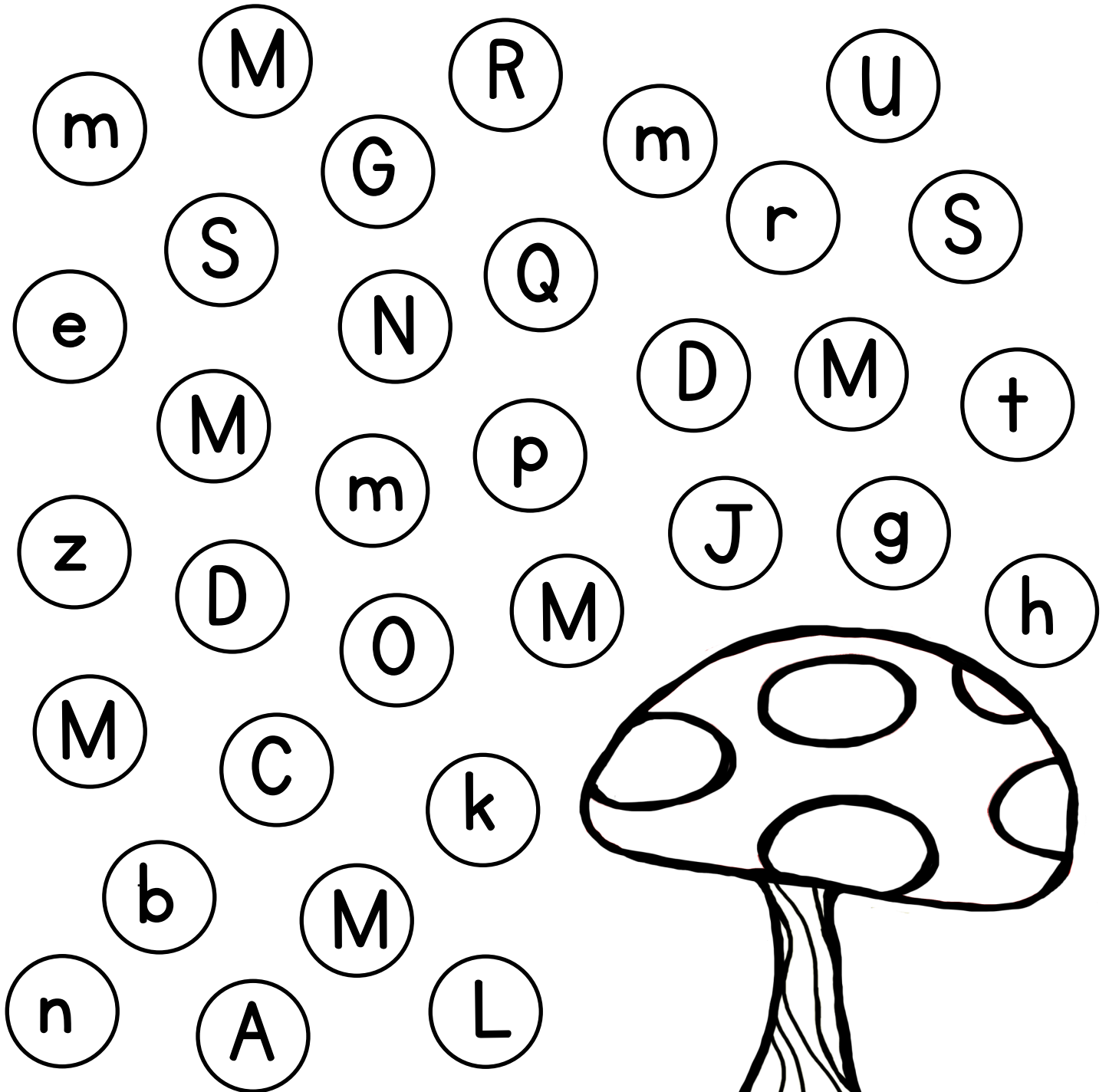

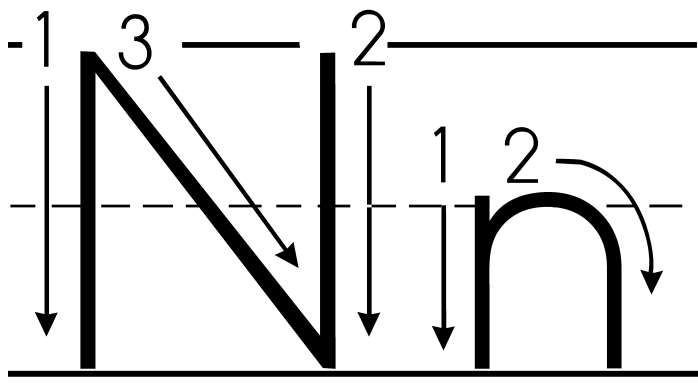

is for
nest

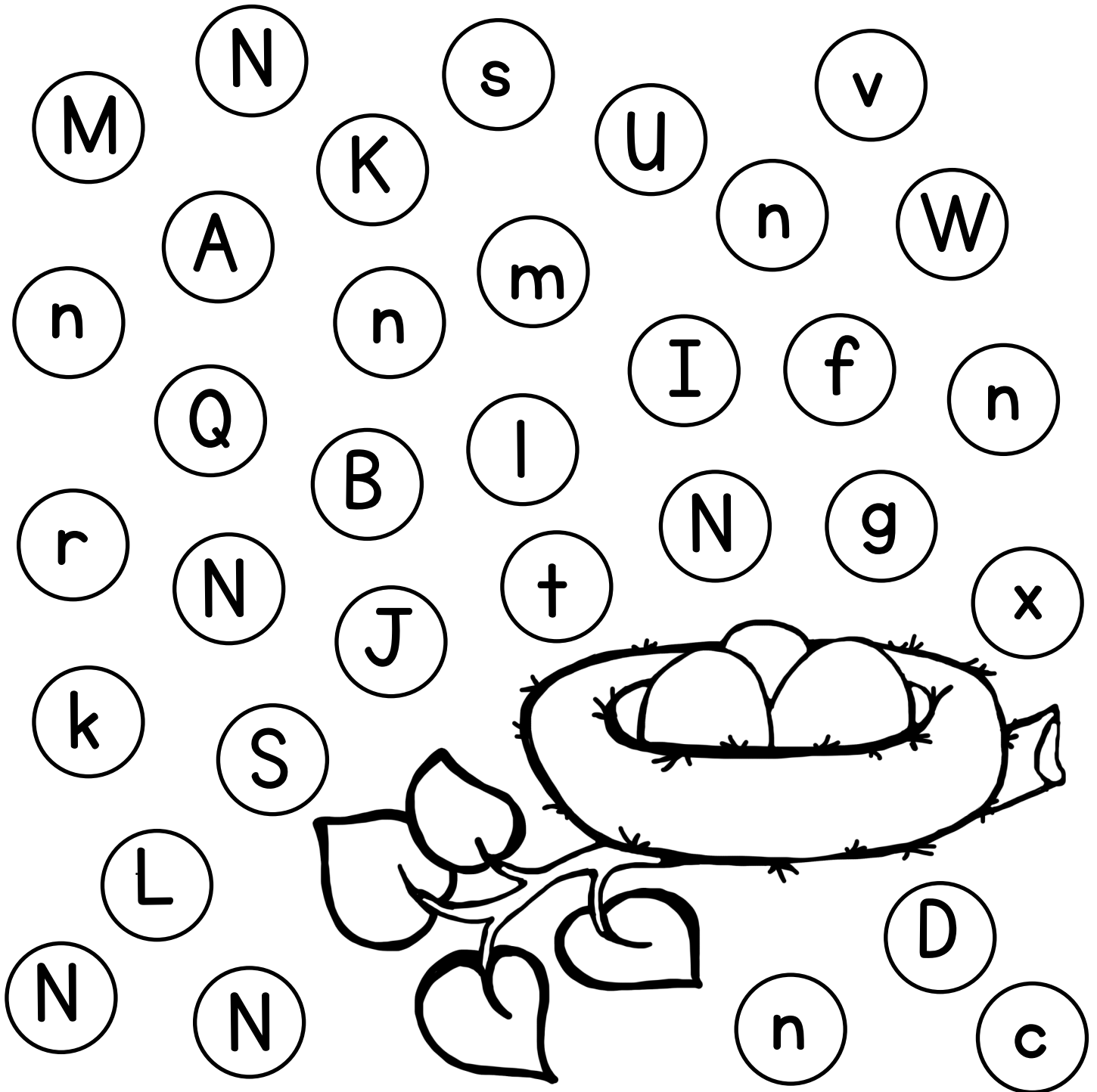

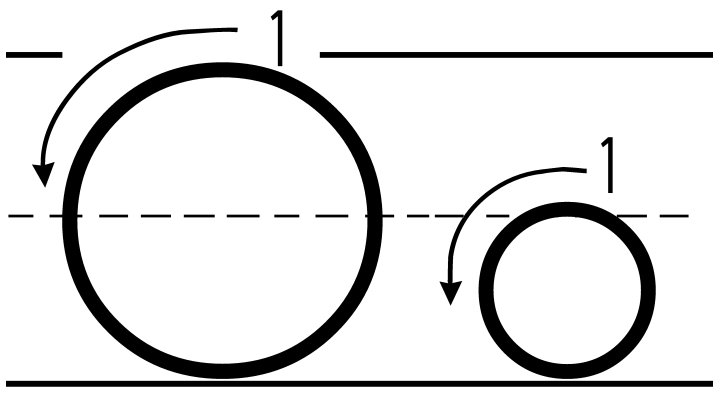

is for
octopus

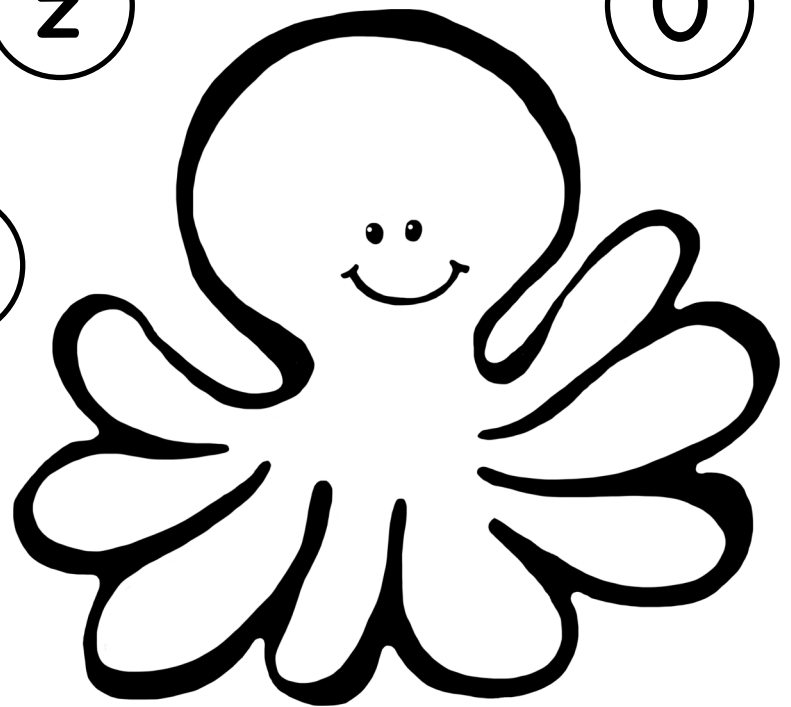
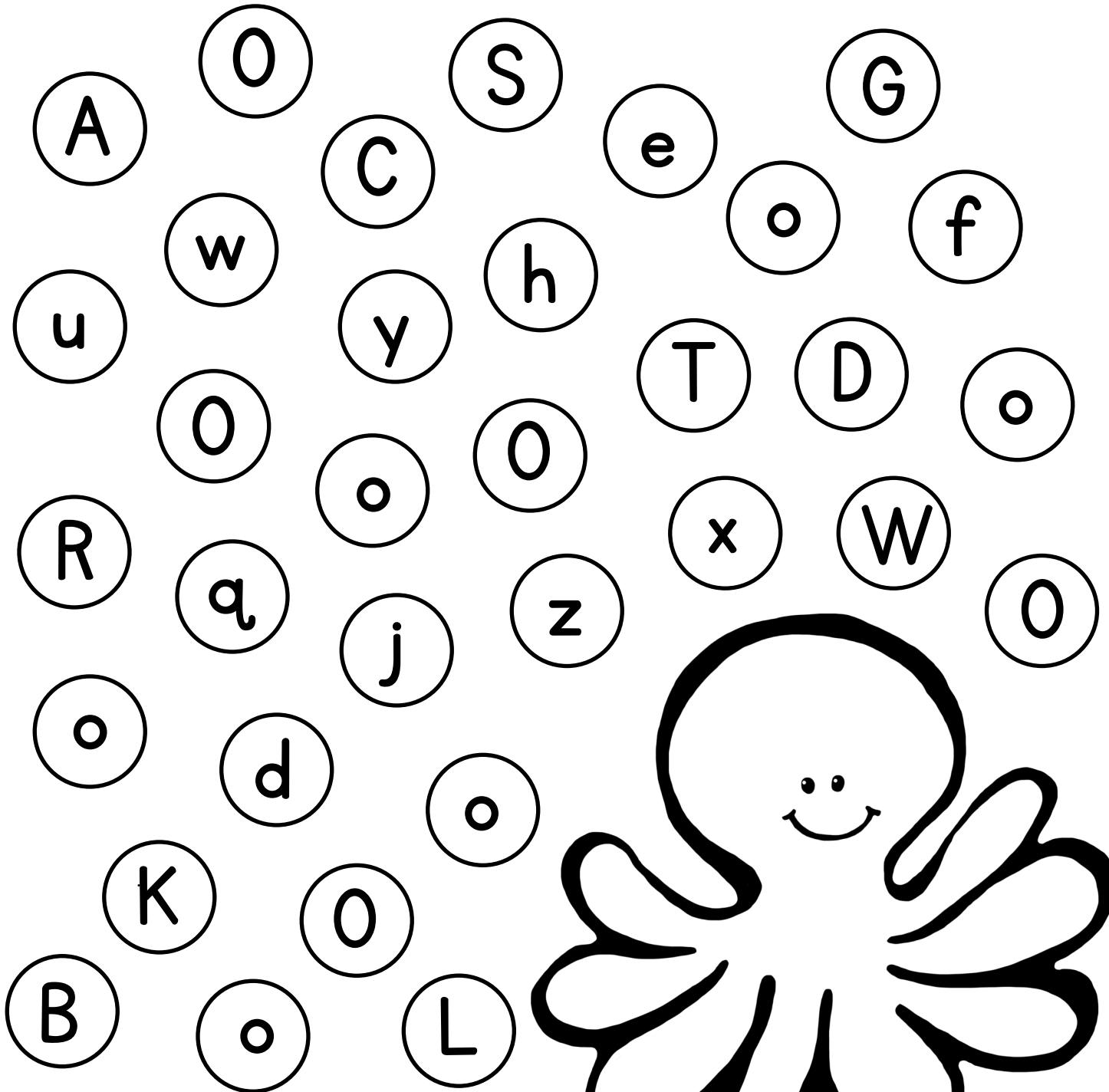

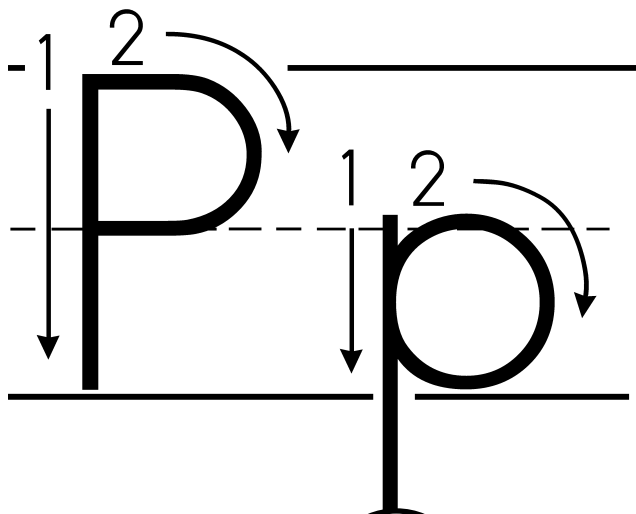

is for
pig

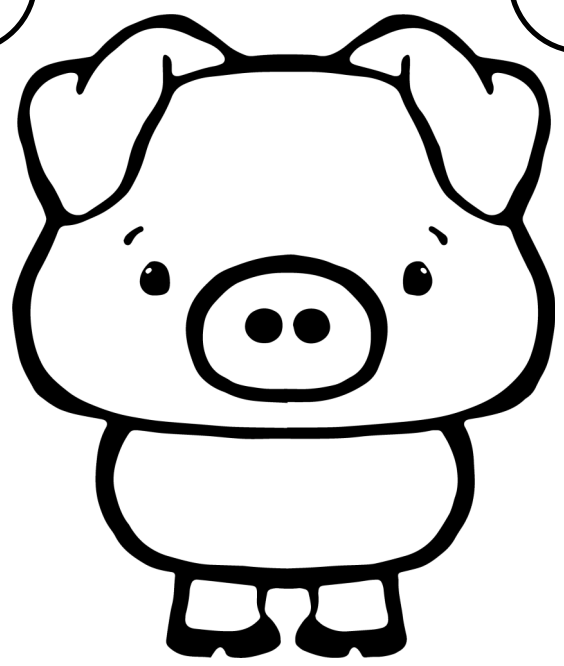
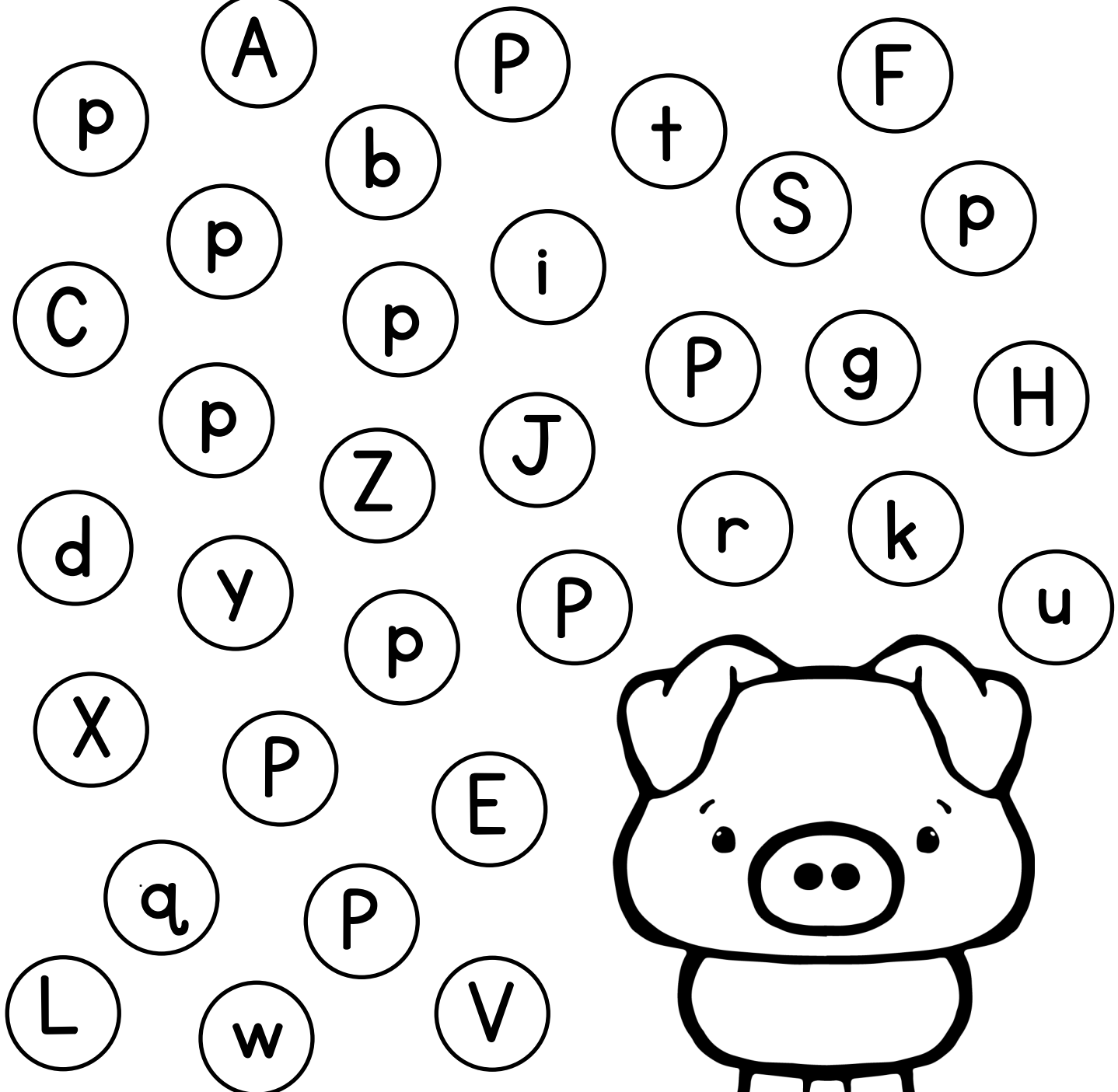

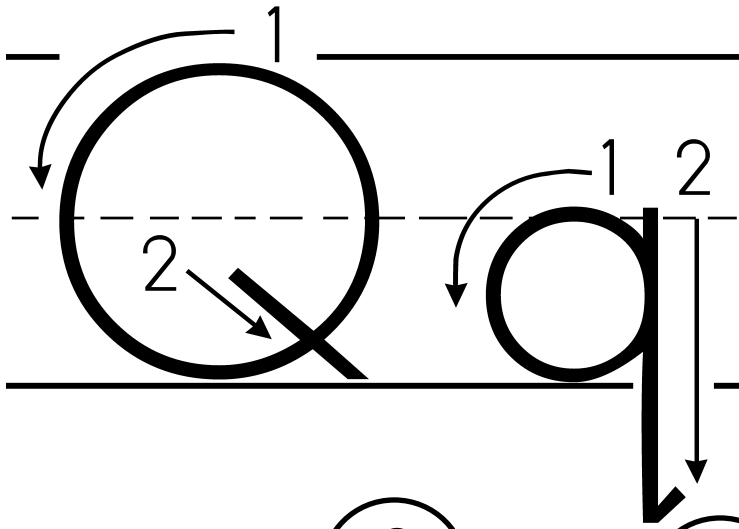

is for
queen

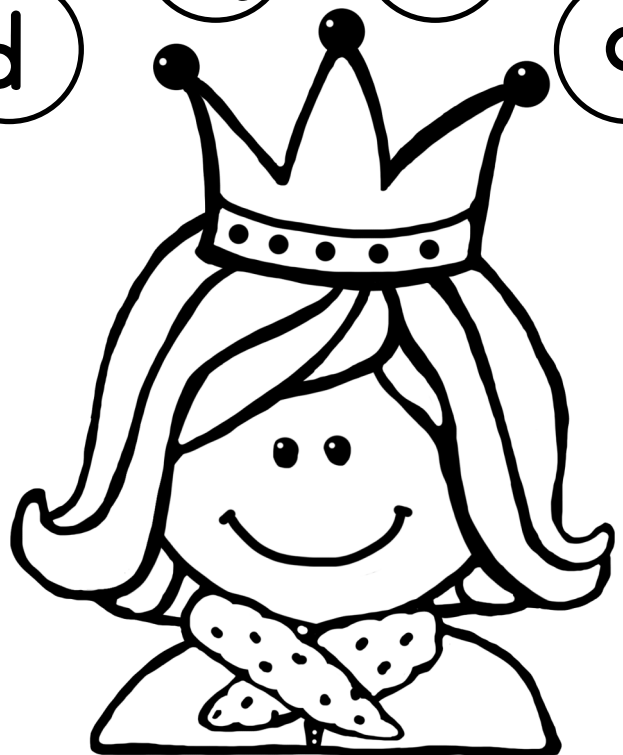
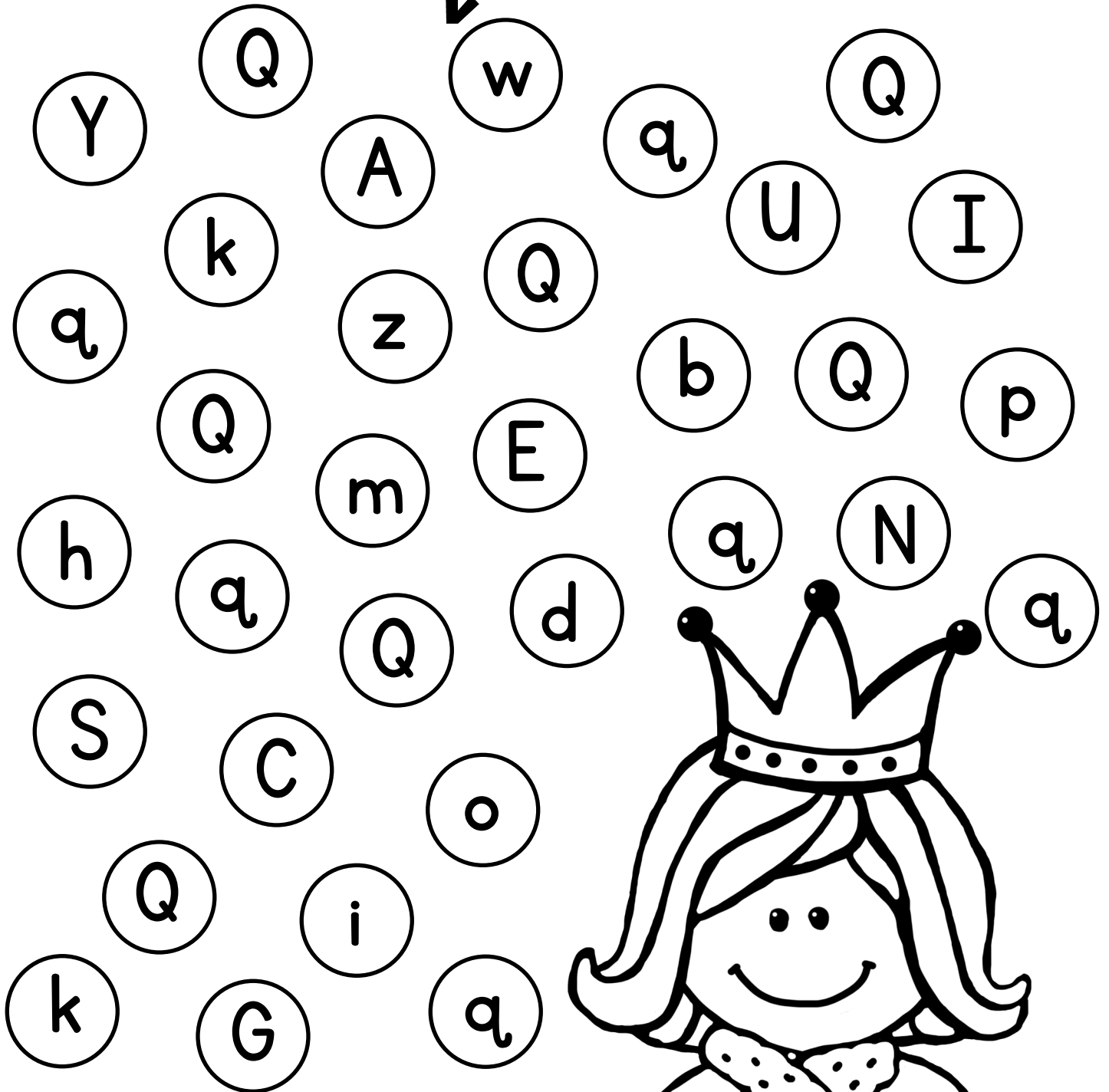

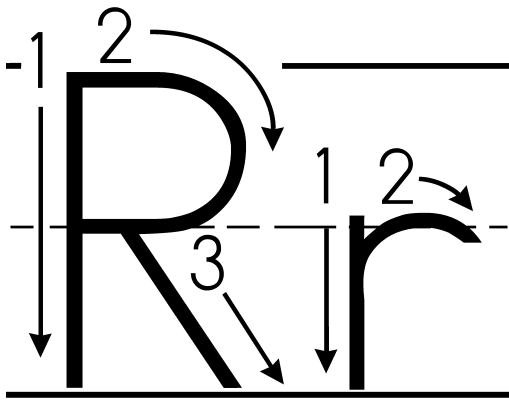

is for
rabbit

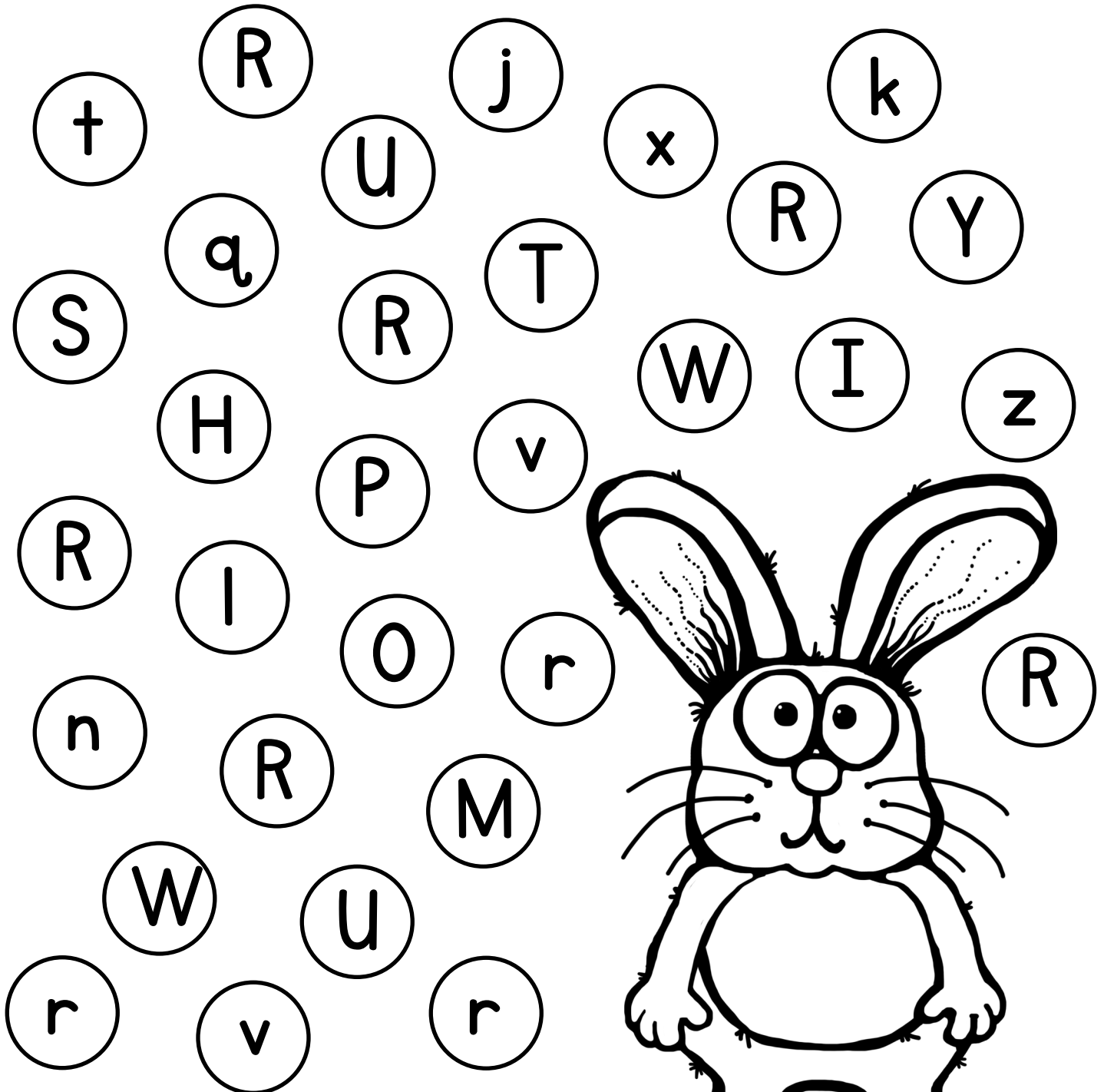

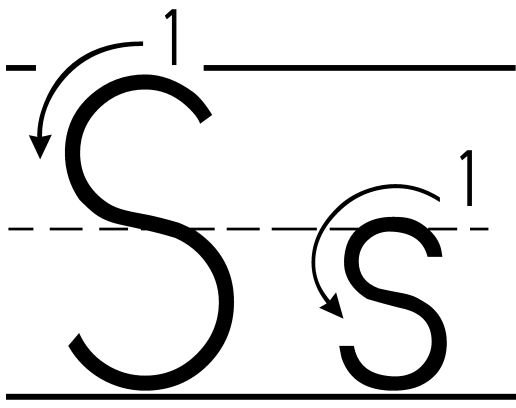

is for
snake

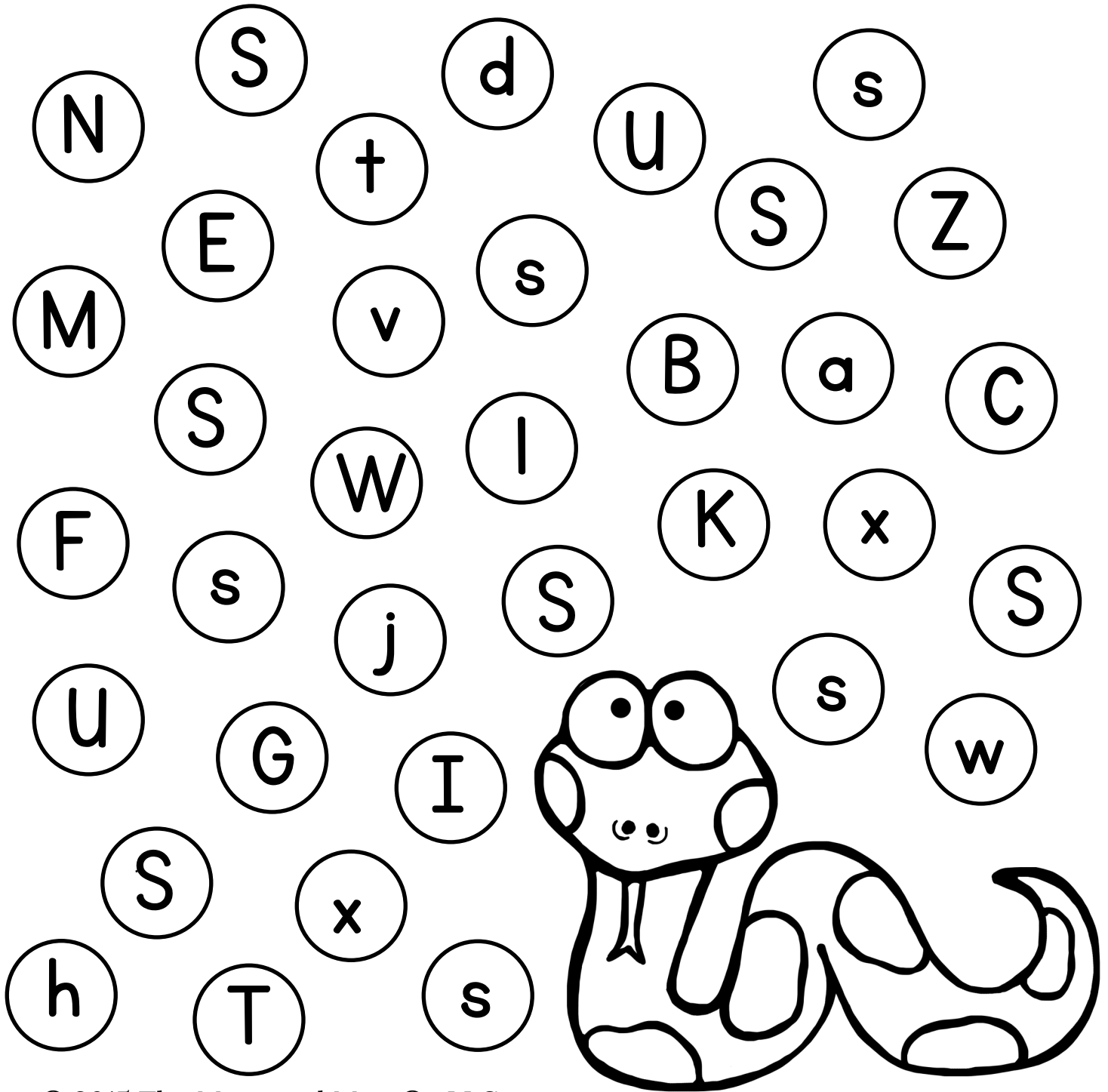

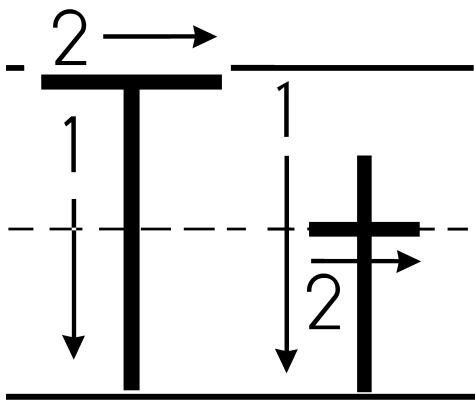

is for
turtle

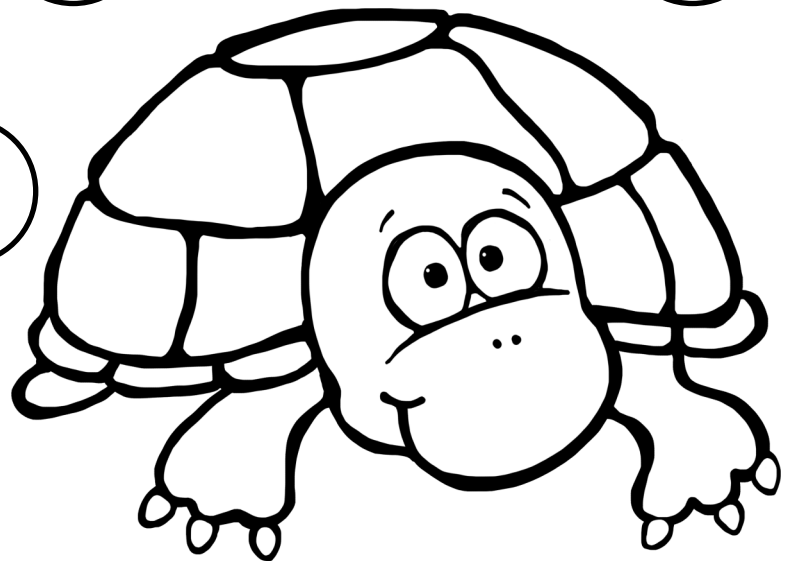
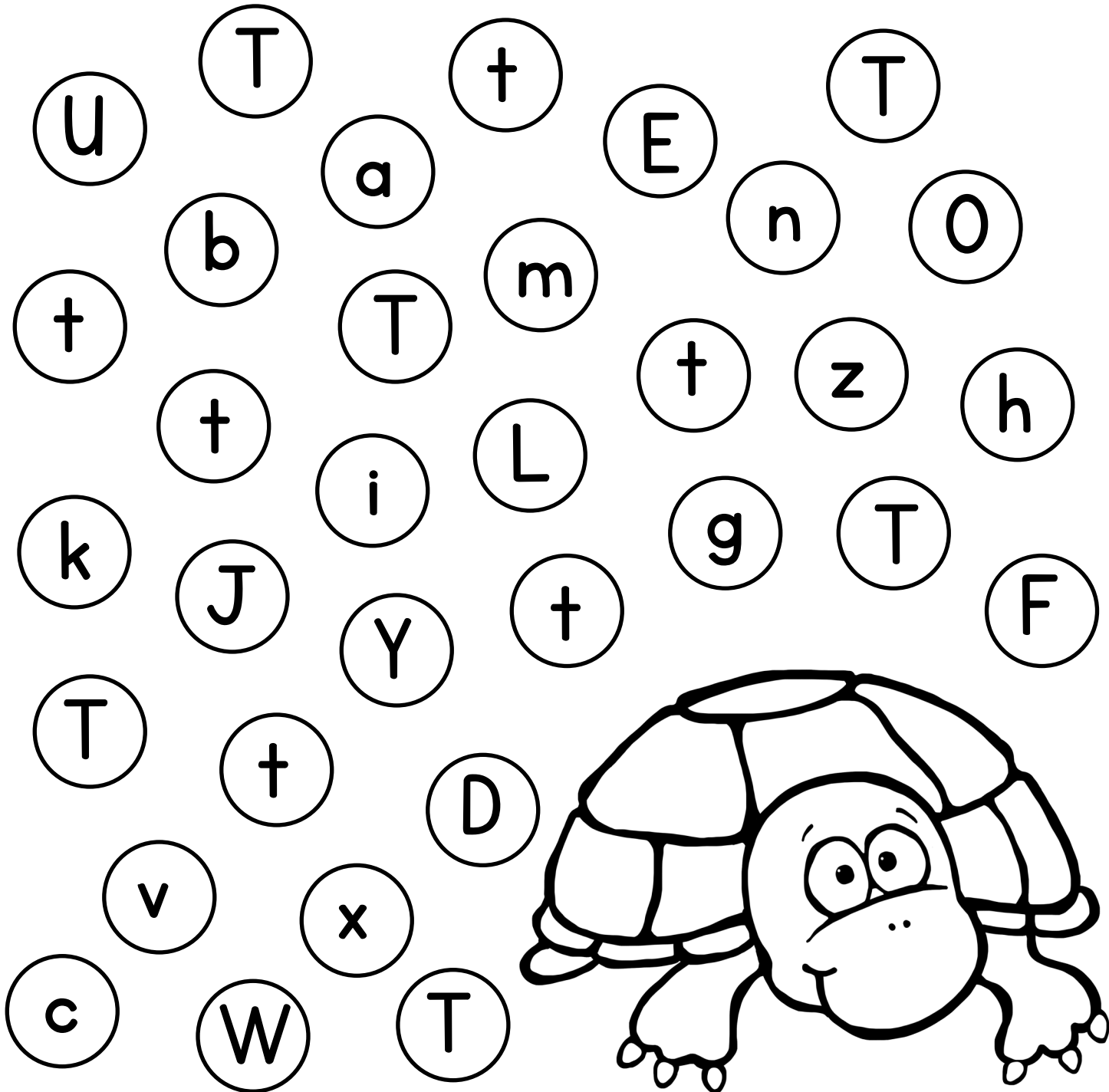

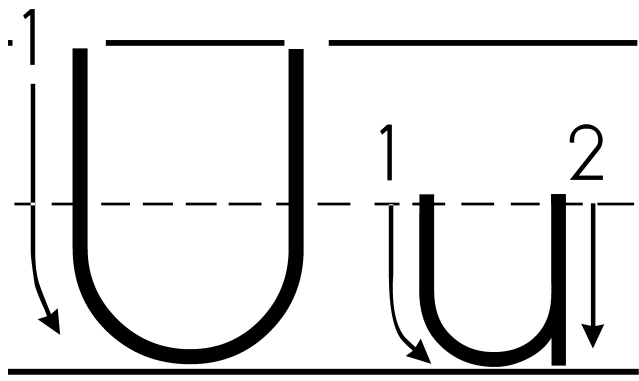

is for
umbrella

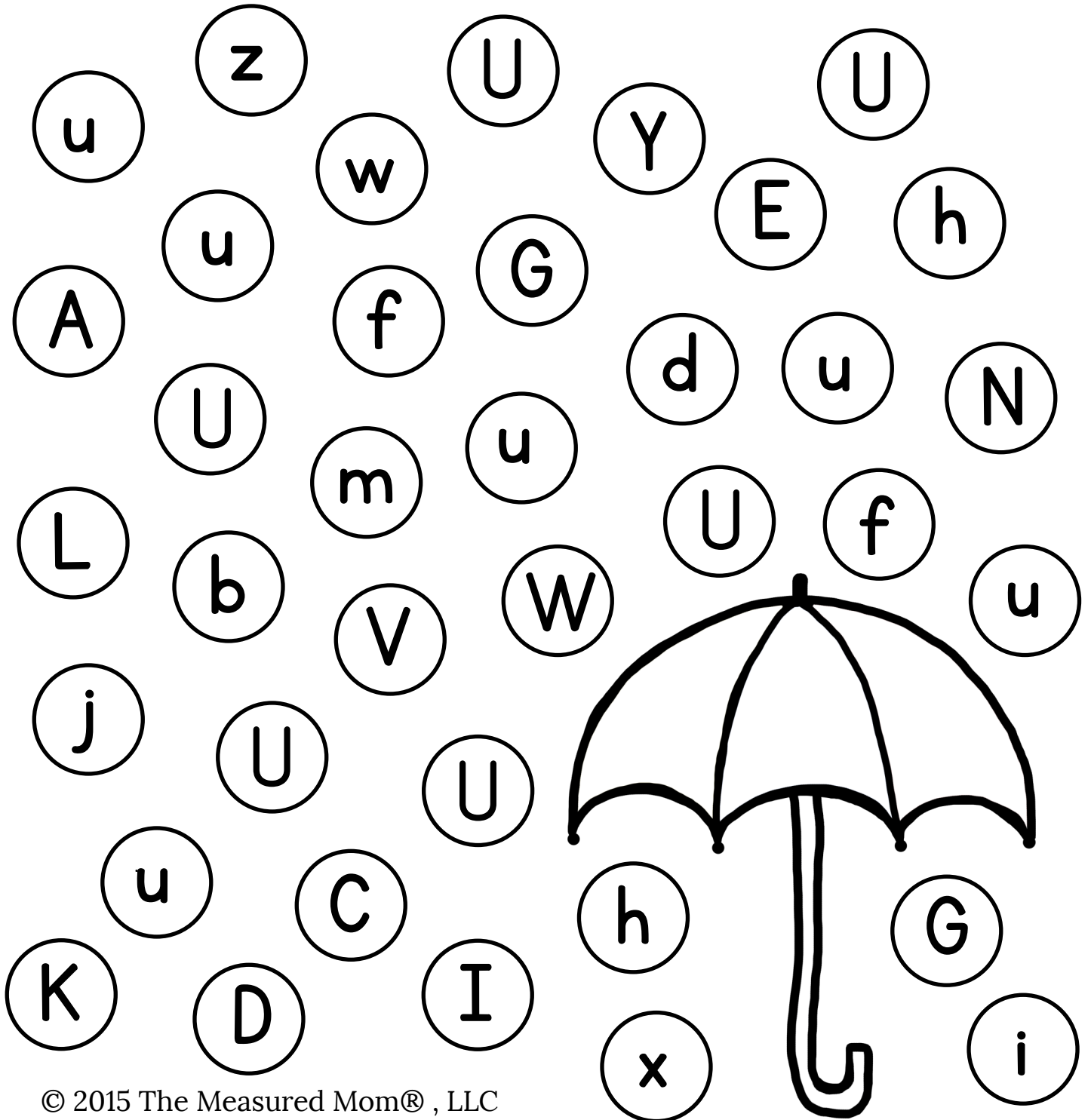

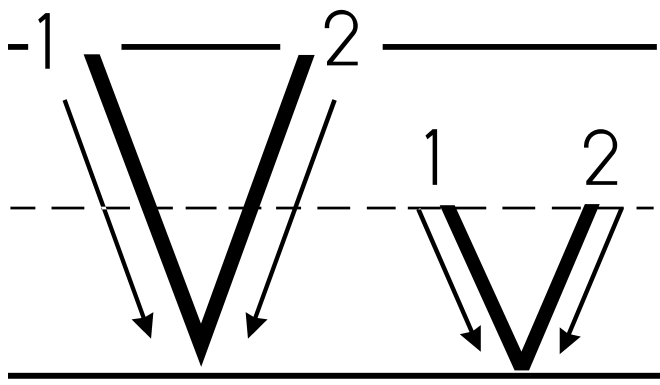

is for
volcano

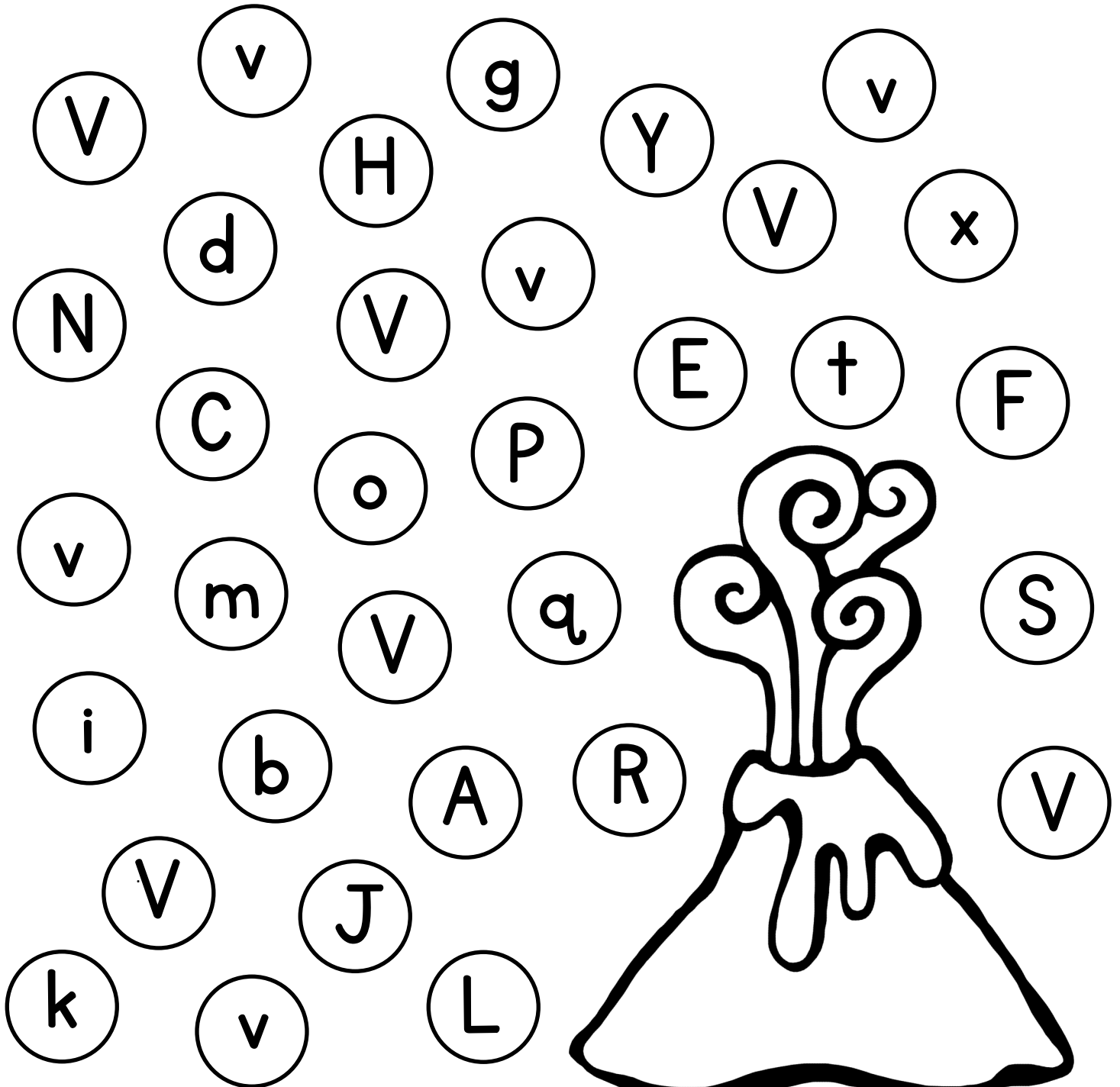

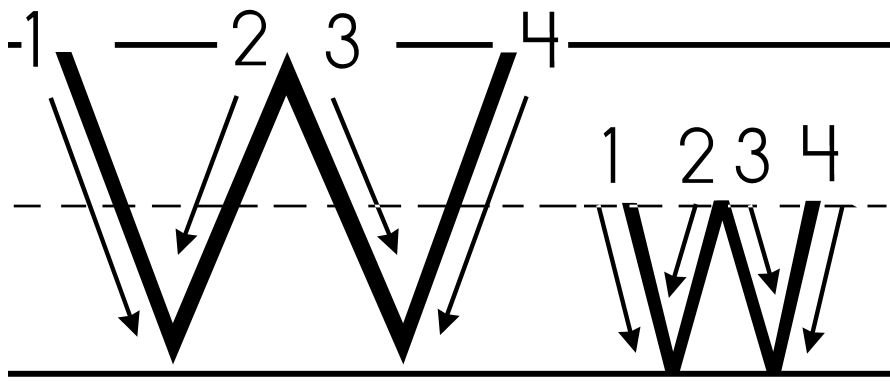

is for
whale

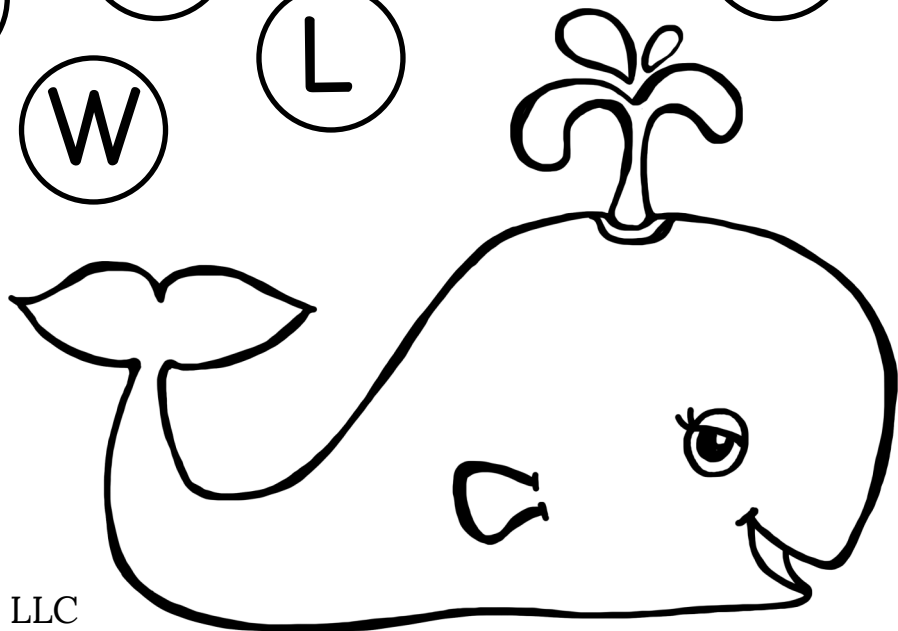
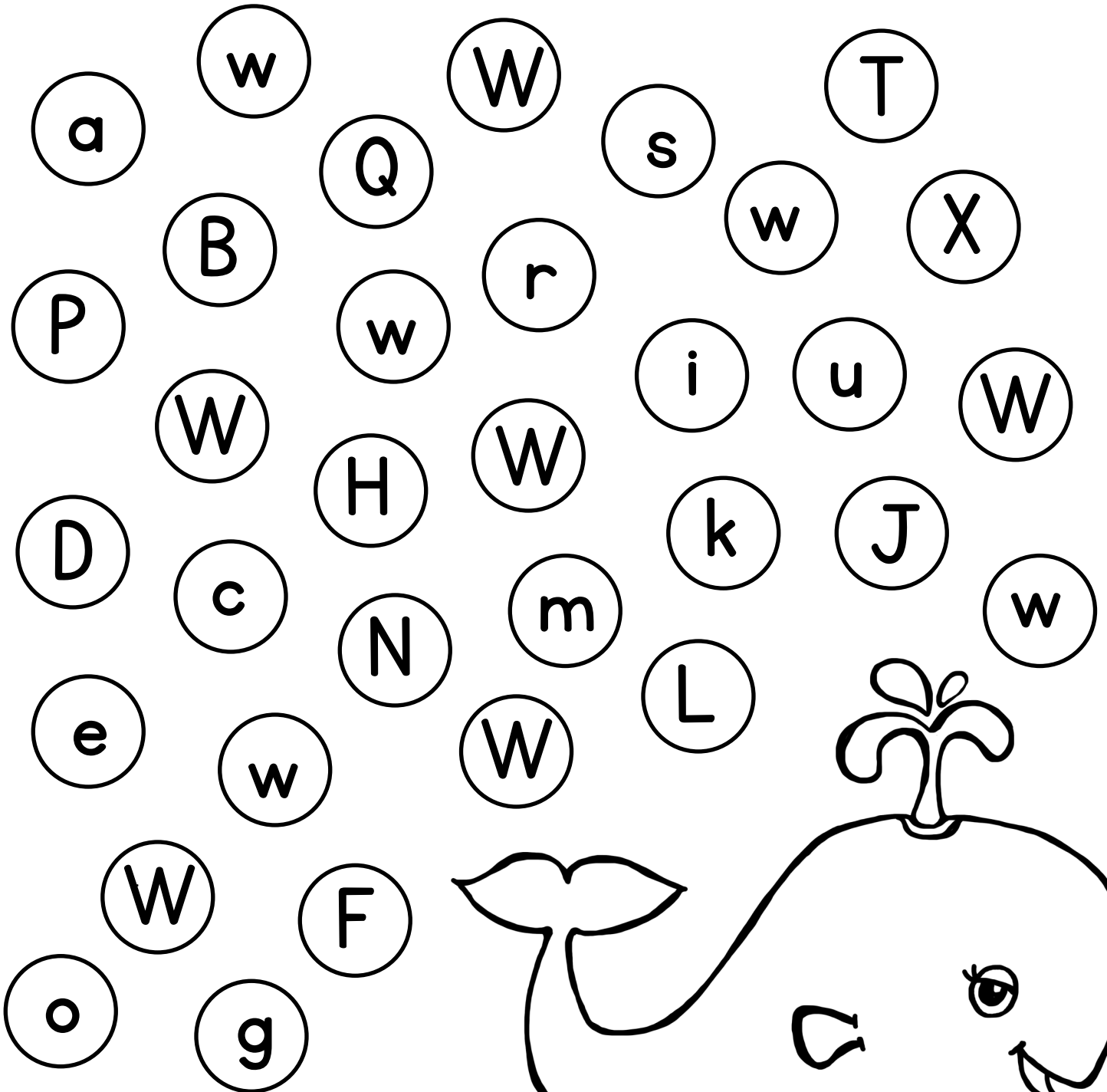

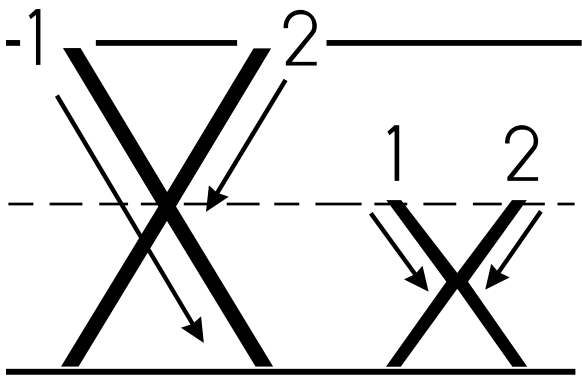

is for
x-ray

A collection of letters in circles for a word search. The letters are: X, m, I, X, x, e, Y, N, s, k, T, X, x, y, J, r, f, u, Z, V, H, x, Y, O, I, X, y, P, q, x, g.

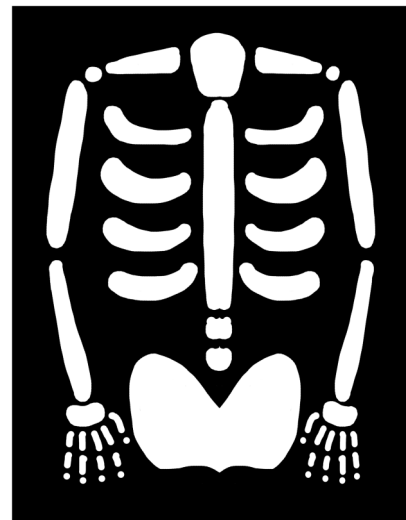

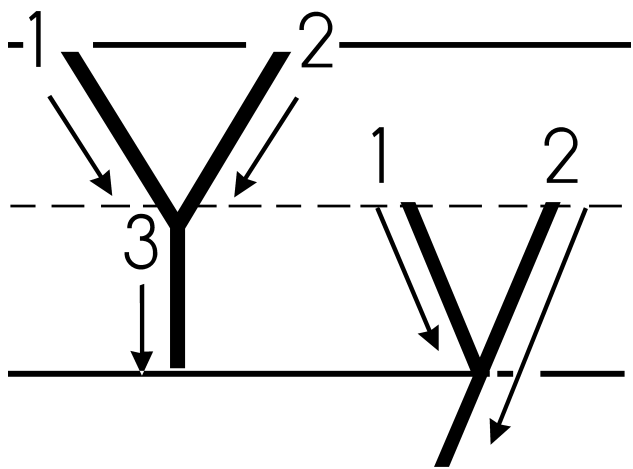

is for
yarn

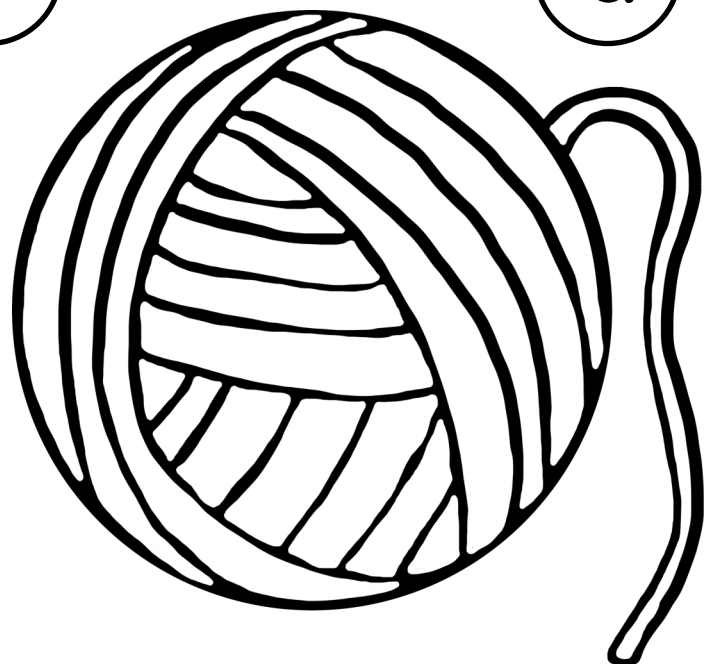
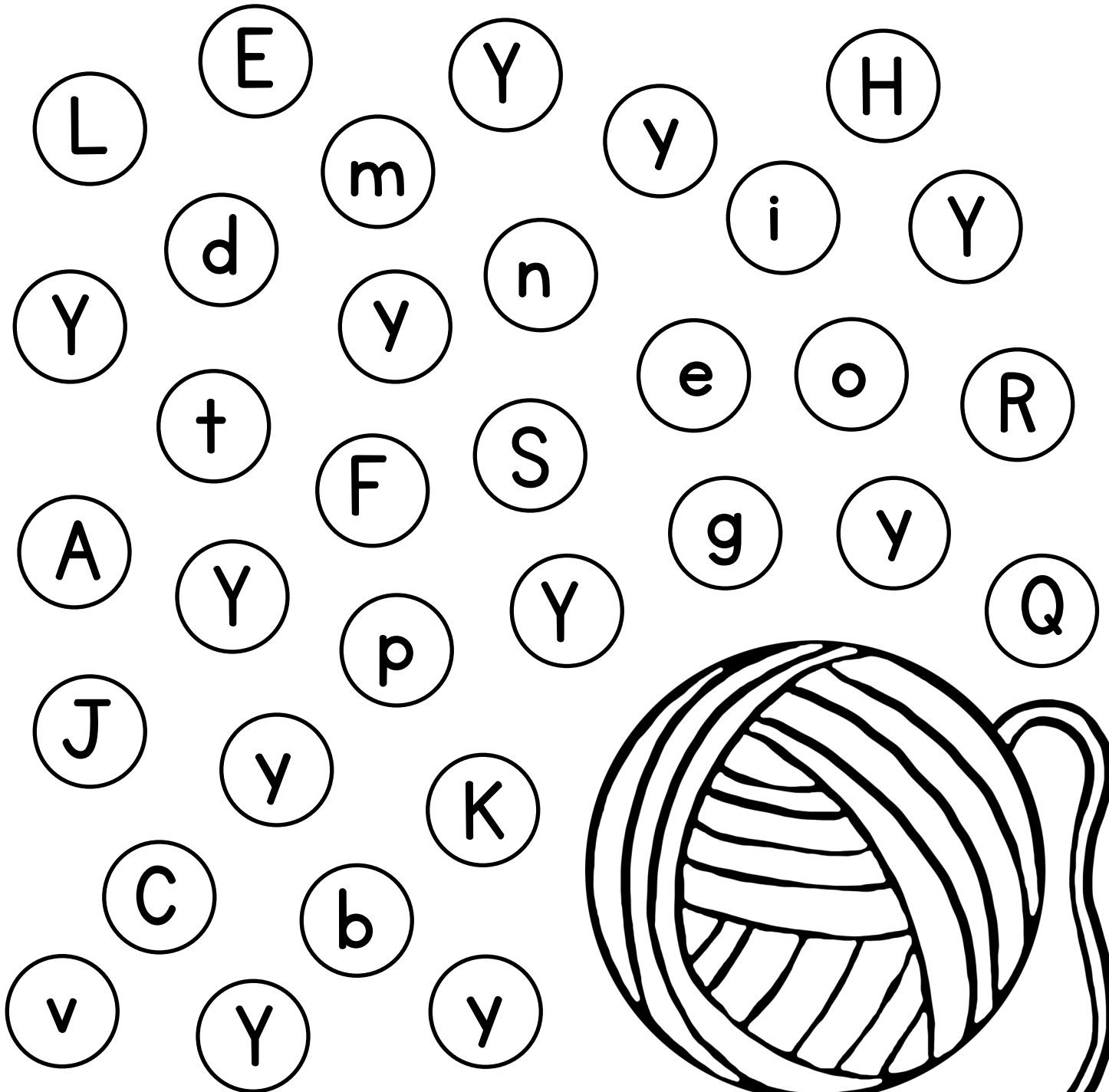

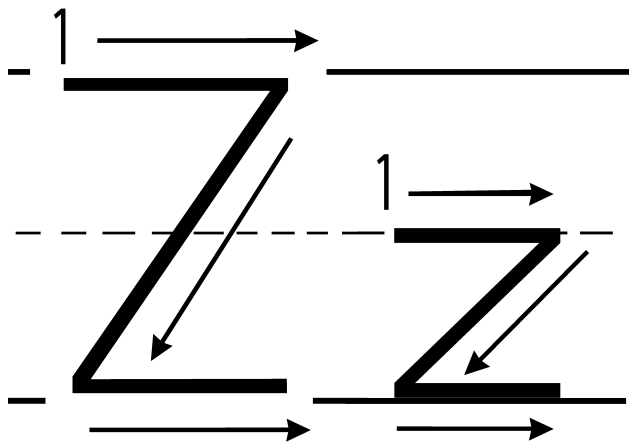

is for
zebra

